

YE-IT20
EUROPE
2020/2021



Wendeplatten



INDEXABLE INSERTS

 YG-1 CO., LTD.

INDEX

Contents		Page
Turning	External Turning Holder Code	4
	Internal Turning Holder Code	6
	Insert ISO Code System	8
	Turning Grades	10
	Turning Chipbreakers	12
	Application Guide	15
	Formulas	20
	Surface Roughness Guide	21
	Trouble Shooting	22
	External Holders Overview	25
	Internal Holders Overview	27
	Product External Holders	29
	Internal Holders	44
	Inserts Overview	59
Product Negative Inserts	60	
Positive Inserts	78	
Parting & Grooving	Overview	86
	Product Parting & Grooving Inserts	87
Milling	Milling Cutter Code Keys	89
	Insert ISO Code System	90
	Milling Cutter Overview	92
	Milling Inserts Overview	94
	Milling Grades and Chipbreakers	95
	Product Face Milling Cutters	96
	Face Milling Inserts	102
	Shoulder Milling Cutters	113
	Shoulder Milling Inserts	121
	Profiling Cutters	126
	Profiling Inserts	129
	High Feed Milling Cutters	133
	High Feed Milling Inserts	134
	Taper Milling Cutters	135
Taper Milling Inserts	136	
Modular Shank	137	
Drilling	Drilling Overview	139
	Product Drill Holder	140
	Drilling Inserts	146
Technical Information	ISO 13399 Terms	149
	Hardness Conversion Table	150
	Material Groups	151
	Comparison Chart - Turning	168
	Comparison Chart - Milling	170
Search	171	



ISO TURNING

Product Overview

Application Guide

Turning Holders Overview

Turning Holders

Turning Inserts Overview

Turning Inserts

Turning - Name Code System

External Turning Holder Code (Metric)







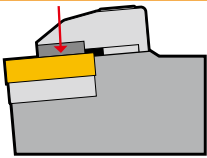
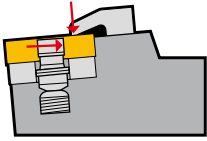
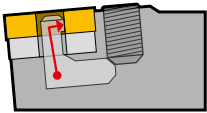
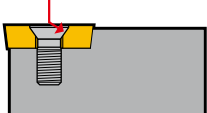
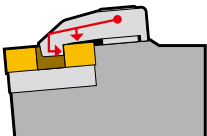

*Metric

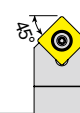
1	2	3	4	5	6	7	8	9	10
P	C	L	N	R	25	25	M	12	(C)
Clamping System	Insert Shape (1st Letter of Insert)	Tool Style	Insert Clearance (2nd Letter of Insert)	Tool Hand	Shank Height (H)	Shank Width (B)	Length (LF)	Insert Size	(Optional Clamp)

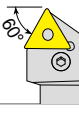
1 - Clamping System

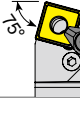
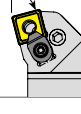
Symbol	System
C	 Top Clamp (No Clamping Hole Insert)
M	 Pin & Top Clamp (Straight Clamping Hole Insert)
P	 Lever Lock (Straight Clamping Hole Insert)
S	 Screw (Screw Clamping Hole Insert)
T (D, A)	 Hole Clamp (Straight Clamping Hole Insert)

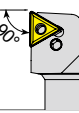
3 - Tool Style

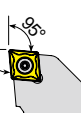
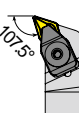
Approach Angle (KAPR)	Side Direction		End Direction
	Straight Shank	Offset Shank	
45°	D 	S 	
60°		T 	
63°	N 		
72.5°	V 		
75°	B 		K 
90°	A 	G 	F 
93°		J 	U
95°		L (Both Direction) 	
107.5°		H 	

2, 4 — Insert Compatibility *



* Related to Insert Designation to check compatibility

Turning - Name Code System

External Turning Holder Code (Metric)

*Metric

1	2	3	4	5	6	7	8	9
S	D	J	C	R	20	20	K	11
Clamping System	Insert Shape (1st Letter of Insert)	Tool Style	Insert Clearance (2nd Letter of Insert)	Tool Hand	Shank Height (H)	Shank Width (B)	Length (LF)	Insert Size

5 - Hand Direction

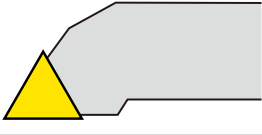
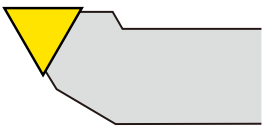
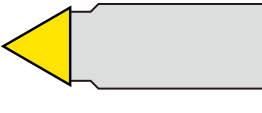
Symbol	Hand Direction
R	Right Hand 
L	Left Hand 
N	Neutral 

8 - Length (LF)

Symbol	Length (mm)	Symbol	Length (mm)
E	70	Q	180
F	80	R	200
H	100	S	250
K	125	T	300
M	150	U	350
P	170	V	400
M	150	U	350
P	170	V	400

6, 7 - Shank Height (H) Shank Width (B)

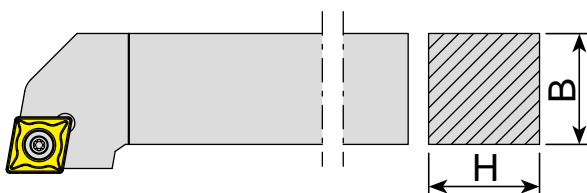

9 - Insert Size *

Examples	is Compatible with...
PCLNR 2525M 12	CNMG 120408
SCLCR 2020K 09	CCMT 09T308
TWLNR 2525M 08	WNMG 080408

* Related to Insert Designation to check compatibility

(10 - Optional Clamp)

Symbol	Optional Clamp
C	Included

Turning - Name Code System

Internal Turning Holder Code (Metric)

*Metric

1	2	3	-	4	5	6	7	8	9	10
A	32	S	-	P	W	L	N	R	12	(C)
Coolant & Material	Shank Diameter (DCON)	Legth (LF)		Clamping System	Insert Shape (1st Letter of Insert)	Tool Style	Insert Clearance (2nd Letter of Insert)	Tool Hand	Insert Size	(Optional Clamp)

1 - Coolant and Tool Material

Symbol	Internal Coolant	Tool Material
A	O	Steel
S	X	
E	O	Carbide

2 - Shank Diameter (DCON)

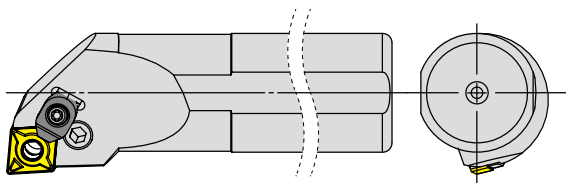

3 - Length (LF)

Symbol	Length (mm)	Symbol	Length (mm)
E	70	Q	180
F	80	R	200
H	100	S	250
K	125	T	300
M	150	U	350
P	170	V	400
M	150	U	350
P	170	V	400

4 - Clamping System

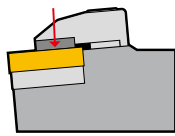
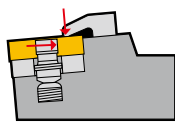
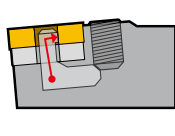
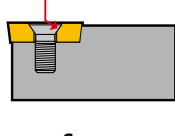
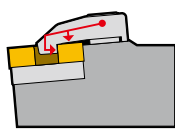
Symbol	System
C	 Top Clamp (No Clamping Hole Insert)
M	 Pin & Top Clamp (Straight Clamping Hole Insert)
P	 Lever Lock (Straight Clamping Hole Insert)
S	 Screw (Screw Clamping Hole Insert)
T (D, A)	 Hole Clamp (Straight Clamping Hole Insert)

Turning - Name Code System

Internal Turning Holder Code (Metric)

*Metric

1	2	3	4	5	6	7	8	9
A	25	R	-	S	C	L	C	09
Coolant & Material	Shank Diameter (DCON)	Legth (LF)	Clamping System	Insert Shape (1st Letter of Insert)	Tool Style	Insert Clearance (2nd Letter of Insert)	Tool Hand	Insert Size

6 - Tool Style

Approach Angle (KAPR)	Side Direction	End Direction
	Offset Shank	
75°		K
90°		F
93°	J	U
95°	L (Both Direction)	
107.5°		Q

8 - Hand Direction

Symbol	Hand Direction
R	Right Hand
L	Left Hand
N	Neutral

9 - Insert Size *

Examples	is Compatible with...
PCLNR 2525M 12	CNMG 120408
SCLCR 2020K 09	CCMT 09T308
TWLNR 2525M 08	WNMG 080408

* Related to Insert Designation to check compatibility

5, 7 - Insert Compatibility *

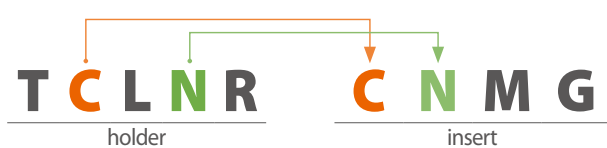

* Related to Insert Designation to check compatibility

(10 - Optional Clamp)

Symbol	Optional Clamp
C	Included

Insert ISO Code System













*Metric : According to ISO 1832

page 12

page 10

1	2	3	4	5	6	7	8	9
C	N	M	G	12	04	08	-UG	YG3020
Shape	Clearance	Tolerance	Clamping & Chipbreaker	Insert Size	Insert Thickness	Corner Radius	Chipbreaker Geometry	Grade

1 - Shape

Symbol	Shape	
H	Hexagonal	
O	Octagonal	
P	Pentagonal	
S	Square	
T	Triangular	
C	Rhombic 80°	
D	Rhombic 55°	
V	Rhombic 35°	
W	Trigon	
L	Rectangular	
K	Parallelogram 55°	
R	Round	

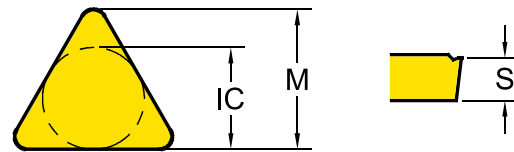







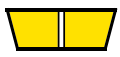

3 - Tolerance Class



Symbol	Inner Circle IC (mm)	Nose Height M (mm)	Thickness S (mm)
C	± 0.025	± 0.013	± 0.025
E	± 0.025	± 0.025	± 0.025
G	± 0.025	± 0.025	± 0.13
H	± 0.013	± 0.013	± 0.025
K*	± 0.05~0.15*	± 0.013	± 0.025
M*	± 0.05~0.15*	± 0.08~0.2*	± 0.13
U*	± 0.08~0.25*	± 0.13~0.38*	± 0.13

*Tolerance is different by insert IC size. Please see ISO 1832

4 - Clamping & Chipbreaker

Symbol	Clamping	Chipbreaker	Figure
N	No clamping hole	X	
R		One Face	
A	Cylindrical Clamping hole	X	
M		One Face	
G		Both Faces	
W	Screw Hole	X	
T		One Face	
U		Both Faces	
X		Special	

2 - Relief Angle (AN)

Symbol	Relief Angle (AN)	
N	No Relief Angle	
B	Relief 5°	
C	Relief 7°	
P	Relief 11°	
D	Relief 15°	
E	Relief 20°	
F	Relief 25°	
O	Special	

Insert ISO Code System

*Inch

page 12

page 10

1	2	3	4	5	6	7	8	9
C	N	M	G	4	3	2	-UG	YG3020
Shape	Clearance	Tolerance	Clamping & Chipbreaker	Insert Size	Insert Thickness	Corner Radius	Chipbreaker Geometry	Grade

5 - Insert Size

Metric							Inner Circle IC (mm)	Inch
S	T	C	D	V	W	R		
06	11	06	07	11			6.35	2
07							7.94	2.5
09	16	09	11	16	06	09 (00)	9.525	3
12	22	12	15	22	08	12 (00)	12.7	4
15		16					15.875	5
19		19					19.05	6
25		25					25.4	8
						06 (M0)	6	
						08 (M0)	8	
						10 (M0)	10	
						12 (M0)	12	
						16 (M0)	16	

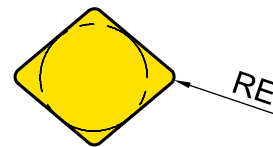
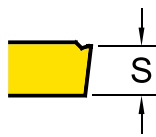

6 - Insert Thickness (S)

Metric	Thickness - S (mm)	Inch
T1	1.98	1.2
02	2.38	1.5
03	3.18	2
T3	3.97	2.5
04	4.76	3
05	5.56	3.5
06	6.35	4
07	7.94	5
09	9.525	6

7 - Corner Radius (RE)

Metric	Corner Radius - RE (mm)	Inch
01	0.1	0
02	0.2	0.5
04	0.4	1
08	0.8	2
12	1.2	3
16	1.6	4
20	2.0	5
24	2.4	6

TURNING





PARTING & GROOVING

MILLING

DRILLING

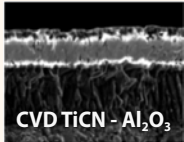
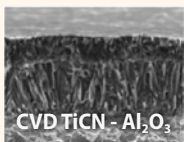
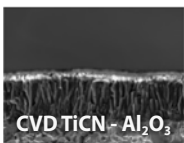
TECHNICAL INFORMATION

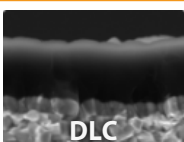
Turning Grades	P Steel				M Stainless steel			K Cast iron			N Non-ferrous		S Superalloys	
	P10	P20	P30	P40	M10	M20	M30	K10	K20	K30	N10	N20	S10	S20
CVD	YG1001	1001							1001					
	YG3010		3010							3010				
	YG3020			3020										
	YG3030				3030									
PVD	YG801	801												
	YG211					211							211	
	YG213						213							213
	YG214							214						214
DLC	YG100										100			
-	YG10										10			

YG1001 P01 - P10 K10 - K25	 <p>CVD TiCN - Al₂O₃</p>	First choice for stable machining of Cast iron <ul style="list-style-type: none"> • Substrate especially designed for high wear resistance • Thick Al₂O₃ layer ensures good wear resistance at high cutting speeds including dry machining
YG3010 P05 - P20 K15 - K35	 <p>CVD TiCN - Al₂O₃</p>	First choice for Finishing Steels, and Ductile Cast iron <ul style="list-style-type: none"> • Finishing and light machining of steel under in stable condition • New Al₂O₃ coating technology and excellent surface smoothness increase wear resistance and chipping resistance
YG3020 P15 - P30	 <p>CVD TiCN - Al₂O₃</p>	First Choice grade for general Steel application <ul style="list-style-type: none"> • Substrate especially designed for good toughness • Excellent surface smoothness increases wear resistance and reliability
YG3030 P20 - P35 M10 - M30	 <p>CVD TiCN - Al₂O₃</p>	Interrupted cut of Steel and Stainless steel <ul style="list-style-type: none"> • Heavy interrupted cut for Steel • High cutting speed for Stainless steel
YG801 P10 - P30	 <p>PVD - TiAlN</p>	for Carbon Steel with Low cutting speed <ul style="list-style-type: none"> • Recommended for mild steel and boring application • Substrate and special PVD coating for excellent wear resistance
YG100 N05 - N25	 <p>DLC</p>	First Choice grade for aluminum with DLC coating <ul style="list-style-type: none"> • Submicron carbide for high wear resistance • DLC coating minimizes Built Up Edge tendency. • Improve tool life in sticky non-ferrous alloy
YG10 N05 - N25	 <p>Uncoated</p>	Uncoated Grade for General Aluminum <ul style="list-style-type: none"> • Substrate consisted of submicron carbide for high wear resistance • Shining surface to prevent built up edge

Product Overview

Turning Grade Map

<p>YG211 M05 - M25 S05 - S20</p>		<p>High wear resistance grade for Super alloys and Stainless steel</p> <ul style="list-style-type: none"> • Finishing Stainless steel • Finishing Super alloys and Titanium
<p>YG213 M20 - M35 S15 - S25</p>		<p>First Choice Grade on low cutting speed of Stainless steel</p> <ul style="list-style-type: none"> • First choice on Stainless steel for Low cutting speed • For Medium to low cutting speed
<p>YG214 M30 - M40 S25 - S30</p>		<p>Heavy Interrupted cut for Stainless steel</p> <ul style="list-style-type: none"> • For Heavy Interrupted cut on Stainless steel • Minimize risk of Mechanical fracture or Chipping

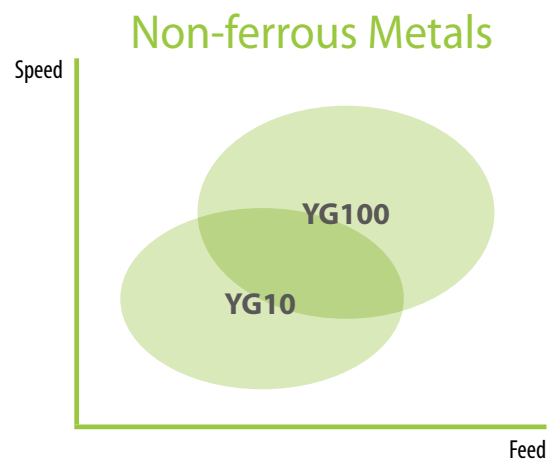
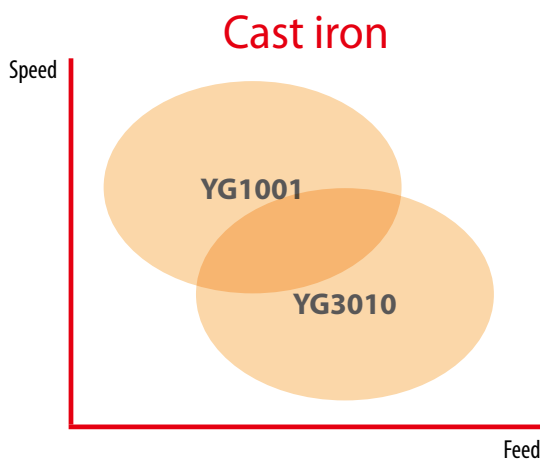
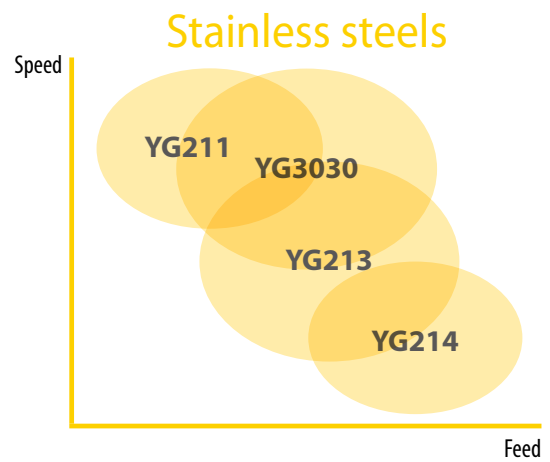
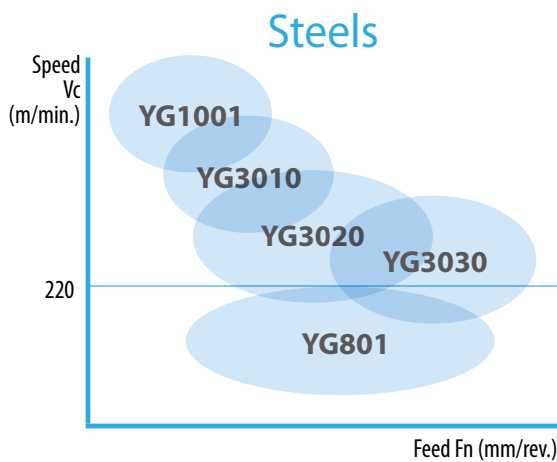

Product Overview

Turning Chipbreakers - Negative

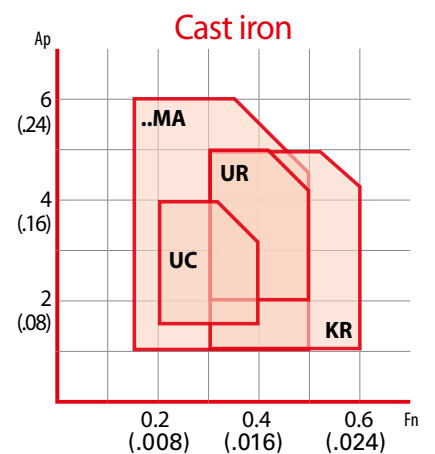
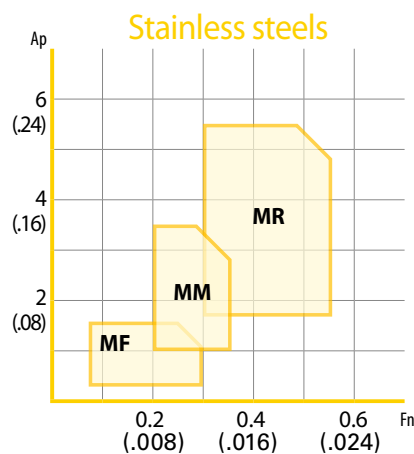
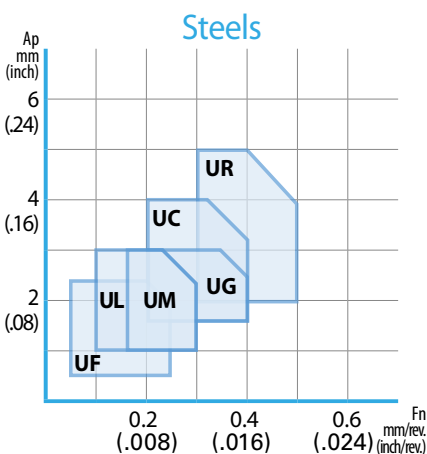
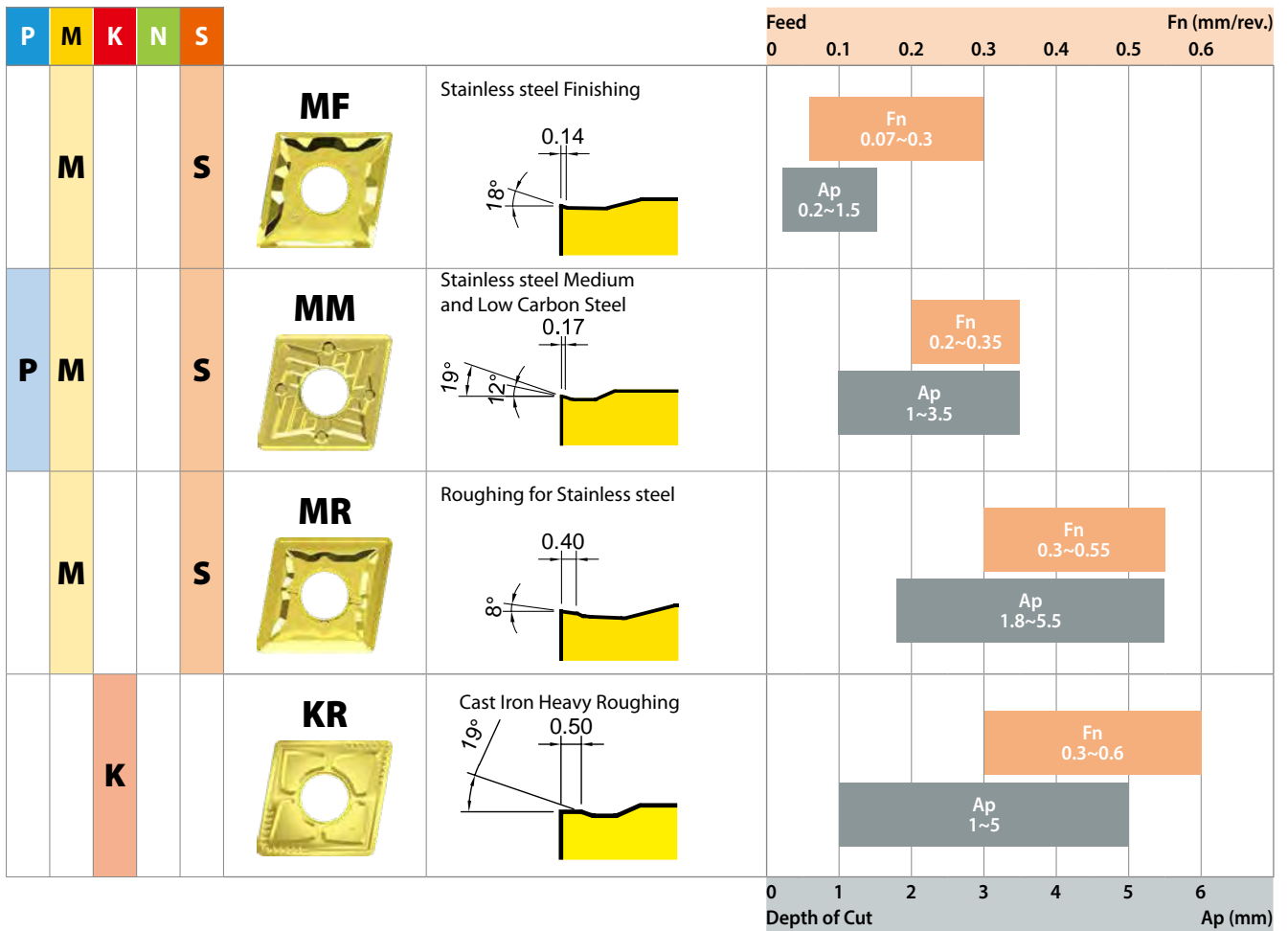

Turning Chipbreakers - Positive

TURNING

PARTING & GROOVING

MILLING

DRILLING

TECHNICAL INFORMATION

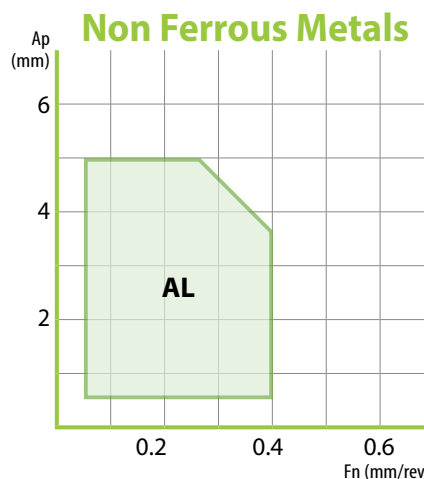
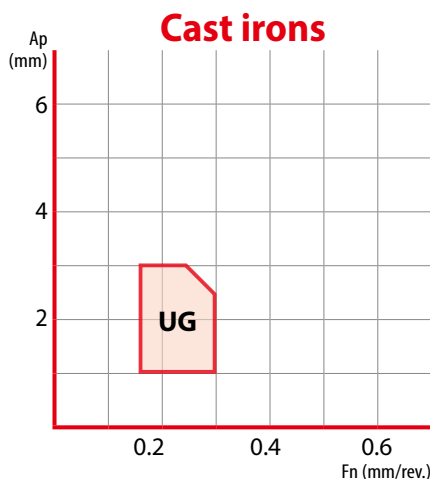
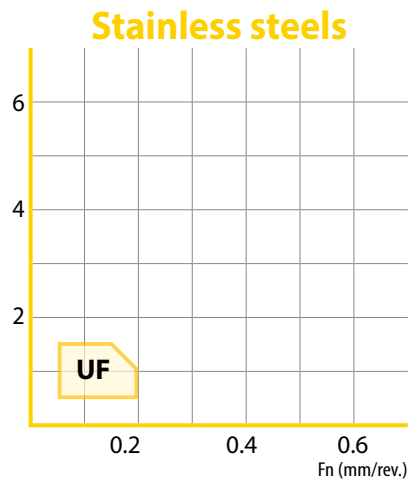
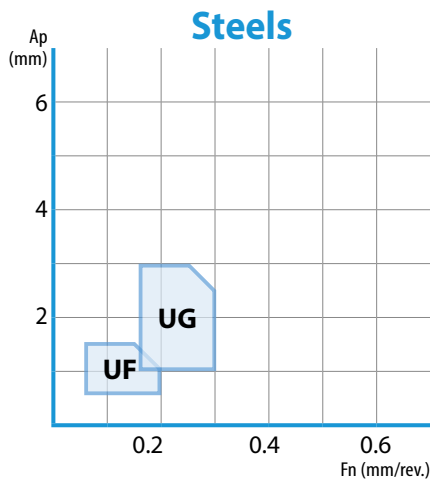
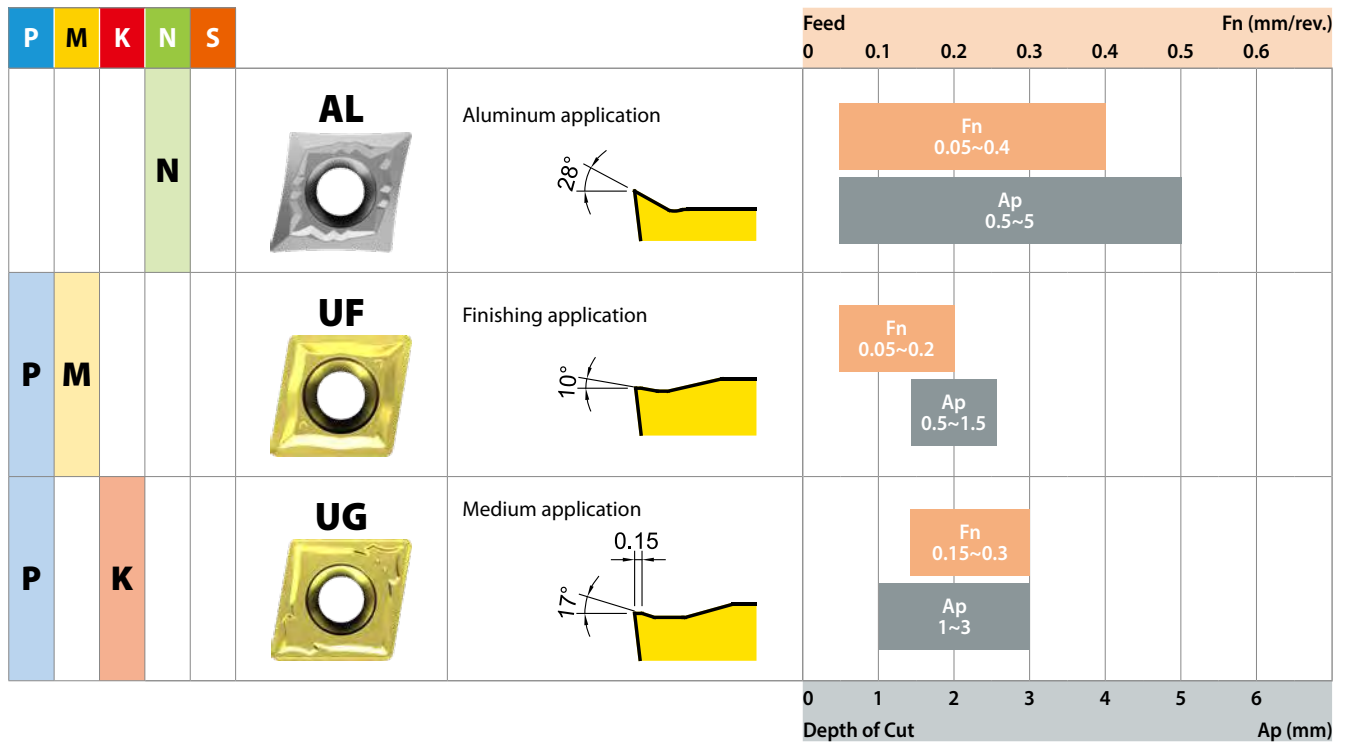

Application Guide

Steel Guide

Grade Recommendation based on Workpiece Material Condition

	<p>Pre Machined Condition No Outer Skin Uniform hardness on material Has stable machining condition</p>		TURNING	
	<p>Welded Condition Soft / NoOuter Skin Weld Bead Could be of Different Hardness than Actual Part Stock on Part could even except weld Seam during Machining causing shock loads</p>			PARTING & GROOVING
	<p>Cast Condition Hard Outer Skin Could have Sand Inclusion,- if Green Sand Cast Component could have uneven Stock during machining</p>			MILLING
	<p>Hot Rolled Condition Soft / NoOuter Skin Usually heat treated before machine to reduce Hardness Component could have uneven Stock During Machining</p>			DRILLING
	<p>Forged Condition Soft Outer Skin Usually heat treated before machine to reduce Hardness Component could have uneven Stock during machining</p>			TECHNICAL INFORMATION

Chipbreaker, Feed Rate and Depth of Cut

	Sharp Edge	General	Strong Edge

Application Guide Steel Guide

TURNING

PARTING & GROOVING

MILLING

DRILLING

TECHNICAL INFORMATION

P Non Alloy Steel, About 0.15% C (Low Carbon Steel)										
VDI	JIS	DIN	Mat'l No.	AISI/ASTM	SS	AFNOR	UNI	UNE	BS	GOST
1	S15C	CK15	1.0401	1015	1350	XC18	C15	F.1110	080M15	15

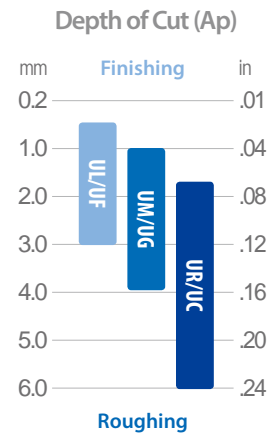
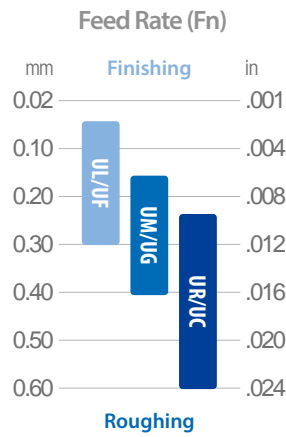
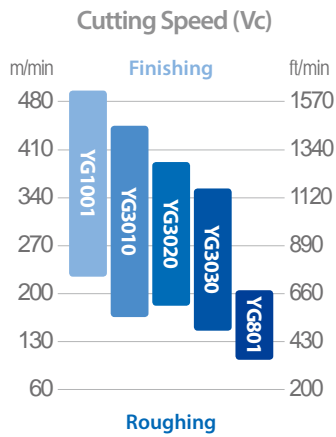

First Choice Grade and Value
YG3010 - Vc 330m/min (1,080ft/min)
YG801 - Vc 170m/min (560ft/min)

P Non Alloy Steel, About 0.45% C (Medium Carbon Steel)										
VDI	JIS	DIN	Mat'l No.	AISI/ASTM	SS	AFNOR	UNI	UNE	BS	GOST
2-3	S45C	C45	1.0503	1045	1672	XC42H1TS	C45	F.1140	060A47	45

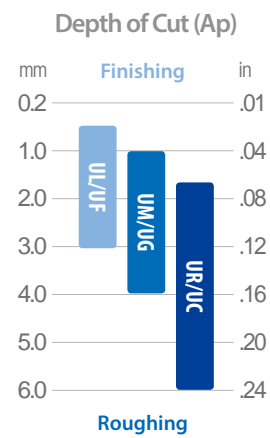
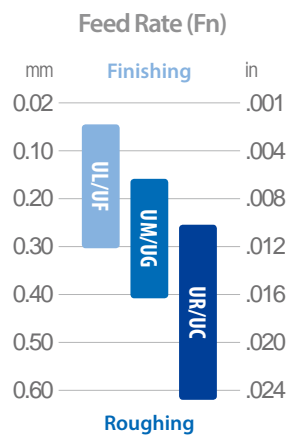
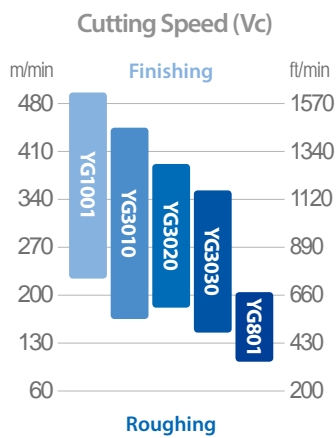

First Choice Grade and Value
YG3010 - Vc 330m/min (1,080ft/min)
YG801 - Vc 170m/min (560ft/min)

Application Guide

Steel Guide

P		Low-alloyed Steel								
VDI	JIS	DIN	Mat'l No.	AISI/ASTM	SS	AFNOR	UNI	UNE	BS	GOST
6-9	SCM440	42CrMo4	1.7225	4140	2244	42 CD 4	42CrMo4	F.1252	708M40	38HM

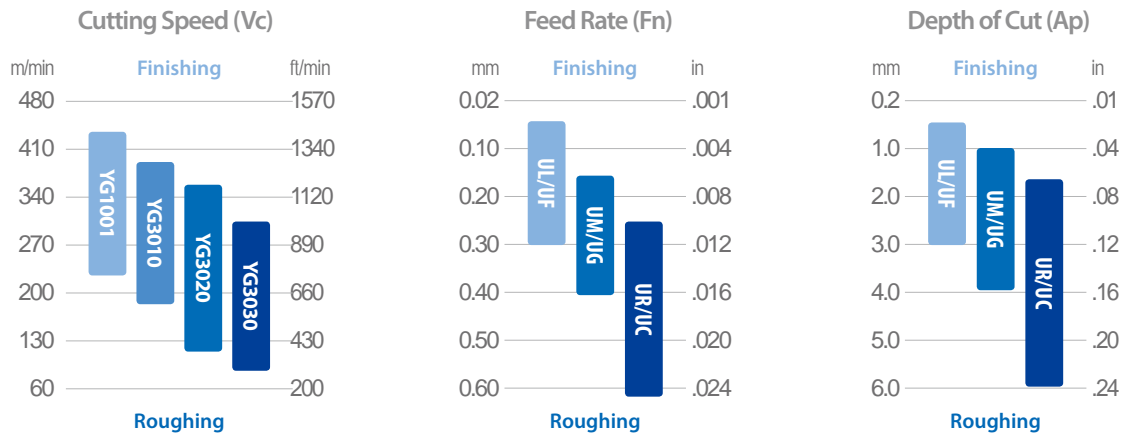

First Choice Grade and Value
 YG3020 - Vc 240m/min (790ft/min)

P		High Alloyed Steel, and Tool Steel								
VDI	JIS	DIN	Mat'l No.	AISI/ASTM	SS	AFNOR	UNI	UNE	BS	GOST
10-11	SKD11	X155CrVMo121	1.2379	D2	2310	Z160CDV12	X165CrMoW12KU	F.5318	BD2	KH12MF

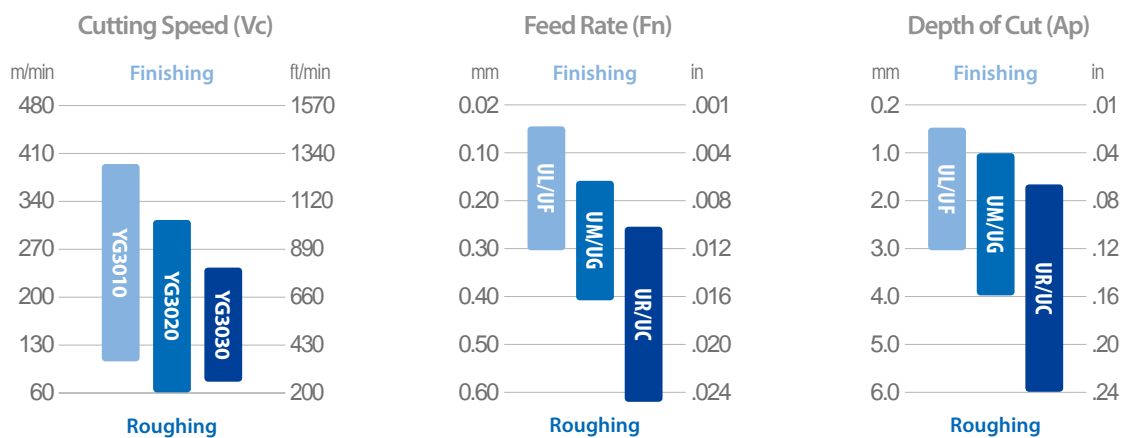

First Choice Grade and Value
 YG3020 - Vc 230m/min (750ft/min)

Application Guide

Stainless steel Guide

TURNING

PARTING & GROOVING

MILLING

DRILLING

TECHNICAL INFORMATION

M	Ferritic / Martensitic Stainless									
VDI	JIS	DIN	Mat'l No.	AISI/ASTM	SS	AFNOR	UNI	UNE	BS	GOST
12-13	SUS430	X6Cr17	1.4016	430	2320	Z8C17	Z8C17	F.3113	430S15	12C17

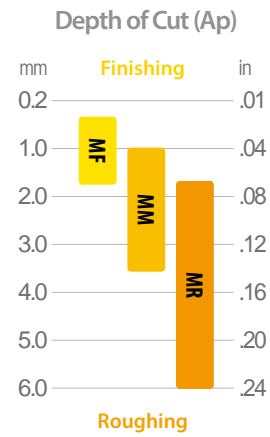
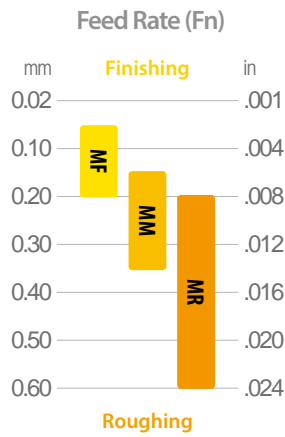
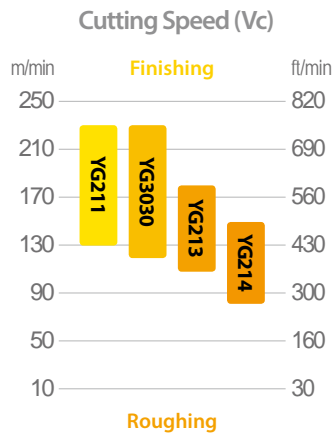

First Choice Grade and Value

Ferritic Stainless steel

YG3030 - Vc 200m/min (660ft/min)
 YG213 - Vc 160m/min (520ft/min)

Martensitic

YG3030 - Vc 160m/min (520ft/min)
 YG213 - Vc 130m/min (430ft/min)

M	Austenitic Stainless steel									
VDI	JIS	DIN	Mat'l No.	AISI/ASTM	SS	AFNOR	UNI	UNE	BS	GOST
14	SUS304	X5CrNi18 9	1.4350	304	2332	Z6CN18 09	X5CrNi18 10	F.3551	304S15	03KH18N11

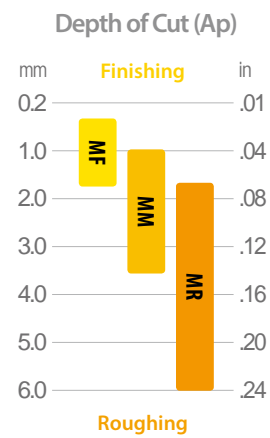
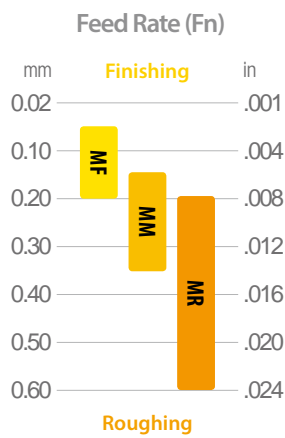
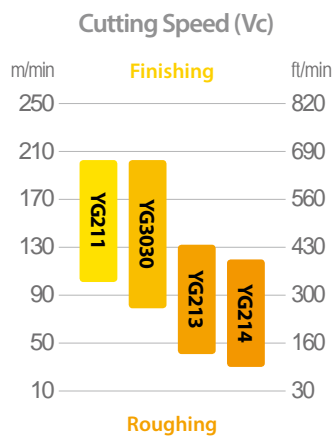

First Choice Grade and Value

YG3030 - Vc 180m/min (590ft/min)
 YG213 - Vc 140m/min (460ft/min)

Application Guide

Cast iron Guide

K		Grey cast iron								
VDI	JIS	DIN	Mat'l No.	AISI/ASTM	SS	AFNOR	UNI	UNE	BS	GOST
15-16	FC250	GG25	0.6025	A48 40 B	0125	Ft 25 D	G25	FG25	Grade 260	Sc 25

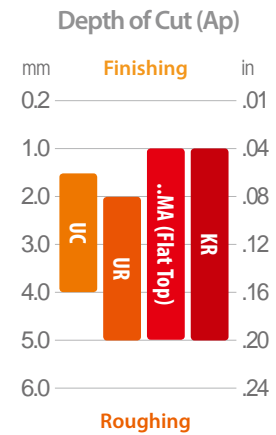
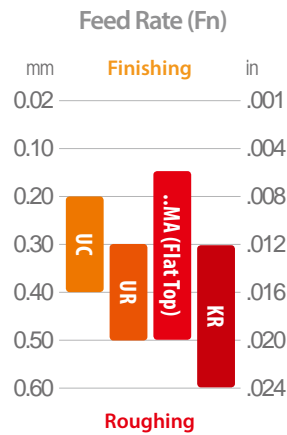
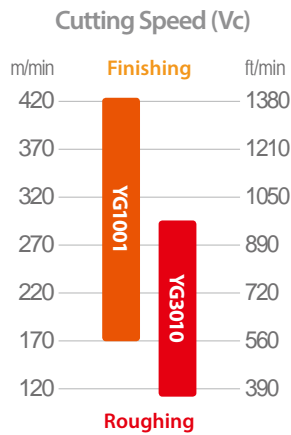

First Choice Grade and Value
 YG1001 - Vc 350m/min (1,150ft/min)

K		Nodular cast iron								
VDI	JIS	DIN	Mat'l No.	AISI/ASTM	SS	AFNOR	UNI	UNE	BS	GOST
17-18	FCD500	GGG50	0.7050	80-55-06	0.7050	FGS 500-7	GS 500-7	FGE50-7	SNG 500-7	Vc 50-2

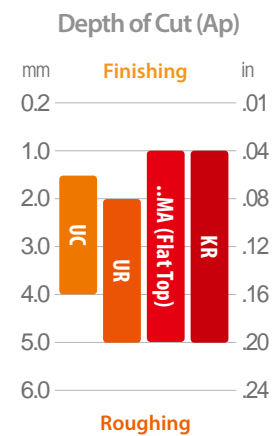
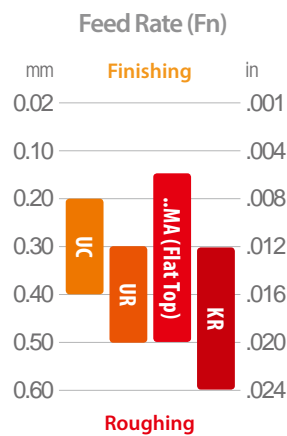
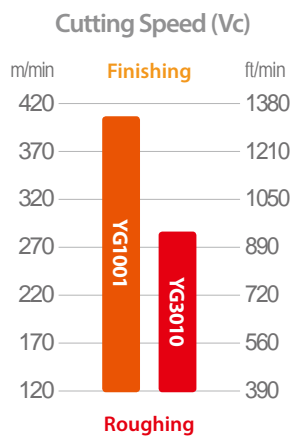

First Choice Grade and Value
 YG3010 - Vc 220m/min (720ft/min)

Formulas

Cutting Speed (Vc)

Metric

$$Vc = D \times RPM \times 0.0031 \text{ (m/min)}$$

Inch

$$Vc = D \times RPM \times .262 \text{ (ft/min)}$$

Metric Vc to Inch Vc

$$\text{Inch Vc} = \text{Metric Vc} \times 3.28 \text{ (ft/min)}$$

Inch Vc to Metric Vc

$$\text{Metric Vc} = \text{Inch Vc} \times .305 \text{ (m/min)}$$

Spindle Speed (RPM)

Metric

$$RPM = Vc \times 318.3 \div D \text{ (rev/min)}$$

Inch

$$RPM = Vc \times 3.82 \div D \text{ (rev/min)}$$

Feed Rate (Vf = Table Feed)

$$Vf = Fn \times RPM \text{ (mm/min or in/min)}$$

Feed per Revolution (Fn)

$$Fn = Vf \div RPM \text{ (mm/min or in/min)}$$

Metal Removal Rate (Q)

Metric

$$Q = Vc \times Fn \times Ap \text{ (cm}^3\text{/min)}$$

Inch

$$Q = Vc \times Fn \times Ap \times 12 \text{ (in}^3\text{/min)}$$

Cutting Time

$$T = L \div Vf \text{ (min)}$$

Terms

RPM (n)	Spindle Speed (Revolution per minute)
Vc	Cutting Speed
D	Work Diameter
Vf	Feed Rate (Table Feed)
Fn	Feed per Revolution
Ap	Depth of Cut
Q	Metal Removal Rate
L	Length of cut
T	Cutting Time (min)

Application Guide

Surface Roughness Guide

Trouble Shooting

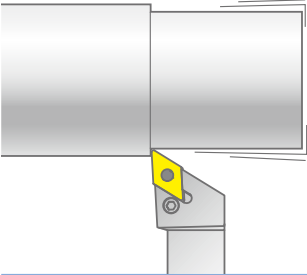
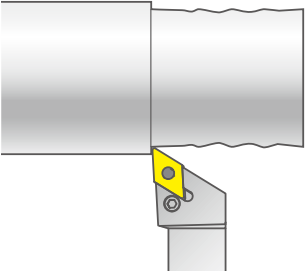
Pattern	Reasons	Solutions
<p>Vibration</p> 	<ul style="list-style-type: none"> - High radial or tangential force - Unstable condition 	<ul style="list-style-type: none"> - Lower depth of cut (ap) - Use sharper chipbreaker - Check stability, and position of tool and workpiece - Reduce the overhang (bigger and shorter tool)
<p>Bad Surface</p> 	<ul style="list-style-type: none"> - Work material is damaged by chips - Feed is too high for corner radius 	<ul style="list-style-type: none"> - Different chipbreaker - Lower depth of cut (ap) - Lower feed - Bigger corner radius

Theoretical Surface Roughness

Ra / Rz μm (μinch)	Insert Corner Radius Code ISO (ANSI)					
	02 (0)	04 (1)	08 (2)	12 (3)	16 (4)	24 (6)
	Feed Rate mm/rev (inch/rev)					
0.4 / 1.6 (16 / 64)	0.05 (.002)	0.07 (.003)	0.1 (.004)	0.12 (.005)	0.14 (.006)	0.18 (.007)
1.6 / 6.3 (64 / 256)	0.1 (.004)	0.14 (.006)	0.2 (.008)	0.25 (.010)	0.28 (.011)	0.35 (.014)
3.2 / 12.5 (128 / 512)	0.14 (.006)	0.2 (.008)	0.28 (.011)	0.35 (.014)	0.4 (.016)	0.49 (.019)
6.3 / 25 (250 / 1000)	-	0.28 (.011)	0.4 (.016)	0.49 (.019)	0.57 (.022)	0.69 (.027)
8 / 32 (320 / 1280)	-	-	0.45 (.018)	0.55 (.022)	0.64 (.025)	0.78 (.031)

Application Guide

Trouble Shooting

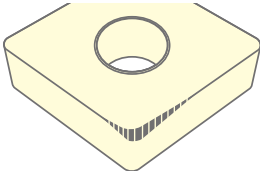
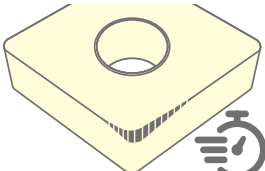
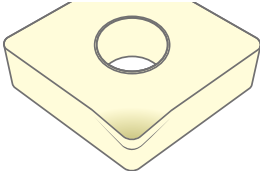
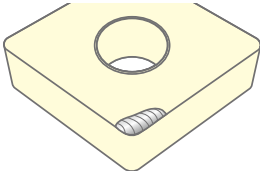
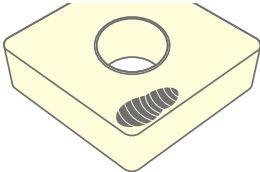
Pattern	Reasons	Solutions
<p>General Flank Wear</p>  <p>Flank face near by corner is abraded</p>	<ul style="list-style-type: none"> - The most ideal wear - Consistent and predictable - General wear behavior when machining condition is normal 	
<p>Rapid Flank Wear</p>  <p>Looks same as general flank wear, but happens quickly</p>	<p>Grade</p> <ul style="list-style-type: none"> - Not enough wear resistance - Too tough grade <p>Heat</p> <ul style="list-style-type: none"> - Cutting speed is too high - Not enough coolant 	<ul style="list-style-type: none"> - More wear resistant grade - Reduce the cutting speed (Vc, SFM, RPM or SFPM) - Optimize coolant - Increase Feed (Fn) if feed is low
<p>Plastic Deformation</p>  <p>Deformed Edge</p>	<ul style="list-style-type: none"> - Excess thermal load - Excess mechanical load 	<ul style="list-style-type: none"> - Reduce cutting temperature - More wear resistant grade - Reduce the cutting speed (Vc, SFM, RPM or SFPM) - Lower feed (Fn) - Lower depth of cut (ap) - Optimize coolant
<p>Built up Edge</p>  <p>Workpiece material is welded on the cutting edge</p>	<ul style="list-style-type: none"> - Sticky materials (low carbon steel, Stainless steel, non-ferrous metal, heat resistant super alloys) - Too low cutting speed 	<ul style="list-style-type: none"> - Increase cutting speed - Lower feed rate - Sharper chipbreaker & geometry - Use high pressure coolant - Use PVD grade - Use Positive Insert
<p>Cratering</p> 	<p>Heat</p> <ul style="list-style-type: none"> - Cutting speed is too high - Too tough grade 	<ul style="list-style-type: none"> - Reduce cutting temperature - Lower cutting speed (Vc, SFM, RPM or SFPM) - Adjust Feed (Fn) - Harder grade

Application Guide Trouble Shooting

TURNING

PARTING & GROOVING

MILLING

DRILLING

TECHNICAL INFORMATION

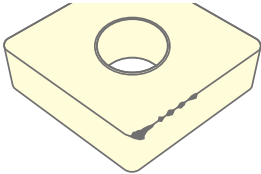
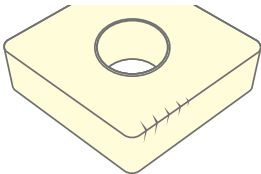
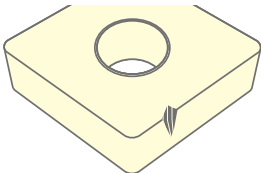
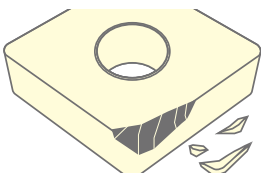
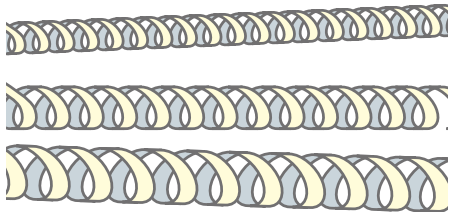
Pattern	Reasons	Solutions
Chipping 	<ul style="list-style-type: none"> - Unstable machining condition (Vibration) - Grade is too hard / brittle - Grade is too sharp 	<ul style="list-style-type: none"> - Focus on stabilizing cutting condition - Reduce overhang (shorter and bigger tool) - Tougher grade - Tougher chipbreaker
Thermal Crack 	<ul style="list-style-type: none"> - Thermal stress due to rapid change of temperature 	<ul style="list-style-type: none"> - Tougher grade - Lower cutting speed (Vc, SFM, RPM or SFPM) - Lower feed (Fn) - Sharper chipbreaker - Change coolant / dry cut
Notching 	<ul style="list-style-type: none"> - Improved edge strength work piece has hardened skin 	<ul style="list-style-type: none"> - More wear resistant grade - Reduce the cutting speed (Vc, SFM, RPM or SFPM) - Adjust Feed (Fn) - Lower depth of cut (ap) - Optimize coolant - Go for tougher chipbreaker
Breakage (Mechanical Fracture) 	<ul style="list-style-type: none"> - Mechanical load is too heavy (feed or depth is too high) - Heavy interrupted cut - Grade is too hard for work material - Unstable machining(vibration) - Cutting speed is too low - Impurities in work material 	<ul style="list-style-type: none"> - Lower feed (Fn) or depth of cut (ap) - Tougher grade - Reduce overhang and check stability of tool and work material - Higher cutting speed (Vc, SFM, RPM or SFPM)
Long Chip 	<ul style="list-style-type: none"> - Feed is too low for chipbreaker - Depth of cut is too shallow for corner radius - Chip area (Fn x Ap) too low 	<ul style="list-style-type: none"> - Higher feed - Sharper chipbreaker - Higher depth of cut - Select a smaller corner radius

Turning - Holder - External

External Holders Overview









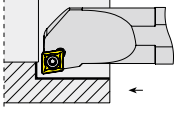
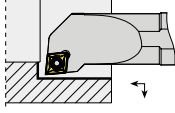
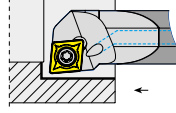

Series	Turning Holder				
 <p>CCGT CCMT</p>	 <p>SCACR/L Screw</p>	 <p>SCLCR/L Screw</p>			
p. 78	p. 29	p. 29			
 <p>CNMA CNMG</p>	 <p>PCBNR/L Lever</p>	 <p>PCLNR/L Lever (+Clamp)</p>	 <p>TCLNR/L Hole Clamp</p>		
p. 60	p. 30	p. 30	p. 30		
 <p>DCGT DCMT</p>	 <p>SDNCN Screw</p>	 <p>SDJCR/L Screw</p>			
p. 79	p. 31	p. 31			
 <p>DNMA DNMG</p>	 <p>TDHNR/L Hole Clamp</p>	 <p>PDNNN Lever (+Clamp)</p>	 <p>TDNNN Hole Clamp</p>	 <p>TDJNR/L Hole Clamp</p>	 <p>PDJNR/L Lever (+Clamp)</p>
p. 63	p. 32	p. 32	p. 32	p. 32	p. 32
 <p>KNUX</p>	 <p>CKJNR/L Top Clamp</p>				
p. 66	p. 33				
 <p>RCMT</p>	 <p>SRGCR/L Screw</p>	 <p>SRDCN Screw</p>			
p. 80	p. 34	p. 34			
 <p>SCMT</p>	 <p>SSDCN Screw</p>	 <p>SSSCR/L Screw</p>			
p. 81	p. 35	p. 35			

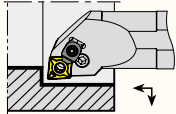
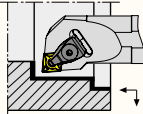
External Holders Overview

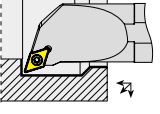
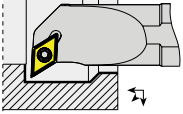
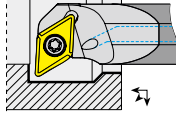

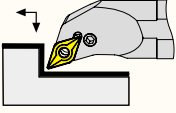
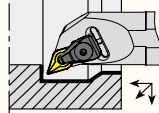
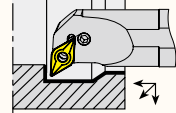
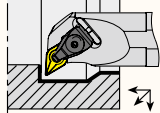

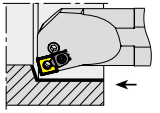

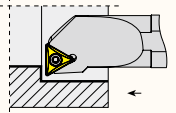
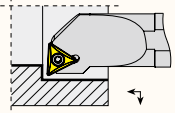

Series	Turning Holder							
 <p>SNMA SNMG</p>	 PSDNN Lever (+Clamp)	 TSDNN Hole Clamp	 PSSNR/L Lever (+Clamp)	 TSSNR/L Hole Clamp	 PSBNR/L Lever (+Clamp)	 TSKNR/L Hole Clamp	 PSKNR/L Lever (+Clamp)	
p. 67	p. 36	p. 36	p. 36	p. 36	p. 36	p. 36	p. 36	p. 36
 <p>TCGT TCMT</p>	 STFCR/L Screw	 STGCR/L Screw	 STJCR/L Screw	 STUCR/L Screw				
p. 82	p. 37	p. 37	p. 37	p. 37				
 <p>TNMA TNMG TNUX</p>	 PTTNR/L Lever (+Clamp)	 PTFNR/L Lever (+Clamp)	 PTGNR/L Lever (+Clamp)	 TTGNR/L Hole Clamp	 MTJNR/L Pin + Clamp	 PTJNR/L Lever (+Clamp)	 TTJNR/L Hole Clamp	
p. 69	p. 38	p. 38	p. 38	p. 38	p. 39	p. 39	p. 39	
 <p>VBMT</p>	 SVHBR/L Screw	 SVVBN Screw	 SVJBR/L Screw					
p. 83	p. 40	p. 40	p. 40					
 <p>VCGT VCMT</p>	 SVHCR/L Screw	 SVVCN Screw	 SVJCR/L Screw					
p. 84	p. 41	p. 41	p. 41					
 <p>VNMA VNMG</p>	 TVVNN Hole Clamp	 TVJNR/L Hole Clamp						
p. 73	p. 42	p. 42						
 <p>WNMA WNMG</p>	 MWLNR/L Pin + Clamp	 PWLNR/L Lever (+Clamp)	 TWLNR/L Hole Clamp					
p. 75	p. 43	p. 43	p. 43					

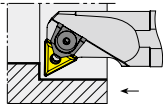
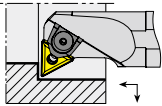
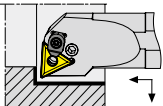
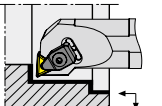
Turning - Holder - Internal

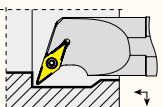
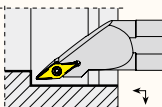
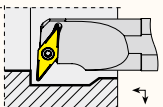
Internal Holders Overview

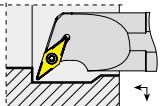
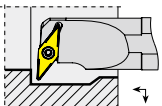
Series		Turning Holder			
	CCGT CCMT	 ..SCFCR/L Screw p. 44	 ..SCLCR/L Screw p. 45	 E..SCLCR/L Screw p. 45	
	p. 78				
	CNMA CNMG	 ..PCLNR/L Lever (+Clamp) p. 46	 ..TCLNR/L Hole Clamp p. 46		
	p. 60				
	DCGT DCMT	 ..SDQCR/L Screw p. 47	 ..SDUCR/L Screw p. 48	 E..SDUCR/L Screw p. 48	
	p. 79				
	DNMA DNMG	 ..PDQNR/L Lever (+Clamp) p. 49	 ..TDQNR/L Hole Clamp p. 49	 ..PDUNR/L Lever (+Clamp) p. 49	 ..TDUNR/L Hole Clamp p. 49
	p. 63				
	SNMA SNMG	 ..PSKNR/L Lever (+Clamp) p. 50			
	p. 67				
	TCGT TCMT	 ..STFCR/L Screw p. 51	 ..STUCR/L Screw p. 51		
	p. 82				

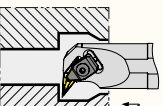
Turning - Holder - Internal Internal Holders Overview

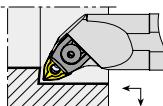
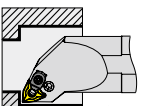
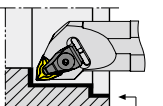
Series	Turning Holder			
 <p>TNMA TNMG TNUX</p>	 <p>..-MTFNR/L Pin + Clamp</p>	 <p>..-MTUNR/L Pin + Clamp</p>	 <p>..-PTUNR/L Lever (+Clamp)</p>	 <p>..-TTUNR/L Hole Clamp</p>
p. 69	p. 52	p. 52	p. 53	p. 53
 <p>VBMT</p>	 <p>..-SVQBR/L Screw</p>	 <p>..-SVJBR/L Screw</p>	 <p>..-SVUBR/L Screw</p>	
p. 83	p. 54	p. 54	p. 54	
 <p>VCGT VCMT</p>	 <p>..-SVQCR/L Screw</p>	 <p>..-SVUCR/L Screw</p>		
p. 84	p. 55	p. 55		
 <p>VNMA VNMG</p>	 <p>..-TVUNR/L Hole Clamp</p>			
p. 73	p. 56			
 <p>WNMA WNMG</p>	 <p>..-MWLNR/L Pin + Clamp</p>	 <p>..-PWLNR/L Lever (+Clamp)</p>	 <p>..-TWLNR/L Hole Clamp</p>	
p. 75	p. 57	p. 57	p. 58	

Turning - Holder - External

External Holders for CC** Insert

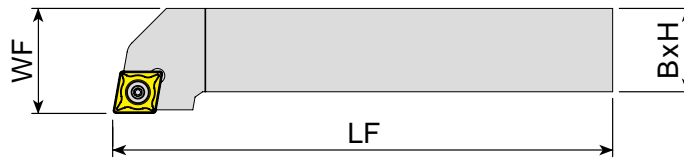

: p. 78 unit:mm

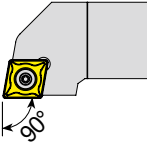
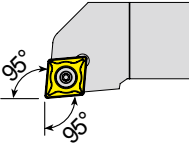
Series	Designation	EDP 2700..		H	B	WF	LF	Insert
		R	L					
 SCACR/L (Screw Type 90°)	SCACR/L 0808E 06	0675	0676	08	08	10	70	CC0602
 SCLCR/L (Screw Type 95°)	SCLCR/L 0808E 06	0689	0690	08	08	10	70	CC0602
	SCLCR/L 1010E 06	0691	-	10	10	12	70	
	SCLCR/L 1010E 09	0692	0693	10	10	12	70	CC09T3
	SCLCR/L 1212F 09	0089	0090	12	12	16	80	
	SCLCR/L 1616H 09	0091	0092	16	16	20	100	
	SCLCR/L 2020K 09	0093	0094	20	20	25	125	
	SCLCR/L 2525M 09	0694	0695	25	25	32	150	CC1204
	SCLCR/L 1616H 12	0696	-	16	16	20	100	
	SCLCR/L 2020K 12	0095	0096	20	20	25	125	
	SCLCR/L 2525M 12	0097	0098	25	25	32	150	

Series	Size	Screw	Shim	Shim Screw	Torx Key
SCACR/L	..06	Y4008-M2.5x6	-	-	Y80-T08
	..06	Y4008-M2.5x6	-	-	Y80-T08
	..1010..09	Y4015-M3x9	-	-	Y80-T15
SCLCR/L	..1212..09	Y4015-M3.5x11	-	-	Y80-T15
	..1616~2525..09	Y4015-M3.5x14	YAACN-2-0001	YAAV-06-M3.5x11	Y80-T15
	..1616..12	Y1020-M5x11	-	-	Y80-T20
	..2020~2525..12	Y1020-M4.5x16	YAACN-2-0003	YAAV-07-M4.5x13	Y80-T20

External Holders for CN** Insert

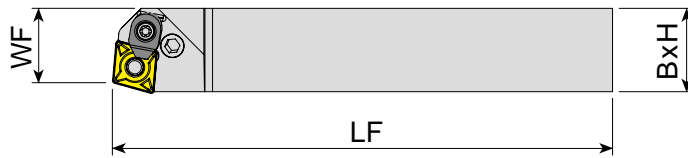

* 'C' Letter at Last : Optional Clamp Included

: p. 60 unit:mm

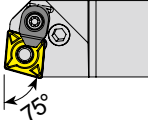
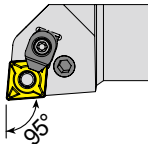
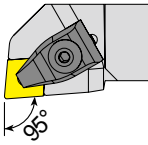
Series	Designation	EDP 2700.. R	L	H	B	WF	LF	Insert
 PCBNR/L (Lever Type 75°)	PCBNR/L 2525M 16C	0444	0445	25	25	22	150	CN1606
	PCBNR/L 3232P 16C	0446	0447	32	32	27	170	
	PCBNR/L 3232P 19C	0448	0449	32	32	37	170	CN1906
	PCBNR/L 4040S 19C	0450	0451	40	40	37	250	
 PCLNR/L (Lever Type 95°)	PCLNR/L 1616H 12	0464	0465	16	16	20	100	CN1204
	PCLNR/L 2020K 12C	0466	0467	20	20	25	125	
	PCLNR/L 2525M 12C	0468	0469	25	25	32	150	
	PCLNR/L 3232P 12C	0470	0471	32	32	40	170	
	CN1606	PCLNR/L 2525M 16C	0472	0473	25	25	32	150
		PCLNR/L 3232P 16C	0474	0475	32	32	40	170
		PCLNR/L 2525M 19C	0476	0477	25	25	32	150
		PCLNR/L 3232P 19C	0478	0479	32	32	40	170
		PCLNR/L 4040S 19C	0480	0481	40	40	50	250
 TCLNR/L (Hole Clamp Type 95°)	TCLNR/L 2020K 12	0482	0483	20	20	25	125	CN1204
	TCLNR/L 2525M 12	0484	0485	25	25	32	150	
	TCLNR/L 3232P 12	0486	0487	32	32	40	170	CN1606
	TCLNR/L 2525M 16	0492	0493	25	25	32	150	
	TCLNR/L 3232P 16	0494	-	32	32	40	170	

Series	Size	Lever	Lever Screw	Clamp	Clamp Screw	Upper Ring	Lower Ring	Shim	Shim Screw	Shim Pin	Allen Key
PCBNR/L	..16C	YAPL-04	YALV-04-M8x22	YACK-09	YAAV-05-M6x15	-	-	YAACN-3-0002	-	YAAY-03	YAAL-03-3
	..19C	YAPL-05	YALV-05-M10x27	YACK-09	YAAV-05-M6x15	-	-	YAACN-3-0003	-	YAAY-04	YAAL-05-4
PCLNR/L	..12	YAPL-02	YALV-03-M8x19	-	-	-	-	YAACN-3-0001	-	YAAY-02	YAAL-03-3
	..2020~3232..12C	YAPL-02	YALV-03-M8x19	YACK-05	Y4015-M4x11	-	-	YAACN-3-0001	-	YAAY-02	YAAL-03-3
	..16C	YAPL-04	YALV-04-M8x22	YACK-09	YAAV-05-M6x15	-	-	YAACN-3-0002	-	YAAY-03	YAAL-03-3
	..19C	YAPL-05	YALV-05-M10x27	YACK-09	YAAV-05-M6x15	-	-	YAACN-3-0003	-	YAAY-04	YAAL-05-4
TCLNR/L	..12	-	-	YATK-02	YAKV-30-M6x22	YABPL-01	YAS-01	YAACN-3-0001	YAAV-02-M5x12	-	YAAL-03-3
	..16	-	-	YATK-04	YAKV-19-M7x25	YABPL-02	-	YAACN-3-0002	YAAV-05-M6x15	-	YAAL-05-4

Turning - Holder - External

External Holders for DC** Insert

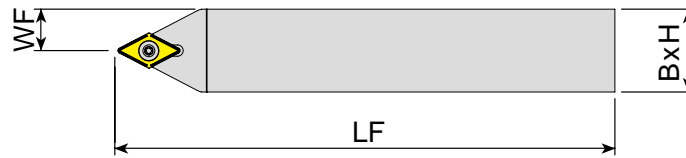

: p. 79 unit:mm

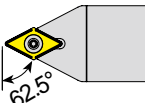
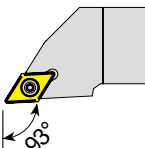
Series	Designation	EDP 2700..		H	B	WF	LF	Insert	
		R	L						
 SDNCN (Screw Type 62.5°)	SDNCN 0808E 07	0723		08	08	4	70	DC0702	
	SDNCN 1010E 07	0724		10	10	5	70		
	SDNCN 1212F 07	0123		12	12	6	80		
	SDNCN 1616H 07	0725		16	16	8	100		
		SDNCN 1616H 11	0124		16	16	8	100	DC11T3
		SDNCN 2020K 11	0125		20	20	10	125	
		SDNCN 2525M 11	0126		25	25	12.5	150	
		SDNCN 3232P 11	0726		32	32	16	170	
 SDJCR/L (Screw Type 93°)	SDJCR/L 0808E 07	0713	0714	08	08	10	70	DC0702	
	SDJCR/L 1010E 07	0715	0716	10	10	12	70		
	SDJCR/L 1212F 07	0113	0114	12	12	16	80		
	SDJCR/L 1616H 07	0717	0718	16	16	20	100		
		SDJCR/L 1616H 11	0117	0118	16	16	20	100	DC11T3
		SDJCR/L 2020K 11	0119	0120	20	20	25	125	
		SDJCR/L 2525M 11	0719	0720	25	25	32	150	
		SDJCR/L 3232P 11	0721	0722	32	32	40	170	

Series	Size	Screw	Shim	Shim Screw	Torx Key
SDNCN	..07	Y4008-M2.5x6	-	-	Y80-T08
	..11	Y4015-M3.5x14	YAADN-2-0001	YAAV-06-M3.5x11	Y80-T15
SDJCR/L	..07	Y4008-M2.5x6	-	-	Y80-T08
	..11	Y4015-M3.5x14	YAADN-2-0001	YAAV-06-M3.5x11	Y80-T15

External Holders for DN** Insert

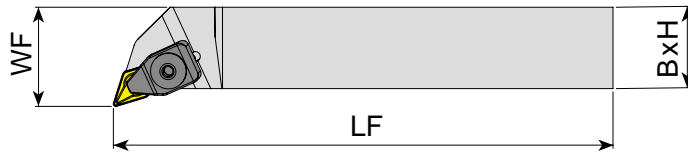

* 'C' Letter at Last : Optional Clamp Included

: p. 63 unit:mm

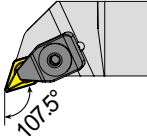
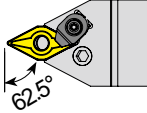
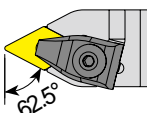
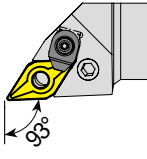
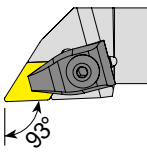
Series	Designation	EDP 2700.. R L	H	B	WF	LF	Insert
 TDHNR/L (Hole Clamp Type 107.5°)	TDHNR/L 2020K 15	0495 0496	20	20	25	125	DN1506
	TDHNR/L 2525M 15	0497 0498	25	25	32	150	
 PDNNN (Lever Type 62.5°)	PDNNN 2020K 15C	0515	20	20	10	125	DN1506
	PDNNN 2525M 15C	0516	25	25	12.5	150	
	PDNNN 3232P 15C	0517	32	32	16	170	
 TDNNN (Hole Clamp Type 62.5°)	TDNNN 2020K 15	0518	20	20	10	125	DN1506
	TDNNN 2525M 15	0519	25	25	12.5	150	
	TDNNN 3232P 15	0520	32	32	16	170	
 PDJNR/L (Lever Type 93°)	PDJNR/L 2020K 15C	0500 0501	20	20	25	125	DN1506
	PDJNR/L 2525M 15C	0502 0503	25	25	32	150	
	PDJNR/L 3232P 15C	0504 0505	32	32	40	170	
	PDJNR/L 4040S 15C	- 0506	40	40	50	250	
 TDJNR/L (Hole Clamp Type 93°)	TDJNR/L 2020K 15	0507 0508	20	20	25	125	DN1506
	TDJNR/L 2525M 15	0509 0510	25	25	32	150	
	TDJNR/L 3232P 15	0511 0512	32	32	40	170	
	TDJNR/L 4040S 15	0513 0514	40	40	50	250	

Series	Size	Lever	Lever Screw	Clamp	Clamp Screw	Upper Ring	Lower Ring	Shim	Shim Screw	Shim Pin	Allen Key
TDHNR/L	..15	-	-	YATK-02	YAKV-30-M6x22	YABPL-01	YAS-01	YAADN-3-0001	YAAV-02-M5x12	-	YAAL-03-3
PDNNN	..15C	YAPL-03	YALV-03-M8x19	YACK-05	Y4015-M4x11	-	-	YAADN-3-0001	-	YAAV-02	YAAL-03-3
TDNNN	..15	-	-	YATK-02	YAKV-30-M6x22	YABPL-01	YAS-01	YAADN-3-0001	YAAV-02-M5x12	-	YAAL-03-3
PDJNR/L	..15C	YAPL-03	YALV-03-M8x19	YACK-05	Y4015-M4x11	-	-	YAADN-3-0001	-	YAAV-02	YAAL-03-3
TDJNR/L	..15	-	-	YATK-02	YAKV-30-M6x22	YABPL-01	YAS-01	YAADN-3-0001	YAAV-02-M5x12	-	YAAL-03-3

Turning - Holder - External

External Holders for KN** Insert

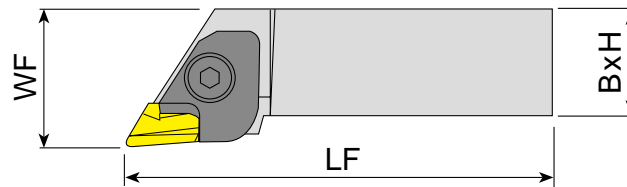

: p.66 unit:mm

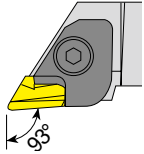
Series	Designation	EDP 2700..		H	B	WF	LF	Insert
		R	L					
 CKJNR/L (Top Clamp Type 93°)	CKJNR/L 2525M 16	0152	0153	25	25	31.5	150	KNUX1604
	CKJNR/L 3232P 16	0154	0155	32	32	40	170	

TURNING

PARTING & GROOVING

MILLING

DRILLING

TECHNICAL INFORMATION

Series	Size	Clamp	Clamp Screw	Spring	Upper Ring	Shim	Shim Screw	Allen Key
CKJNR	..16	YACK-01-R	YAKV-06-M6x20	YAKY-02	YABPL-01	YAKS-16-R	YAAV-01-M3x10	YAAL-05-4
CKJNL	..16	YACK-01-L	YAKV-06-M6x20	YAKY-02	YABPL-01	YAKS-16-L	YAAV-01-M3x10	YAAL-05-4

External Holders for RC** Insert

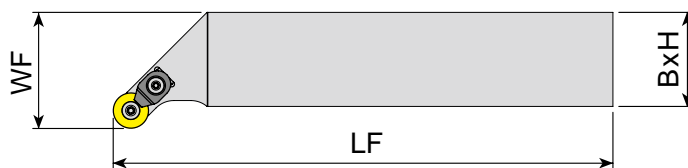

* 'C' Letter at Last : Optional Clamp Included

: p. 80 unit:mm

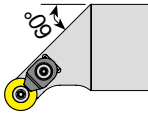
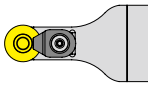
Series	Designation	EDP 2700..		H	B	WF	LF	Insert
		R	L					
 SRGCR/L (Screw Type 90°)	SRGCR/L 1616H 06	0739	0740	16	16	20	100	RC0602
	SRGCR/L 2020K 06	0741	0742	20	20	25	125	
	SRGCR/L 1616H 08C	0743	0744	16	16	32	100	RC0803
	SRGCR/L 2020K 08C	0745	0746	20	20	25	125	
	SRGCR/L 2525M 08C	0747	0748	25	25	32	150	RC10T3
	SRGCR/L 1616H 10C	0749	0750	16	16	20	100	
	SRGCR/L 2020K 10C	0751	0752	20	20	25	125	RC1204
	SRGCR/L 2525M 10C	0753	0754	25	25	32	150	
	SRGCR/L 3232P 10C	0755	0756	32	32	40	170	RC1204
	SRGCR/L 2020K 12C	0757	0758	20	20	25	125	
	SRGCR/L 2525M 12C	0759	0760	25	25	32	150	RC1204
	SRGCR/L 3232P 12C	0761	0762	32	32	40	170	
 SRDCN (Screw Type 90°)	SRDCN 1616H 06	0162		16	16	8	100	RC0602
	SRDCN 2020K 06	0163		20	20	10	125	
	SRDCN 2525M 06	0164		25	25	12.5	150	
	SRDCN 1616H 08C	0727		16	16	8	100	RC0803
	SRDCN 2020K 08C	0728		20	20	10	125	
	SRDCN 2525M 08C	0729		25	25	12.5	150	
	SRDCN 1616H 10C	0730		16	16	8	100	RC10T3
	SRDCN 2020K 10C	0731		20	20	10	125	
	SRDCN 2525M 10C	0732		25	25	12.5	150	
	SRDCN 3232P 10C	0733		32	32	16	170	RC1204
	SRDCN 2020K 12C	0734		20	20	10	125	
	SRDCN 2525M 12C	0735		25	25	12.5	150	
SRDCN 3232P 12C	0736		32	32	16	170		

Series	Size	Clamp	Clamp Screw	Screw	Torx Key
SRGCR/L	..06	-	-	Y3008-M2.5x6	Y80-T08
	..1616..08C	YACK-15	Y4015-M3.5x11	Y3008-M3x8	Y80-T08
	..10C	YACK-15	Y4015-M3.5x11	Y3008-M3x8	Y80-T15
	..12C	YACK-05	Y4015-M4x11	Y4015-M3.5x11	Y80-T15
SRDCN	..06	-	-	Y3008-M2.5x6	Y80-T08
	..08C	YACK-15	Y4015-M3.5x11	Y3008-M3x8	Y80-T08
	..10C	YACK-15	Y4015-M3.5x11	Y4015-M3.5x11	Y80-T15
	..12C	YACK-05	Y4015-M4x11	Y4015-M3.5x11	Y80-T15

Turning - Holder - External

External Holders for SC** Insert

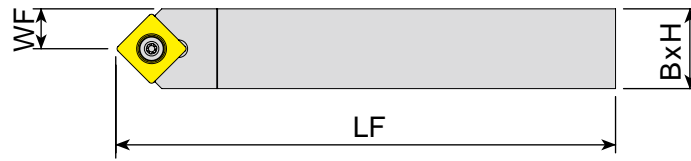

: p. 81 unit:mm

Series	Designation	EDP 2700..		H	B	WF	LF	Insert	
		R	L						
 SSDCN (Screw Type 45°)	SSDCN 1212F 09	0148		12	12	6	80	SC09T3	
	SSDCN 1616H 09	0149		16	16	8	100		
	SSDCN 2020K 09	0770		20	20	10	125		
		SSDCN 1616H 12	0771		16	16	8	100	SC1204
		SSDCN 2020K 12	0150		20	20	10	125	
		SSDCN 2525M 12	0151		25	25	12.5	150	
 SSSCR/L (Screw Type 45°)	SSSCR/L 1212F 09	0772	0773	12	12	16	80	SC09T3	
	SSSCR/L 1616H 09	0774	0775	16	16	20	100		
	SSSCR/L 2020K 09	0776	0777	20	20	25	125		
		SSSCR/L 1616H 12	0778	0779	16	16	20	100	SC1204
		SSSCR/L 2020K 12	0780	0781	20	20	25	125	
		SSSCR/L 2525M 12	0782	0783	25	25	32	150	

Series	Size	Screw	Shim	Shim Screw	Torx Key
SSDCN	..1212..09	Y4015-M3.5x11	-	-	Y80-T15
	..1616~2020..09	Y4015-M3.5x14	YAASN-2-0001	YAAV-06-M3.5x11	Y80-T15
	..1616..12	Y4020-M4.5x12	YAASN-2-0004	YAAV-10-M4.5x8	Y80-T20
	..2020~2525..12	Y1020-M4.5x16	YAASN-2-0004	YAAV-07-M4.5x13	Y80-T20
SSSCR/L	..1212..09	Y4015-M3.5x11	-	-	Y80-T15
	..1616~2020..09	Y4015-M3.5x14	YAASN-2-0001	YAAV-06-M3.5x11	Y80-T15
	..1616..12	Y4020-M4.5x12	YAASN-2-0004	YAAV-10-M4.5x8	Y80-T20
	..2020~2525..12	Y1020-M4.5x16	YAASN-2-0004	YAAV-07-M4.5x13	Y80-T20

External Holders for SN** Insert

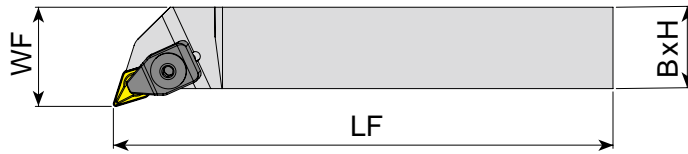

* 'C' Letter at Last : Optional Clamp Included

: p. 67 unit:mm

Series	Designation	EDP 2700..		H	B	WF	LF	Insert	
		R	L						
 PSDNN (Lever Type 45°)	PSDNN 2020K 12C	0530		20	20	10	125	SN1204	
	PSDNN 2525M 12C	0531		25	25	12.5	150		
	PSDNN 3232P 12C	0532		32	32	16	170		
 TSDNN (Hole Clamp Type 45°)	TSDNN 1616H 12	0533		16	16	8	100	SN1204	
	TSDNN 2020K 12	0534		20	20	10	125		
	TSDNN 2525M 12	0535		25	25	12.5	150		
 TSDNN 3232P 12		0536		32	32	16	170		
	 PSSNR/L (Lever Type 45°)	PSSNR/L 2020K 12C	0548	0549	20	20	25	125	SN1204
		PSSNR/L 2525M 12C	0550	0551	25	25	32	150	
PSSNR/L 3232P 12C		0552	0553	32	32	40	170		
 TSSNR/L (Hole Clamp Type 45°)	TSSNR/L 2020K 12	0554	0555	20	20	25	125	SN1204	
	TSSNR/L 2525M 12	0556	0557	25	25	32	150		
	TSSNR/L 3232P 12	0558	0559	32	32	40	170		
 PSBNR/L (Lever Type 75°)	PSBNR/L 2020K 12	0430	0525	20	20	17	125	SN1204	
	PSBNR/L 2525M 12C	0526	0527	25	25	22	150		
 PSKNR/L (Lever Type 75°)	PSKNR/L 2020K 12C	0537		20	20	25	125	SN1204	
	PSKNR/L 2525M 12C	0538	0539	25	25	32	150		
	PSKNR/L 3232P 12C	0540	0541	32	32	40	170		
 TSKNR/L (Hole Clamp Type 75°)	TSKNR/L 2020K 12	0542	0543	20	20	25	125	SN1204	
	TSKNR/L 2525M 12	0544	0545	25	25	32	150		
	TSKNR/L 3232P 12	0546	0547	32	32	40	170		

Series	Size	Lever	Lever Screw	Clamp	Clamp Screw	Upper Ring	Lower Ring	Shim	Shim Screw	Shim Pin	Allen Key
PSDNN	..12C	YAPL-02	YALV-03-M8x19	YACK-05	Y4015-M4x11	-	-	YAASN-3-0004	-	YAAY-02	YAAL-03-3
TSDNN	..12	-	-	YATK-02	YAKV-30-M6x22	YABPL-01	YAS-01	YAASN-3-0004	YAAV-02-M5x12	-	YAAL-03-3
PSSNR/L	..12C	YAPL-02	YALV-03-M8x19	YACK-05	Y4015-M4x11	-	-	YAASN-3-0004	-	YAAY-02	YAAL-03-3
TSSNR/L	..12	-	-	YATK-02	YAKV-30-M6x22	YABPL-01	YAS-01	YAASN-3-0004	YAAV-02-M5x12	-	YAAL-03-3
PSBNR/L	..12	YAPL-02	YALV-03-M8x19	-	-	-	-	YAASN-3-0004	-	YAAY-02	YAAL-03-3
	..12C	YAPL-02	YALV-03-M8x19	YACK-05	Y4015-M4x11	-	-	YAASN-3-0004	-	YAAY-02	YAAL-03-3
PSKNR/L	..12C	YAPL-02	YALV-03-M8x19	YACK-05	Y4015-M4x11	-	-	YAASN-3-0004	-	YAAY-02	YAAL-03-3
TSKNR/L	..12	-	-	YATK-02	YAKV-30-M6x22	YABPL-01	YAS-01	YAASN-3-0004	YAAV-02-M5x12	-	YAAL-03-3

Turning - Holder - External

External Holders for TC** Insert

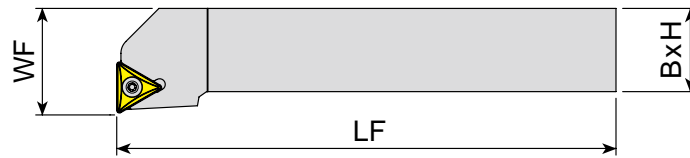

: p.82 unit:mm

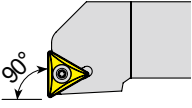
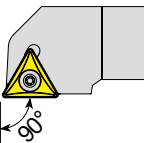
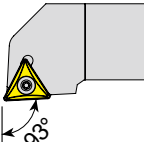
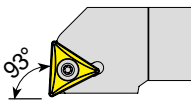
Series	Designation	EDP 2700..		H	B	WF	LF	Insert
		R	L					
 STFCR/L (Screw Type 90°)	STFCR/L 1212F 11	0099	0100	12	12	16	80	TC1102
	STFCR/L 1616H 11	0101	0102	16	16	20	100	
	STFCR/L 1616H 16	0105	0106	16	16	20	100	TC16T3
	STFCR/L 2020K 16	0107	0108	20	20	25	125	
	STFCR/L 2525M 16	0109	0110	25	25	32	150	
	STFCR/L 3232P 16	0784	0785	32	32	40	170	
 STGCLR/L (Screw Type 90°)	STGCLR/L 1212F 11	0786	0787	12	12	16	80	TC1102
	STGCLR/L 1616H 11	0433	0788	16	16	20	100	
	STGCLR/L 1616H 16	0789	0790	16	16	20	100	TC16T3
	STGCLR/L 2020K 16	0434	0791	20	20	25	125	
	STGCLR/L 2525M 16	0792	0793	25	25	32	150	
	STGCLR/L 3232P 16	0794	0795	32	32	40	170	
 STJCLR/L (Screw Type 93°)	STJCLR/L 1212F 11	0796	0797	12	12	16	80	TC1102
	STJCLR/L 1616H 11	0798	0799	16	16	20	100	
	STJCLR/L 1616H 16	0800	0801	16	16	20	100	TC16T3
	STJCLR/L 2020K 16	0802	0803	20	20	25	125	
	STJCLR/L 2525M 16	0804	0805	25	25	32	150	
	STJCLR/L 3232P 16	0806	0807	32	32	40	170	
 STUCLR/L (Screw Type 93°)	STUCLR/L 1212F 11	0808	0809	12	12	16	80	TC1102
	STUCLR/L 1616H 11	0810	0811	16	16	20	100	
	STUCLR/L 2020K 16	0812	0813	20	20	25	125	TC16T3
	STUCLR/L 2525M 16	0814	0815	25	25	32	150	
	STUCLR/L 3232P 16	0816	0817	32	32	40	170	

Series	Size	Screw	Shim	Shim Screw	Torx Key
STFCR/L	..11	Y4008-M2.5x6	-	-	Y80-T08
	..16	Y4015-M3.5x14	YAATN-2-0001	YAAV-06-M3.5x11	Y80-T15
STGCLR/L	..11	Y4008-M2.5x6	-	-	Y80-T08
	..16	Y4015-M3.5x14	YAATN-2-0001	YAAV-06-M3.5x11	Y80-T15
STJCLR/L	..11	Y4008-M2.5x6	-	-	Y80-T08
	..16	Y4015-M3.5x14	YAATN-2-0001	YAAV-06-M3.5x11	Y80-T15
STUCLR/L	..11	Y4008-M2.5x6	-	-	Y80-T08
	..16	Y4015-M3.5x14	YAATN-2-0001	YAAV-06-M3.5x11	Y80-T15

External Holders for TN** Insert

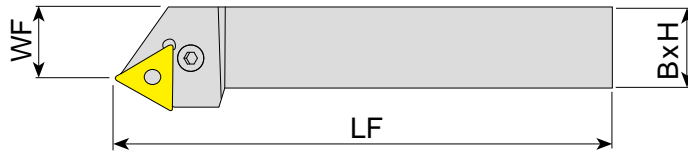

* 'C' Letter at Last : Optional Clamp Included

: p. 69 unit:mm

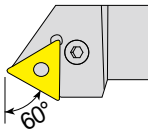
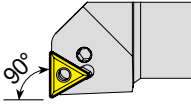
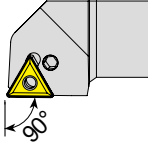
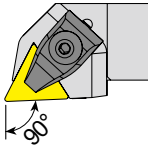
Series	Designation	EDP 2700..		H	B	WF	LF	Insert
		R	L					
 PTTNR/L (Lever Type 60°)	PTTNR/L 2020K 16	0429	0621	20	20	17	125	TN1604
	PTTNR/L 2525M 16	0622	0623	25	25	21.5	150	
	PTTNR/L 2525M 22C	0626	0627	25	25	20.5	150	TN2204
	PTTNR/L 3232P 22C	0628	0629	32	32	29	170	
 PTFNR/L (Lever Type 90°)	PTFNR/L 1616H 16	0560	0561	16	16	20	100	TN1604
	PTFNR/L 2020K 16	0049	0050	20	20	25	125	
	PTFNR/L 2525M 16	0051	0052	25	25	32	150	
	PTFNR/L 3232P 16	0562	0563	32	32	40	170	TN2204
 PTGNR/L (Lever Type 90°)	PTGNR/L 1616H 16	0568	0569	16	16	20	100	
	PTGNR/L 2020K 16	0055	0056	20	20	25	125	
	PTGNR/L 2525M 16	0057	0058	25	25	32	150	
	PTGNR/L 3232P 22C	0572	0573	32	32	40	170	TN2204
 TTGNR/L (Hole Clamp Type 90°)	TTGNR/L 2020K 16	0574	0575	20	20	25	125	TN1604
	TTGNR/L 2525M 16	0576	0577	25	25	32	150	
	TTGNR/L 3232P 16	0578	0579	32	32	40	170	
	TTGNR/L 2525M 22	0580	0581	25	25	32	150	TN2204
	TTGNR/L 3232P 22	0582	0583	32	32	40	170	
	TTGNR/L 4040S 22	0584	-	40	40	50	250	

▶ NEXT PAGE

Series	Size	Lever	Lever Screw	Clamp	Clamp Screw	Upper Ring	Lower Ring	Pin	Shim	Shim Screw	Shim Pin	Allen Key
PTTNR/L	..16	YAPL-01	YALV-02-M6x17	-	-	-	-	-	YAATN-3-0025	-	YAAY-01	YAAL-02-2.5
	..22C	YAPL-02	YALV-03-M8x19	YACK-05	Y4015-M4x11	-	-	-	YAATN-3-0015	-	YAAY-02	YAAL-03-3
PTFNR/L	..16	YAPL-01	YALV-02-M6x17	-	-	-	-	-	YAATN-3-0025	-	YAAY-01	YAAL-02-2.5
	..22C	YAPL-02	YALV-03-M8x19	YACK-05	Y4015-M4x11	-	-	-	YAATN-3-0015	-	YAAY-02	YAAL-03-3
PTGNR/L	..16	YAPL-01	YALV-02-M6x17	-	-	-	-	-	YAATN-3-0025	-	YAAY-01	YAAL-02-2.5
	..22C	YAPL-02	YALV-03-M8x19	YACK-05	Y4015-M4x11	-	-	-	YAATN-3-0015	-	YAAY-02	YAAL-02-2.5
TTGNR/L	..16	-	-	YATK-01	YAKV-01-M5x22	YABPL-01	-	-	YAATN-2-0002	YAAV-03-M5x12	-	YAAL-03-3
	..22	-	-	YATK-02	YAKV-30-M6x22	YABPL-01	YAS-01	-	YAATN-3-0015	YAAV-02-M5x12	-	YAAL-03-3

Turning - Holder - External

External Holders for TN** Insert

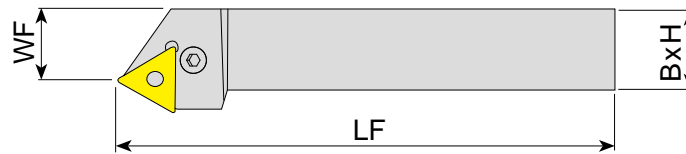

* 'C' Letter at Last : Optional Clamp Included

: p. 69 unit:mm

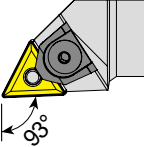
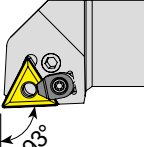
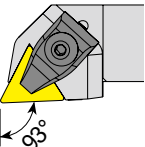
Series	Designation	EDP 2700..		H	B	WF	LF	Insert
		R	L					
 MTJNR/L (Pin + Top Clamp Type 93°)	MTJNR/L 2020K 16	0585	0586	20	20	25	125	TN1604
	MTJNR/L 2525M 16	0587	0588	25	25	32	150	
	MTJNR/L 3232P 16	0589	0590	32	32	40	170	
	TN2204	MTJNR/L 2525M 22	0591	0592	25	25	32	150
		MTJNR/L 3232P 22	0593	0594	32	32	40	170
		MTJNR/L 4040S 22	0595	0596	40	40	50	250
 PTJNR/L (Lever Type 93°)	PTJNR/L 1616H 16	0597	0598	16	16	20	100	TN1604
	PTJNR/L 2020K 16	0599	0600	20	20	25	125	
	PTJNR/L 2525M 16	0601	0602	25	25	32	150	
	TN2204	PTJNR/L 3232P 16	0603	0604	32	32	40	170
		PTJNR/L 2525M 22C	0605	0606	25	25	32	150
		PTJNR/L 3232P 22C	0607	0608	32	32	40	170
 TTJNR/L (Hole Clamp Type 93°)	TTJNR/L 2020K 16	0609	0610	20	20	25	125	TN1604
	TTJNR/L 2525M 16	0611	0612	25	25	32	150	
	TTJNR/L 3232P 16	0613	0614	32	32	40	170	
	TN2204	TTJNR/L 2525M 22	0615	0616	25	25	32	150
		TTJNR/L 3232P 22	0617	0618	32	32	40	170

Series	Size	Lever	Lever Screw	Clamp	Clamp Screw	Upper Ring	Lower Ring	Pin	Shim	Shim Screw	Shim Pin	Allen Key
MTJNR/L	..16	-	-	YAMK-04	YAKV-30-M6x22	YABPL-01	YAS-01	YAPM-01	YAATN-2-0002	-	-	YAAL-03-3
	..22	-	-	YAMK-04	YAKV-30-M6x22	YABPL-01	YAS-01	YAPM-02	YAATN-3-0015	-	-	YAAL-03-3
PTJNR/L	..16	YAPL-01	YALV-02-M6x17	-	-	-	-	-	YAATN-3-0025	-	YAAY-01	YAAL-02-2.5
	..22C	YAPL-02	YALV-03-M8x19	YACK-05	Y4015-M4x11	-	-	-	YAATN-3-0015	-	YAAY-02	YAAL-03-3
TTJNR/L	..16	-	-	YATK-01	YAKV-01-M5x22	YABPL-01	-	-	YAATN-2-0002	YAAV-03-M5x12	-	YAAL-03-3
	..22	-	-	YATK-02	YAKV-30-M6x22	YABPL-01	YAS-01	-	YAATN-3-0015	YAAV-02-M5x12	-	YAAL-03-3

External Holders for VB** Insert

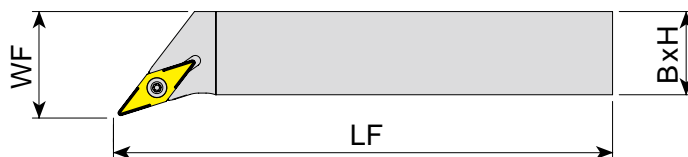

: p. 83 unit:mm

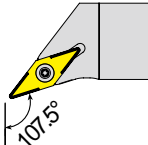
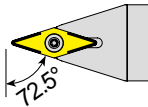
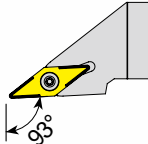
Series	Designation	EDP 2700..		H	B	WF	LF	Insert
		R	L					
 SVHBR/L (Screw Type 107.5°)	SVHBR/L 2020K 16	0818	0819	20	20	25	125	VB1604
	SVHBR/L 2525M 16	0820	0821	25	25	32	150	
	SVHBR/L 3232P 16	0822	0823	32	32	40	170	
 SVVBN (Screw Type 72.5°)	SVVBN 2020K 16	0131		20	20	10	125	VB1604
	SVVBN 2525M 16	0132		25	25	12.5	150	
	SVVBN 3232P 16	0827		32	32	16	170	
 SVJBR/L (Screw Type 93°)	SVJBR/L 1616H 16	0824	0825	16	16	20	100	VB1604
	SVJBR/L 2020K 16	0127	0128	20	20	25	125	
	SVJBR/L 2525M 16	0129	0130	25	25	32	150	
	SVJBR/L 3232P 16	0436	0826	32	32	40	170	

Series	Size	Screw	Shim	Shim Screw	Torx Key
SVHBR/L	..16	Y4015-M3.5x14	YAAVN-2-0002	YAAV-06-M3.5x11	Y80-T15
SVVBN	..16	Y4015-M3.5x14	YAAVN-2-0002	YAAV-06-M3.5x11	Y80-T15
SVJBR/L	..16	Y4015-M3.5x14	YAAVN-2-0002	YAAV-06-M3.5x11	Y80-T15

Turning - Holder - External

External Holders for VC** Insert

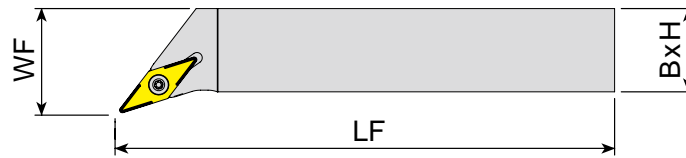

: p. 84 unit:mm

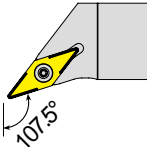
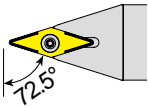
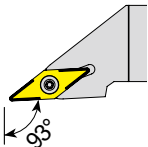
Series	Designation	EDP 2700..		H	B	WF	LF	Insert
		R	L					
 SVHCR/L (Screw Type 107.5°)	SVHCR/L 2020K 16	0828	0829	20	20	25	125	VC1604
	SVHCR/L 2525M 16	0830	0831	25	25	32	150	
	SVHCR/L 3232P 16	0832	0833	32	32	40	170	
 SVVCN (Screw Type 72.5°)	SVVCN 2525M 16	0147		25	25	12.5	150	VC1604
	SVVCN 3232P 16	0838		32	32	16	170	
 SVJCR/L (Screw Type 93°)	SVJCR/L 1212F 16	0834	0835	12	12	16	80	VC1604
	SVJCR/L 2020K 16	0139	0140	20	20	25	125	
	SVJCR/L 2525M 16	0141	0142	25	25	32	150	
	SVJCR/L 3232P 16	0836	0837	32	32	40	170	

Series	Size	Screw	Shim	Shim Screw	Torx Key
SVHCR/L	..16	Y4015-M3.5x14	YAAVN-2-0002	YAAV-06-M3.5x11	Y80-T15
SVVCN	..16	Y4015-M3.5x14	YAAVN-2-0002	YAAV-06-M3.5x11	Y80-T15
SVJCR/L	..1212..16	Y4015-M3.5x11	-	-	Y80-T15
	..2020~3232..16	Y4015-M3.5x14	YAAVN-2-0002	YAAV-06-M3.5x11	Y80-T15

External Holders for VN** Insert

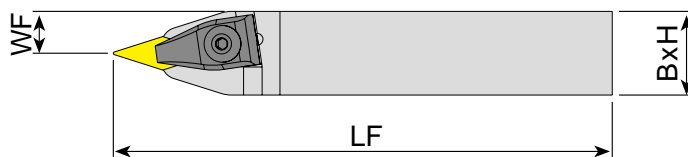

: p. 73 unit: mm

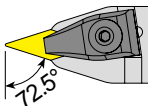
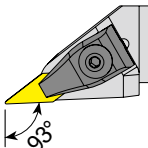
Series	Designation	EDP 2700..		H	B	WF	LF	Insert
		R	L					
 TVNN (Hole Clamp Type 72.5°)	TVNN 2020K 16	0642		20	20	10	125	VN1604
	TVNN 2525M 16	0643		25	25	12.5	150	
	TVNN 3232P 16	0644		32	32	16	170	
 TVJNR/L (Hole Clamp Type 93°)	TVJNR/L 2020K 16	0636	0637	20	20	25	125	VN1604
	TVJNR/L 2525M 16	0638	0639	25	25	32	150	
	TVJNR/L 3232P 16	0640	0641	32	32	40	170	

Series	Size	Clamp	Clamp Screw	Upper Ring	Lower Ring	Shim	Shim Screw	Allen Key
TVNN	..16	YATK-03	YAKV-30-M6x22	YABPL-01	YAS-01	YAAVN-2-0002	YAAV-04-M5x12	YAAL-03-3
TVJNR/L	..16	YATK-03	YAKV-30-M6x22	YABPL-01	YAS-01	YAAVN-2-0002	YAAV-04-M5x12	YAAL-03-3

Turning - Holder - External

External Holders for WN** Insert

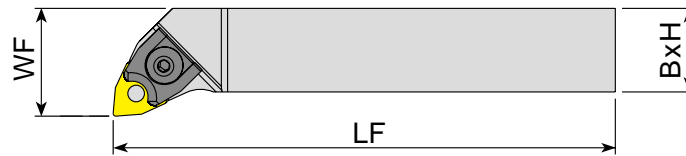

* 'C' Letter at Last : Optional Clamp Included

: p. 75 unit:mm

Series	Designation	EDP 2700..		H	B	WF	LF	Insert
		R	L					
<p>MWLNR/L (Pin + Top Clamp Type 95°)</p>	MWLNR/L 1616H 06	0645	0646	16	16	20	100	WN0604
	MWLNR/L 2020K 06	0021	0022	20	20	25	125	
	MWLNR/L 2525M 06	0023	0024	25	25	32	150	
	WN0804	MWLNR/L 2020K 08	0025	0026	20	20	25	125
		MWLNR/L 2525M 08	0027	0028	25	25	32	150
		MWLNR/L 3232P 08	0029	0030	32	32	40	170
<p>PWLNR/L (Lever Type 95°)</p>	PWLNR/L 1616H 06	0647	0648	16	16	20	100	WN0604
	PWLNR/L 2020K 06	0649	0650	20	20	25	125	
	PWLNR/L 2525M 06	0651	0652	25	25	32	150	
	WN0804	PWLNR/L 1616H 08	0653	0654	16	16	20	100
		PWLNR/L 2020K 08C	0655	0656	20	20	25	125
		PWLNR/L 2525M 08C	0657	0658	25	25	32	150
		PWLNR/L 3232P 08C	0659	0660	32	32	40	170
<p>TWLNR/L (Hole Clamp Type 95°)</p>	TWLNR/L 1616H 06	0661	0662	16	16	20	100	WN0604
	TWLNR/L 2020K 06	0663	0664	20	20	25	125	
	TWLNR/L 2525M 06	0665	0666	25	25	32	150	
	WN0804	TWLNR/L 2020K 08	0667	0668	20	20	25	125
		TWLNR/L 2525M 08	0669	0670	25	25	32	150
		TWLNR/L 3232P 08	0671	0672	32	32	40	170
		TWLNR/L 4040S 08	0673	0674	40	40	50	250

Series	Size	Lever	Lever Screw	Clamp	Clamp Screw	Upper Ring	Lower Ring	Pin	Shim	Shim Screw	Shim Pin	Allen Key
MWLNR/L	..06	-	-	YAMK-01	YAKV-04-M5x17	-	-	YAPM-08	-	-	-	YAAL-03-3
	..08	-	-	YAMK-05	YAKV-03-M6x22	YABPL-01	YAS-01	YAPM-02	YAAWN-3-0001	-	-	YAAL-03-3
PWLNR/L	..06	YAPL-01	YALV-02-M6x17	-	-	-	-	-	YAAWN-SW317	-	YAAV-01	YAAL-02-2.5
	..08	YAPL-02	YALV-03-M8x19	-	-	-	-	-	YAAWN-3-0001	-	YAAV-02	YAAL-03-3
	..08C	YAPL-02	YALV-03-M8x19	YACK-05	Y4015-M4x11	-	-	-	YAAWN-3-0001	-	YAAV-02	YAAL-03-3
TWLNR/L	..06	-	-	YATK-01	YAKV-01-M5x22	YABPL-01	-	-	YAAWN-SW317	YAAV-01-M3x10	-	YAAL-03-3
	..08	-	-	YATK-02	YAKV-30-M6x22	YABPL-01	YAS-01	-	YAAWN-3-0001	YAAV-02-M5x12	-	YAAL-03-3

Internal Holders for CC** Insert

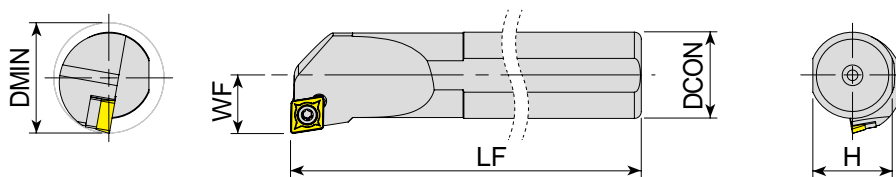

: p.78 unit:mm

Series	Designation	EDP 2700..		DMIN	DCON	H	WF	LF	Insert
		R	L						
	S08H - SCFCR/L 06	1102	1103	11	08	7.3	6	100	CC0602
X	S10K - SCFCR/L 06	1104	1105	13	10	9	7	125	
	S12K - SCFCR/L 06	1106	1107	16	12	11	9	125	
	S12K - SCFCR/L 09	1108	1109	16	12	11	9	125	CC09T3
X	S16P - SCFCR/L 09	1110	1111	20	16	14.8	11	170	
	S20R - SCFCR/L 09	1112	1113	25	20	18.3	13	200	
	S25S - SCFCR/L 09	1114	1115	32	25	23	17	250	CC1204
X	S25S - SCFCR/L 12	1116	-	32	25	23	17	250	

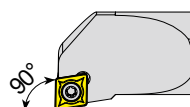

..SCFCR/L
(Screw Type 90°)

▶ NEXT PAGE

Series	Size	Screw	Shim	Shim Screw	Torx Key
..SCFCR/L	..06	Y4008-M2.5x6	-	-	Y80-T08
	..12..09	Y4015-M3.5x8	-	-	Y80-T15
	..16~20..09	Y4015-M3.5x9	-	-	Y80-T15
	..25..09	Y4015-M3.5x12	YAACN-2-0001	YAAV-08-M3.5x8	Y80-T15
	..12	Y4020-M4.5x12	YAACN-2-0003	YAAV-10-M4.5x8	Y80-T20

Turning - Holder - Internal

Internal Holders for CC** Insert

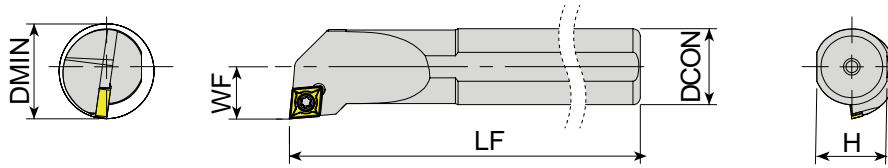

: p. 78 unit:mm

Series	Designation	EDP 2700.. R L	DMIN	DCON	H	WF	LF	Insert		
●	A08H - SCLCR/L 06	1117 1118	11	08	7.3	6	100	CC0602		
	A10H - SCLCR/L 06	1119 1120	13	10	9	7	100			
	A12H - SCLCR/L 06	1121 1122	16	12	11	9	100			
	S08H - SCLCR/L 06	1133 1134	11	08	7.3	6	100			
	X	S10K - SCLCR/L 06	1135 1136	13	10	9	7		125	
		S12K - SCLCR/L 06	1137 1138	16	12	11	9		125	
		S16P - SCLCR/L 06	1139 1140	20	16	14.8	11		170	
	●	A16M - SCLCR/L 09	1123 1124	20	16	14.8	11		150	CC09T3
		A20P - SCLCR/L 09	1125 1126	25	20	18.3	13		170	
		A25R - SCLCR/L 09	1127 1128	32	25	23	17		200	
A32S - SCLCR/L 09		1129 1130	40	32	30	22	250			
S12K - SCLCR/L 09		1141 1142	16	12	11	9	125			
S16P - SCLCR/L 09		- 1143	20	16	14.8	11	170			
X		S20R - SCLCR/L 09	1144 1145	25	20	18.3	13	200		
		S25S - SCLCR/L 09	1146 1147	32	25	23	17	250		
		S32T - SCLCR/L 09	1148 1149	40	32	30	22	300		
●		A25R - SCLCR/L 12	1131 1132	32	25	23	17	200	CC1204	
	S25S - SCLCR/L 12	1150 1151	32	25	23	17	250			
	X	S32T - SCLCR/L 12	1152 1153	40	32	30	22	300		
		S40U - SCLCR/L 12	1154 1155	50	40	37.5	27	350		
●	E08K - SCLCR/L 06	0325 1156	11	08	7.3	6	125	CC0602		
	E12Q - SCLCR/L 06	1157 1158	16	12	11	9	180			
	●	E16R - SCLCR/L 09	0329 1159	20	16	14.8	11	200	CC09T3	
		E20S - SCLCR/L 09	1160 1161	24	20	18.3	13	250		

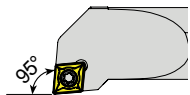

● **..-SCLCR/L**
(Screw Type 95°)

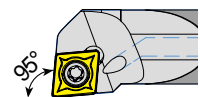

● **E..-SCLCR/L**
(Screw Type 95° Carbide)

Series	Size	Screw	Shim	Shim Screw	Torx Key
..SCLCR/L	..06	Y4008-M2.5x6	-	-	Y80-T08
	..12..09	Y4015-M3.5x8	-	-	Y80-T15
	..16~20..09	Y4015-M3.5x9	-	-	Y80-T15
	..25~32..09	Y4015-M3.5x12	YAACN-2-0001	YAAV-08-M3.5x8	Y80-T15
	..25~32..12	Y4020-M4.5x12	YAACN-2-0003	YAAV-10-M4.5x8	Y80-T20
	..40..12	Y1020-M4.5x16	YAACN-2-0003	YAAV-07-M4.5x13	Y80-T20
E..SCLCR/L	..06	Y4008-M2.5x6	-	-	Y80-T08
	..09	Y4015-M3.5x9	-	-	Y80-T15

Internal Holders for CN** Insert

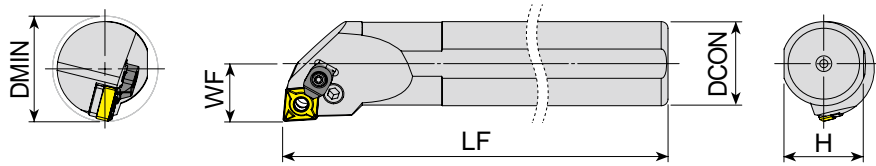

* 'C' Letter at Last : Optional Clamp Included

: p. 60 unit:mm

Series	Designation	EDP 2700.. R L	DMIN	DCON	H	WF	LF	Insert		
●	A25R - PCLNR/L 12C	0839 0840	32	25	23	17	200	CN1204		
	A32S - PCLNR/L 12C	0841 0842	40	32	30	22	250			
	A40T - PCLNR/L 12C	0843 0844	50	40	37.5	27	300			
	A50U - PCLNR/L 12C	0845 0846	63	50	47	35	350			
	S25S - PCLNR/L 12C	0863 0864	32	25	23	17	250			
	X S32T - PCLNR/L 12C	0865 0866	40	32	30	22	300			
	S40U - PCLNR/L 12C	0867 0868	50	40	37.5	27	350			
	S50V - PCLNR/L 12C	0869 0870	63	50	47	35	400			
	●	A32S - PCLNR/L 16C	0847 0848	40	32	30	22		250	CN1606
		A40T - PCLNR/L 16C	0849 0850	50	40	37.5	27		300	
A50U - PCLNR/L 16C		0851 0852	63	50	47	35	350			
S32T - PCLNR/L 16C		0871 0872	40	32	30	22	300			
X S40U - PCLNR/L 16C		0873 0874	50	40	37.5	27	350			
S50V - PCLNR/L 16C		0875 0876	63	50	47	35	400			
●		A40T - PCLNR/L 19C	0853 0854	50	40	37.5	27	300	CN1906	
		A50U - PCLNR/L 19C	0855 0856	63	50	47	35	350		
		X S40U - PCLNR/L 19C	0877 0878	50	40	37.5	27	350		
		S50V - PCLNR/L 19C	0879 0880	63	50	47	35	400		
X	S25S - TCLNR/L 12	0881 0882	32	25	23	17	250	CN1204		
	S32T - TCLNR/L 12	0883 0884	40	32	30	22	300			
	S40U - TCLNR/L 12	0885 0886	50	40	37.5	27	350			
	S50V - TCLNR/L 12	0887 0888	63	50	47	35	400			
	S32T - TCLNR/L 16	0889 0890	40	32	30	22	300			
X	S40U - TCLNR/L 16	0891 0892	50	40	37.5	27	350	CN1606		
S50V - TCLNR/L 16	0893 0894	63	50	47	35	400				

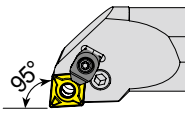

..PCLNR/L
(Lever Type 95°)

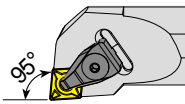

..TCLNR/L
(Hole Clamp Type 95°)

Series	Size	Lever	Lever Screw	Clamp	Clamp Screw	Upper Ring	Lower Ring	Shim	Shim Screw	Shim Pin	Allen Key
..PCLNR/L	..25..12C	YAPL-02	YALV-08-M8x16	YACK-05	Y4015-M4x11	-	-	YAACN-3-0001	-	YAAY-02	YAAL-03-3
	..32~50..12C	YAPL-02	YALV-03-M8x19	YACK-05	Y4015-M4x11	-	-	YAACN-3-0001	-	YAAY-02	YAAL-03-3
	..16C	YAPL-04	YALV-04-M8x22	YACK-09	YAAV-05-M6x15	-	-	YAACN-3-0002	-	YAAY-03	YAAL-03-3
	..19C	YAPL-05	YALV-05-M10x27	YACK-09	YAAV-05-M6x15	-	-	YAACN-3-0003	-	YAAY-04	YAAL-05-4
..TCLNR/L	..25..12	-	-	YATK-02	YAKV-30-M6x22	YABPL-01	YAS-01	YAACN-3-0001	YAAV-13-M5x8	-	YAAL-03-3
	..32~50..12	-	-	YATK-02	YAKV-30-M6x22	YABPL-01	YAS-01	YAACN-3-0001	YAAV-02-M5x12	-	YAAL-03-3
	..16	-	-	YATK-04	YAKV-19-M7x25	YABPL-02	-	YAACN-3-0002	YAAV-05-M6x15	-	YAAL-05-4

Turning - Holder - Internal

Internal Holders for DC** Insert

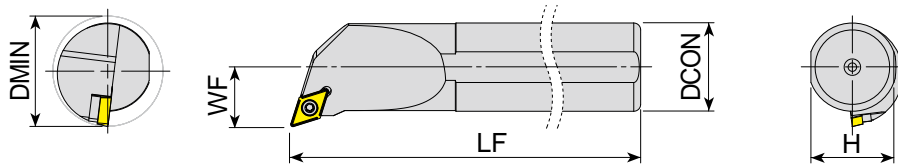

: p. 79 unit:mm

Series	Designation	EDP 2700.. R L	DMIN	DCON	H	WF	LF	Insert		
●	A10H - SDQCR/L 07	1172 1173	13	10	9	7	100	DC0702		
	A12H - SDQCR/L 07	1174 1175	16	12	11	9	100			
	A16M - SDQCR/L 07	1176 1177	20	16	14.8	11	150			
	A20P - SDQCR/L 07	1178 1179	25	20	18.3	13	170			
	S10K - SDQCR/L 07	1188 1189	13	10	9	7	125			
	X S12K - SDQCR/L 07	1190 1191	16	12	11	9	125			
	X S16P - SDQCR/L 07	1192 1193	20	16	14.8	11	170			
	X S20R - SDQCR/L 07	1194 1195	25	20	18.3	13	200			
	●	A16M - SDQCR/L 11	1180 1181	20	16	14.8	11		150	DC11T3
		A20P - SDQCR/L 11	1182 1183	25	20	18.3	13		170	
A25R - SDQCR/L 11		1184 1185	32	25	23	17	200			
A32S - SDQCR/L 11		1186 1187	40	32	30	22	250			
S16P - SDQCR/L 11		1196 1197	20	16	14.8	11	170			
S20R - SDQCR/L 11		1198 1199	25	20	18.3	13	200			
X S25S - SDQCR/L 11		1200 1201	32	25	23	17	250			
X S32T - SDQCR/L 11		1202 1203	40	32	30	22	300			
S40U - SDQCR/L 11	1204 1205	50	40	37.5	27	350				

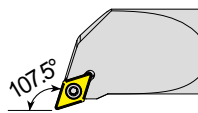

..SDQCR/L
(Screw Type 107.5°)

▶ NEXT PAGE

Series	Size	Screw	Shim	Shim Screw	Torx Key
..SDQCR/L	..07	Y4008-M2.5x6	-	-	Y80-T08
	..16..11	Y4015-M3.5x9	-	-	Y80-T15
	..20..11	Y4015-M3.5x11	-	-	Y80-T15
	..25..11	Y4015-M3.5x12	YAADN-2-0001	YAAV-08-M3.5x8	Y80-T15
	..32..11	Y4015-M3.5x14	YAADN-2-0001	YAAV-06-M3.5x11	Y80-T15

Internal Holders for DC** Insert

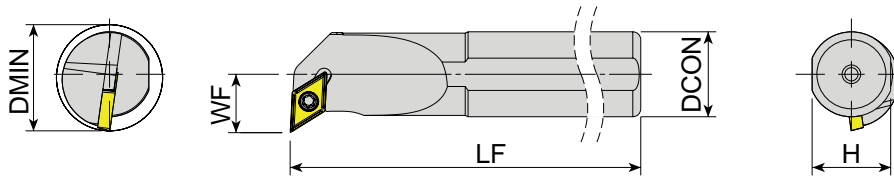

: p. 79 unit:mm

Series	Designation	EDP 2700..		DMIN	DCON	H	WF	LF	Insert	
		R	L							
●	A10H - SDUCR/L 07	1206	1207	13	10	9	8	100	DC0702	
	A12H - SDUCR/L 07	1208	1209	16	12	11	9	100		
	A16M - SDUCR/L 07	1210	1211	20	16	14.8	11	150		
	A20P - SDUCR/L 07	1212	1213	25	20	18.3	13	170		
	S10K - SDUCR/L 07	1222	1223	13	10	9	8	125		
	X S12K - SDUCR/L 07	1224	1225	16	12	11	9	125		
	X S16P - SDUCR/L 07	1226	1227	20	16	14.8	11	170		
	X S20R - SDUCR/L 07	1228	1229	25	20	18.3	13	200		
●	A16M - SDUCR/L 11	1214	1215	20	16	14.8	11	150	DC11T3	
	A20P - SDUCR/L 11	1216	1217	25	20	18.3	13	170		
	A25R - SDUCR/L 11	1218	1219	32	25	23	17	200		
	A32S - SDUCR/L 11	1220	1221	40	32	30	22	250		
	S16P - SDUCR/L 11	1230	1231	20	16	14.8	11	170		
	S20R - SDUCR/L 11	1232	1233	25	20	18.3	13	200		
	X S25S - SDUCR/L 11	1234	1235	32	25	23	17	250		
	X S32T - SDUCR/L 11	1236	1237	40	32	30	22	300		
	S40U - SDUCR/L 11	1238	1239	50	40	37.5	27	350		
	S50V - SDUCR/L 11	-	1240	63	50	47	35	400		
●	E10M - SDUCR/L 07	1241	1242	13	10	9	8	150	DC0702	
	E12Q - SDUCR/L 07	1243	1244	16	12	11	9	180		
	●	E16R - SDUCR/L 11	0339	1245	20	16	14.8	11	200	DC11T3
		E20S - SDUCR/L 11	1246	1247	23	20	18.3	12	250	

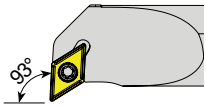

..SDUCR/L
(Screw Type 93°)

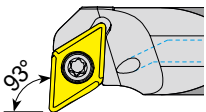

E..SDUCR/L
(Screw Type 93° Carbide)

Series	Size	Screw	Shim	Shim Screw	Torx Key
..SDUCR/L	..07	Y4008-M2.5x6	-	-	Y80-T08
	..16..11	Y4015-M3.5x9	-	-	Y80-T15
	..20..11	Y4015-M3.5x11	-	-	Y80-T15
	..25..11	Y4015-M3.5x12	YAADN-2-0001	YAAV-08-M3.5x8	Y80-T15
	..32..11	Y4015-M3.5x14	YAADN-2-0001	YAAV-06-M3.5x11	Y80-T15
E..SDUCR/L	..07	Y4008-M2.5x6	-	-	Y80-T08
	..11	Y4015-M3.5x9	-	-	Y80-T15

Turning - Holder - Internal

Internal Holders for DN** Insert

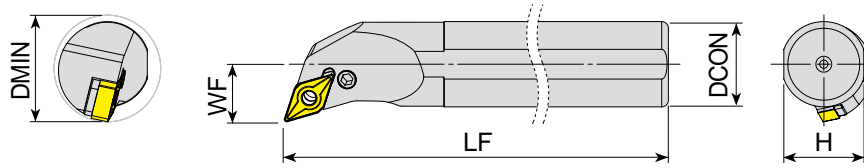

: p. 63 unit:mm

Series	Designation	EDP 2700.. R L	DMIN	DCON	H	WF	LF	Insert
 ..-PDQNR/L (Lever Type 107.5°)	● A32S - PDQNR/L 1504 0895 -	40 32 30 22 250	DN1504					
	● A40T - PDQNR/L 1504 0896 -	50 40 37.5 27 300						
	S32T - PDQNR/L 1504 0903 -	40 32 30 22 300						
	X S40U - PDQNR/L 1504 0904 -	50 40 37.5 27 350						
	S50V - PDQNR/L 1504 0905 -	63 50 47 35 400						
 ..-TDQNR/L (Hole Clamp Type 107.5°)	● A32S - PDQNR/L 15 0897 0898	40 32 30 22 250	DN1506					
	● A40T - PDQNR/L 15 0899 0900	50 40 37.5 27 300						
	A50U - PDQNR/L 15 0901 0902	63 50 47 35 350						
	S32T - PDQNR/L 15 0906 0907	40 32 30 22 300						
	X S40U - PDQNR/L 15 0908 0909	50 40 37.5 27 350						
S50V - PDQNR/L 15 0910 0911	63 50 47 35 400							
 ..-PDUNR/L (Lever Type 93°)	S25S - TDQNR/L 15 0912 0913	32 25 23 17 250	DN1506					
	X S32T - TDQNR/L 15 0914 0915	40 32 30 22 300						
	S40U - TDQNR/L 15 0916 0917	50 40 37.5 27 350						
	S50V - TDQNR/L 15 0918 0919	63 50 47 35 400						
	 ..-TDUNR/L (Hole Clamp Type 93°)	● A32S - PDUNR/L 15 0920 0921		40 32 30 22 250	DN1506			
● A40T - PDUNR/L 15 0922 0923		50 40 37.5 27 300						
A50U - PDUNR/L 15 0924 0925		63 50 47 35 350						
X S25S - PDUNR/L 15 0934 0935		32 25 23 19 250						
X S32T - PDUNR/L 15 0936 0937		40 32 30 22 300						
S40U - PDUNR/L 15 0938 0939	50 40 37.5 27 350							
S50V - PDUNR/L 15 0940 0941	63 50 47 35 400							
 ..-TDUNR/L (Hole Clamp Type 93°)	S25S - TDUNR/L 15 0942 0943	34 25 23 17 250	DN1506					
	X S32T - TDUNR/L 15 0944 0945	40 32 30 22 300						
	S40U - TDUNR/L 15 0946 0947	50 40 37.5 27 350						
	S50V - TDUNR/L 15 0948 0949	63 50 47 35 400						

Series	Size	Lever	Lever Screw	Clamp	Clamp Screw	Upper Ring	Lower Ring	Shim	Shim Screw	Shim Pin	Allen Key
..PDQNR/L	..15	YAPL-03	YALV-03-M8x19	-	-	-	-	YAADN-3-0001	-	YAAY-02	YAAL-03-3
	..1504	YAPL-03	YALV-03-M8x19	-	-	-	-	YAADN-2-0003	-	YAAY-02	YAAL-03-3
..PDUNR/L	..25..15	YAPL-03	YALV-08-M8x16	-	-	-	-	YAADN-3-0001	-	YAAY-02	YAAL-03-3
	..32~50..15	YAPL-03	YALV-03-M8x19	-	-	-	-	YAADN-3-0001	-	YAAY-02	YAAL-03-3
..TDQNR/L	..25..15	-	-	YATK-02	YAKV-30-M6x22	YABPL-01	-	YAADN-3-0001	YAAV-13-M5x8	-	YAAL-03-3
	..32~50..15	-	-	YATK-02	YAKV-30-M6x22	YABPL-01	YAS-01	YAADN-3-0001	YAAV-02-M5x12	-	YAAL-03-3
..TDUNR/L	..25..15	-	-	YATK-02	YAKV-30-M6x22	YABPL-01	YAS-01	YAADN-3-0001	YAAV-13-M5x8	-	YAAL-03-3
	..32~50..15	-	-	YATK-02	YAKV-30-M6x22	YABPL-01	YAS-01	YAADN-3-0001	YAAV-02-M5x12	-	YAAL-03-3

Turning - Holder - Internal Internal Holders for SN** Insert

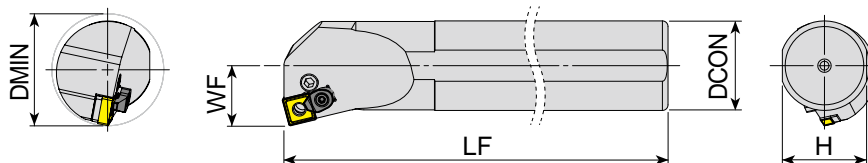

* 'C' Letter at Last : Optional Clamp Included

: p. 67 unit:mm

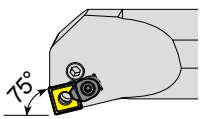
Series	Designation	EDP 2700.. R L	DMIN	DCON	H	WF	LF	Insert
 ..-PSKNR/L (Lever Type 75°)	X S25S - PSKNR/L 12C	0958 0959	32	25	23	17	250	SN1204
	S32T - PSKNR/L 12C	0960 0961	40	32	30	22	300	

Series	Size	Lever	Lever Screw	Clamp	Clamp Screw	Shim	Shim Pin	Allen Key
..PSKNR/L	..25..12C	YAPL-02	YALV-08-M8x16	YACK-05	Y4015-M4x11	YAASN-3-0004	YAAY-02	YAAL-03-3
	..32..12C	YAPL-02	YALV-03-M8x19	YACK-05	Y4015-M4x11	YAASN-3-0004	YAAY-02	YAAL-03-3

Turning - Holder - Internal

Internal Holders for TC** Insert

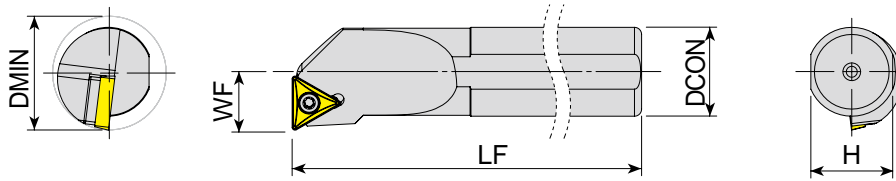

: p.82 unit:mm

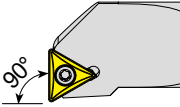
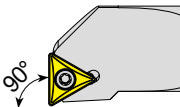
Series	Designation	EDP 2700.. R L	DMIN	DCON	H	WF	LF	Insert	
 ..-STFCR/L (Screw Type 90°)	X S12K - STFCR/L 11	1264 1265	17	12	11	9	125	TC1102	
	S16P - STFCR/L 11	1266 1267	20	16	14.8	11	170		
	S20R - STFCR/L 11	1268 1269	25	20	18.3	13	200		
	X	S16P - STFCR/L 16	1270 1271	20	16	14.8	11	170	TC16T3
		S20R - STFCR/L 16	1272 1273	25	20	18.3	13	200	
		S25S - STFCR/L 16	1274 1275	32	25	23	17	250	
		S32T - STFCR/L 16	1276 1277	40	32	30	22	300	
	S40U - STFCR/L 16	1278 -	50	40	37.5	27	350		
 ..-STUCR/L (Screw Type 93°)	X S12K - STUCR/L 11	1279 1280	17	12	11	9	125	TC1102	
	S16P - STUCR/L 11	1281 1282	20	16	14.8	11	170		
	S20R - STUCR/L 11	1283 1284	25	20	18.3	13	200		
	X	S16P - STUCR/L 16	1285 1286	20	16	14.8	11	170	TC16T3
		S20R - STUCR/L 16	1287 1288	25	20	18.3	13	200	
		S25S - STUCR/L 16	1289 1290	32	25	23	17	250	
		S32T - STUCR/L 16	1291 1292	40	32	30	22	300	
	S40U - STUCR/L 16	1293 1294	50	40	37.5	27	350		

Series	Size	Screw	Shim	Shim Screw	Torx Key
..-STFCR/L	..12~20..11	Y4008-M2.5x6	-	-	Y80-T08
	..16..16	Y4015-M3.5x9	-	-	Y80-T15
	..20..16	Y4015-M3.5x11	-	-	Y80-T15
	..25..16	Y4015-M3.5x14	YAATN-2-0001	YAAV-08-M3.5x8	Y80-T15
	..32~40..16	Y4015-M3.5x14	YAATN-2-0001	YAAV-06-M3.5x11	Y80-T15
..-STUCR/L	..11	Y4008-M2.5x6	-	-	Y80-T08
	..16..16	Y4015-M3.5x9	-	-	Y80-T15
	..20..16	Y4015-M3.5x11	-	-	Y80-T15
	..25..16	Y4015-M3.5x14	YAATN-2-0001	YAAV-08-M3.5x8	Y80-T15
	..32~40..16	Y4015-M3.5x14	YAATN-2-0001	YAAV-06-M3.5x11	Y80-T15

Internal Holders for TN** Insert

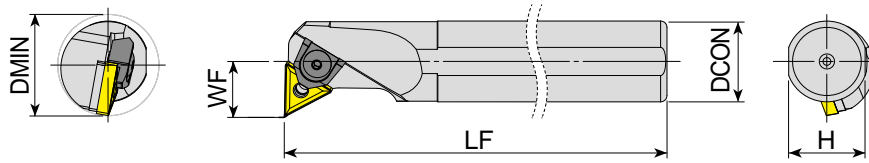

: p. 69 unit: mm

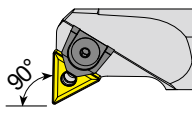
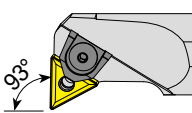
Series	Designation	EDP 2700..		DMIN	DCON	H	WF	LF	Insert	
		R	L							
 ..-MTFNR/L (Pin + Top Clamp Type 90°)	X	S20R - MTFNR/L 16	0972	-	25	20	18.3	14	200	TN1604
		S25S - MTFNR/L 16	0973	0974	32	25	23	17	250	
		S32T - MTFNR/L 16	0975	0976	40	32	30	22	300	
		S40U - MTFNR/L 16	0977	0978	50	40	37.5	27	350	
		S32T - MTFNR/L 22	0979	0980	40	32	30	22	300	
X	S40U - MTFNR/L 22	0981	0982	50	40	37.5	27	350	TN2204	
	S50V - MTFNR/L 22	0983	-	63	50	47	35	400		
	<hr/>									
 ..-MTUNR/L (Pin + Top Clamp Type 93°)	X	S20R - MTUNR/L 16	0998	0999	25	20	18.3	13	200	TN1604
		S25S - MTUNR/L 16	1000	1001	32	25	23	17	250	
		S32T - MTUNR/L 16	1002	1003	40	32	30	22	300	
		S40U - MTUNR/L 16	1004	1005	50	40	37.5	27	350	
		S50V - MTUNR/L 16	1006	1007	63	50	47	35	400	

▶ NEXT PAGE

Series	Size	Lever	Lever Screw	Clamp	Clamp Screw	Upper Ring	Lower Ring	Pin	Shim	Shim Screw	Shim Pin	Allen Key
..-MTFNR/L	..20..16	-	-	YAMK-02	YAKV-17-M5x15	-	-	YAPM-03	-	-	-	YAAL-03-3
	..25..16	-	-	YAMK-04	YAKV-30-M6x22	YABPL-01	YAS-01	YAPM-14	YAATN-2-0002	-	-	YAAL-03-3
	..32~40..16	-	-	YAMK-04	YAKV-30-M6x22	YABPL-01	YAS-01	YAPM-01	YAATN-2-0002	-	-	YAAL-03-3
	..22	-	-	YAMK-04	YAKV-30-M6x22	YABPL-01	YAS-01	YAPM-02	YAATN-3-0015	-	-	YAAL-03-3
..-MTUNR/L	..20..16	-	-	YAMK-02	YAKV-17-M5x15	-	-	YAPM-03	-	-	-	YAAL-03-3
	..25..16	-	-	YAMK-04	YAKV-30-M6x22	YABPL-01	YAS-01	YAPM-14	YAATN-2-0002	-	-	YAAL-03-3
	..32~50..16	-	-	YAMK-04	YAKV-30-M6x22	YABPL-01	YAS-01	YAPM-01	YAATN-2-0002	-	-	YAAL-03-3

Turning - Holder - Internal

Internal Holders for TN** Insert

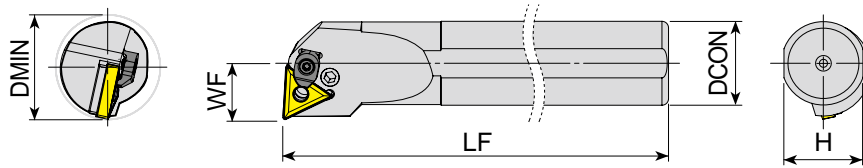

* 'C' Letter at Last : Optional Clamp Included

: p.69 unit:mm

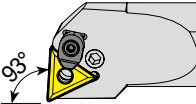
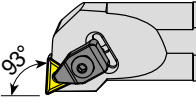
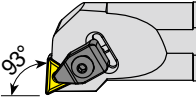
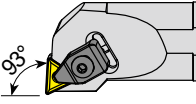
Series	Designation	EDP 2700.. R L	DMIN	DCON	H	WF	LF	Insert	
 ..-PTUNR/L (Lever Type 93°)	S16P - PTUNR/L 16	1014 1015	20	16	14.8	11	170	TN1604	
	S20R - PTUNR/L 16	1016 1017	25	20	18.3	13	200		
	X S25S - PTUNR/L 16C	1018 1019	32	25	23	17	250		
	S32T - PTUNR/L 16C	1020 1021	40	32	30	22	300		
	S40U - PTUNR/L 16C	1022 1023	50	40	37.5	27	350		
 ..-TTUNR/L (Hole Clamp Type 93°)	S32T - PTUNR/L 22C	1024 1025	40	32	30	22	300	TN2204	
	X S40U - PTUNR/L 22C	1026 1027	50	40	37.5	27	350		
	S50V - PTUNR/L 22C	1028 1029	63	50	47	35	400		
	 ..-TTUNR/L (Hole Clamp Type 93°)	X S25S - TTUNR/L 16	1030 1031	32	25	23	17	250	TN1604
		S32T - TTUNR/L 16	1032 1033	40	32	30	22	300	
 ..-TTUNR/L (Hole Clamp Type 93°)		X S25S - TTUNR/L 22	1034 1035	32	25	23	17	250	TN2204
		S32T - TTUNR/L 22	1036 1037	40	32	30	22	300	
		X S40U - TTUNR/L 22	1038 1039	50	40	37.5	27	350	
	S50V - TTUNR/L 22	1040 1041	63	50	47	35	400		

Series	Size	Lever	Lever Screw	Clamp	Clamp Screw	Upper Ring	Lower Ring	Pin	Shim	Shim Screw	Shim Pin	Allen Key
..PTUNR/L	..16..16	YAPL-08	YALV-07-M6x13	-	-	-	-	-	-	-	YAAY-07	YAAL-02-2.5
	..20..16	YAPL-01	YALV-01-M6x14	-	-	-	-	-	YAATN-3-0025	-	YAAY-01	YAAL-02-2.5
	..16C	YAPL-01	YALV-02-M6x17	YACK-05	Y4015-M4x11	-	-	-	YAATN-3-0025	-	YAAY-01	YAAL-02-2.5
	..22C	YAPL-02	YALV-03-M8x19	YACK-05	Y4015-M4x11	-	-	-	YAATN-3-0015	-	YAAY-02	YAAL-03-3
..TTUNR/L	..16	-	-	YATK-01	YAKV-01-M5x22	YABPL-01	-	-	YAATN-2-0002	YAAV-03-M5x12	-	YAAL-03-3
	..22	-	-	YATK-02	YAKV-30-M6x22	YABPL-01	YAS-01	-	YAATN-3-0015	YAAV-02-M5x12	-	YAAL-03-3

Internal Holders for VB** Insert

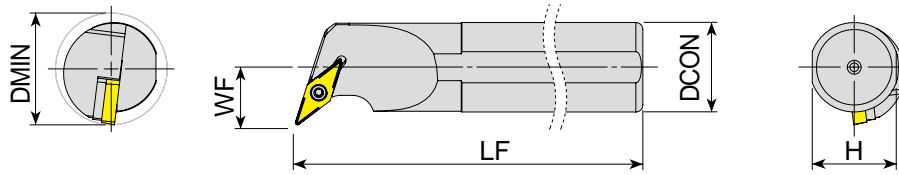

: p. 83 unit:mm

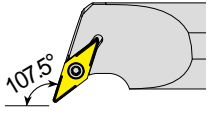
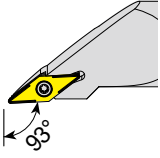
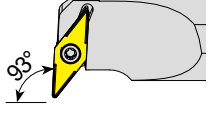
Series	Designation	EDP 2700..		DMIN	DCON	H	WF	LF	Insert
		R	L						
 ..SVQBR/L (Screw Type 107.5°)	● A20Q - SVQBR/L 16	1299	1300	30	20	18.3	20	180	VB1604
	● A25S - SVQBR/L 16	1301	1302	32	25	23	17	250	
	A32S - SVQBR/L 16	1303	1304	40	32	30	22	250	
	● S25S - SVQBR/L 16	1305	1306	32	25	23	17	250	
	X S32T - SVQBR/L 16	1307	1308	40	32	30	22	300	
	S40U - SVQBR/L 16	1309	1310	50	40	37.5	27	350	
 ..SVJBR/L (Screw Type 93°)	X S25S - SVJBR/L 16	1295	1296	32	25	23	17	250	VB1604
	X S32T - SVJBR/L 16	1297	1298	40	32	30	22	300	
 ..SVUBR/L (Screw Type 93°)	● A20Q - SVUBR/L 16	1311	-	30	20	18.3	20	180	VB1604
	● A32S - SVUBR/L 16	1312	1313	40	32	30	22	250	
	● S25S - SVUBR/L 16	1314	1315	32	25	23	19	250	
	X S32T - SVUBR/L 16	1316	1317	40	32	30	22	300	
	S40U - SVUBR/L 16	1318	1319	50	40	37.5	27	350	

Series	Size	Screw	Shim	Shim Screw	Torx Key
..SVJBR/L	..16	Y4015-M3.5x12	YAAVN-2-0002	YAAV-08-M3.5x8	Y80-T15
	..20..16	Y4015-M3.5x11	-	-	Y80-T15
..SVQBR/L	..25..16	Y4015-M3.5x14	YAAVN-2-0002	YAAV-06-M3.5x11	Y80-T15
	..25..16	Y4015-M3.5x14	YAAVN-2-0002	YAAV-08-M3.5x8	Y80-T15
	..32~40..16	Y4015-M3.5x14	YAAVN-2-0002	YAAV-06-M3.5x11	Y80-T15
..SVUBR/L	..20..16	Y4015-M3.5x11	-	-	Y80-T15
	..25~40..16	Y4015-M3.5x14	YAAVN-2-0002	YAAV-06-M3.5x11	Y80-T15

Turning - Holder - Internal

Internal Holders for VC** Insert

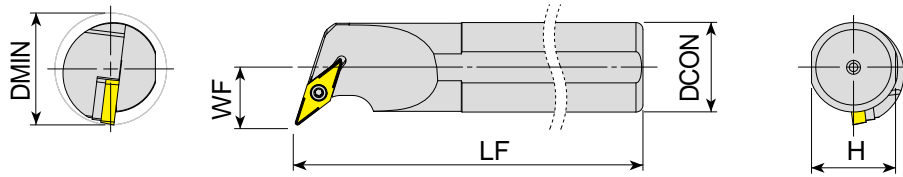

: p. 84 unit:mm

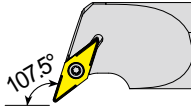
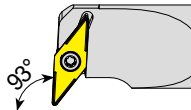
Series	Designation	EDP 2700..		DMIN	DCON	H	WF	LF	Insert
		R	L						
 ..-SVQCR/L (Screw Type 107.5°)	X S25S - SVQCR/L 16	1320	1321	32	25	23	17	250	VC1604
	S32T - SVQCR/L 16	1322	1323	40	32	30	22	300	
	S40U - SVQCR/L 16	1324	1325	50	40	37.5	27	350	
 ..-SVUCR/L (Screw Type 93°)	● A25R - SVUCR/L 16	1326	-	32	25	23	19	200	VC1604
	S25S - SVUCR/L 16	1327	1328	32	25	23	19	250	
	X S32T - SVUCR/L 16	1329	1330	40	32	30	22	300	
	S40U - SVUCR/L 16	1331	1332	50	40	37.5	27	350	

Series	Size	Screw	Shim	Shim Screw	Torx Key
..SVQCR/L	..25..16	Y4015-M3.5x14	YAAVN-2-0002	YAAV-08-M3.5x8	Y80-T15
	..32~40..16	Y4015-M3.5x14	YAAVN-2-0002	YAAV-06-M3.5x11	Y80-T15
..SVUCR/L	..16	Y4015-M3.5x14	YAAVN-2-0002	YAAV-06-M3.5x11	Y80-T15

Internal Holders for VN** Insert

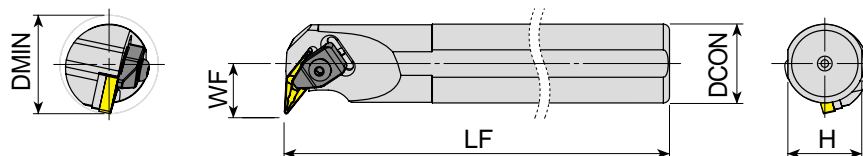

: p. 73 unit:mm

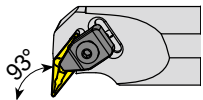
Series	Designation	EDP 2700..		DMIN	DCON	H	WF	LF	Insert	
		R	L							
 ..-TVUNR/L (Hole Clamp Type 93°)	X	S25S - TVUNR/L 16	1042	1043	36	25	23	20	250	VN1604
		S32T - TVUNR/L 16	1044	1045	40	32	30	22	300	
		S40U - TVUNR/L 16	1046	1047	50	40	37.5	27	350	

Series	Size	Clamp	Clamp Screw	Upper Ring	Shim	Shim Screw	Allen Key
..TVUNR/L	..16	YATK-01	YAKV-01-M5x22	YABPL-01	YAAVN-2-0002	YAAV-04-M5x12	YAAL-03-3

Turning - Holder - Internal

Internal Holders for WN** Insert

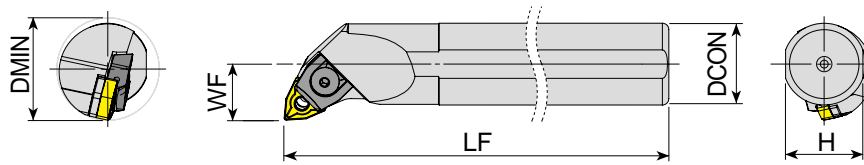

* 'C' Letter at Last : Optional Clamp Included

: p. 75 unit:mm

Series	Designation	EDP 2700.. R L	DMIN	DCON	H	WF	LF	Insert	
 ..-MWLNR/L (Pin + Top Clamp Type 95°)	X S16P - MWLNR/L 06	1064 1065	20	16	14.8	11	170	WN0604	
	X S20R - MWLNR/L 06	1066 1067	25	20	18.3	13	200		
	S25S - MWLNR/L 06	1068 1069	32	25	23	17	250		
	X	S25S - MWLNR/L 08	1070 1071	32	25	23	17	250	WN0804
		X S32T - MWLNR/L 08	1072 1073	40	32	30	22	300	
		S40U - MWLNR/L 08	1074 1075	50	40	37.5	27	350	
 ..-PWLNR/L (Lever Type 95°)	A20P - PWLNR/L 06	1048 1049	25	20	18.3	13	170	WN0604	
	● A25R - PWLNR/L 06	1050 1051	32	25	23	17	200		
	A32S - PWLNR/L 06	1052 1053	40	32	30	22	250		
	X S20R - PWLNR/L 06	1076 1077	25	20	18.3	13	200		
	X S25S - PWLNR/L 06	1078 1079	32	25	23	17	250		
	X	S32T - PWLNR/L 06	1080 1081	40	32	30	22	300	WN0804
		● A25R - PWLNR/L 08C	1054 1055	32	25	23	17	200	
		A32S - PWLNR/L 08C	1056 1057	40	32	30	22	250	
		● A40T - PWLNR/L 08C	1058 1059	50	40	37.5	27	300	
		A50U - PWLNR/L 08C	1060 1061	63	50	47	35	350	
S25S - PWLNR/L 08C		1082 1083	32	25	23	17	250		
S32T - PWLNR/L 08C		1084 1085	40	32	30	22	300		
S40U - PWLNR/L 08C		1086 1087	50	40	37.5	27	350		
S50V - PWLNR/L 08C		1088 1089	63	50	47	35	400		

Series	Size	Lever	Lever Screw	Clamp	Clamp Screw	Upper Ring	Lower Ring	Pin	Shim	Shim Screw	Shim Pin	Allen Key
..MWLNR/L	..16..06	-	-	YAMK-01	YAKV-17-M5x15	-	-	YAPM-09	-	-	-	-
	..20..06	-	-	YAMK-01	YAKV-04-M5x17	-	-	YAPM-10	-	-	-	-
	..25..06	-	-	YAMK-01	YAKV-04-M5x17	-	-	YAPM-08	-	-	-	-
	..25..08	-	-	YAMK-05	YAKV-27-M6x20	YABPL-01	YAS-01	YAPM-04	YAAWN-3-0001	-	-	YAAL-03-3
	..32~40..08	-	-	YAMK-05	YAKV-03-M6x22	YABPL-01	YAS-01	YAPM-02	YAAWN-3-0001	-	-	YAAL-03-3
..PWLNR/L	..20..06	YAPL-01	YALV-01-M6x14	-	-	-	-	-	YAAWN-SW317	-	YAAY-01	YAAL-02-2.5
	..25~32..06	YAPL-01	YALV-02-M6x17	-	-	-	-	-	YAAWN-SW317	-	YAAY-01	YAAL-02-2.5
	..08C	YAPL-02	YALV-03-M8x19	YACK-05	Y4015-M4x11	-	-	-	YAAWN-3-0001	-	YAAY-02	YAAL-03-3

Internal Holders for WN** Insert

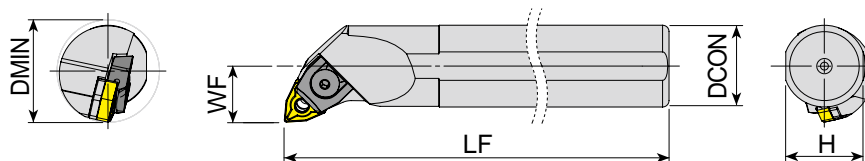

: p.75 unit:mm

Series	Designation	EDP 2700..		DMIN	DCON	H	WF	LF	Insert
		R	L						
X	S25S - TWLNR/L 06	1090	1091	32	25	23	17	250	WN0604
	S32T - TWLNR/L 06	1092	1093	40	32	30	22	300	
●	A40T - TWLNR/L 08	1062	-	50	40	37.5	27	300	WN0804
	A50U - TWLNR/L 08	1063	-	63	50	47	35	350	
X	S25S - TWLNR/L 08	1094	1095	32	25	23	17	250	
	S32T - TWLNR/L 08	1096	1097	40	32	30	22	300	
	S40U - TWLNR/L 08	1098	1099	50	40	37.5	27	350	
	S50V - TWLNR/L 08	1100	1101	63	50	47	35	400	

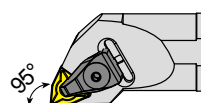







..-TWLNR/L
(Hole Clamp Type 95°)



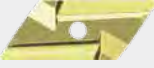

Series	Size	Lever	Lever Screw	Clamp	Clamp Screw	Upper Ring	Lower Ring	Pin	Shim	Shim Screw	Shim Pin	Allen Key
..-TWLNR/L	..06	-	-	YATK-01	YAKV-01-M5x22	YABPL-01	-	-	YAAWN-SW317	YAAV-01-M3x10	-	YAAL-03-3
	..25..08	-	-	YATK-02	YAKV-30-M6x22	YABPL-01	YAS-01	-	YAAWN-3-0001	YAAV-13-M5x8	-	YAAL-03-3
	..32~50..08	-	-	YATK-02	YAKV-30-M6x22	YABPL-01	YAS-01	-	YAAWN-3-0001	YAAV-02-M5x12	-	YAAL-03-3

Turning Inserts Overview

Negative Inserts

Shape	Series	Size				Page
C 	CNMA	12	16	19	60	
	CNMG	12	16	19		
D 	DNMA	1504	1506		63	
	DNMG	1504	1506			
K 	KNUX	16			66	
S 	SNMA	12	15		67	
	SNMG	12				
T 	TNMA	16			69	
	TNMG	16	22			
	TNMX	16			72	
V 	VNMA	16			73	
	VNMG	16				
W 	WNMA		08		75	
	WNMG	06	08			

Positive Inserts

Shape	Series	Size				Page
C 	CCGT		09	12	78	
	CCMT	06	09	12		
D 	DCGT		11		79	
	DCMT	07	11			
R 	RCMT	06	08	10	12	80
S 	SCMT	09	12			81
T 	TCGT		16			82
	TCMT	11	16			
V 	VBMT	16				83
	VCGT / VCMT	16				84

Turning Inserts - Negative CNMG / CNMA (80° Negative)

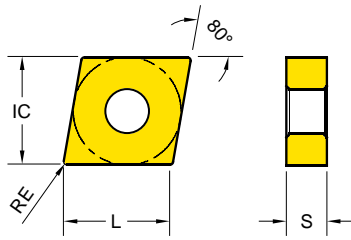

Series	L	IC	S
CN** 1204	12	12.7	4.76
CN** 1606	16	15.88	6.35
CN** 1906	19	19.05	6.35





TURNING

PARTING & GROOVING

MILLING

DRILLING

TECHNICAL INFORMATION

CNMA CNMG	Designation	RE	Fn (mm/rev.)	Ap (mm)	EDP 2200..															
					YG1001	YG3010	YG3020	YG3030	YG801	YG211	YG213	YG214	YG100	YG10						
..MA  Cast iron	CNMA 120404	0.4	0.15~0.5	0.5~2.5	●	●														
	CNMA 120408	0.8	0.15~0.5	1~3.5	●	●														
	CNMA 120412	1.2	0.15~0.5	1.5~5	●	●														
	CNMA 160612	1.2	0.15~0.5	1.5~5	●	●														
	CNMA 160616	1.6	0.15~0.5	2~5	●	●														
	CNMA 190616	1.6	0.15~1	3~10	●	●														
-UF  Finishing	CNMG 120404 - UF	0.4	0.05~0.25	0.5~1.5		●	●	●	●											
	CNMG 120408 - UF	0.8	0.05~0.25	1~2.5		●	●	●	●											
-UL  Light Machining and Sticky Material	CNMG 120404 - UL	0.4	0.1~0.3	0.5~2		●	●	●												
	CNMG 120408 - UL	0.8	0.1~0.3	1~3		●	●	●												
	CNMG 120412 - UL	1.2	0.1~0.3	1.5~3.5		●	●	●												
-UM  Medium Machining Unstable condition	CNMG 120404 - UM	0.4	0.15~0.3	0.5~1.5		●	●	●												
	CNMG 120408 - UM	0.8	0.15~0.3	0.5~2	●	●	●	●												
	CNMG 120412 - UM	1.2	0.15~0.3	1.5~3.0	●	●	●	●												

●: Stock item ○: Order made item

Cutting Speed			Vc (m/min.)																			
ISO	VDI	Sub Group	YG1001		YG3010		YG3020		YG3030		YG801		YG211		YG213		YG214		YG100		YG10	
			Min	Max	Min	Max	Min	Max	Min	Max	Min	Max	Min	Max	Min	Max	Min	Max	Min	Max	Min	Max
P	1~5	Non-Alloyed Steel	220	480	170	450	180	380	150	350	120	200	-	-	-	-	-	-	-	-	-	-
	6~9	Low-Alloyed Steel	220	420	180	380	110	350	90	300	70	200	-	-	-	-	-	-	-	-	-	-
	10~11	High-Alloyed Steel	-	-	100	330	60	300	70	250	-	-	-	-	-	-	-	-	-	-	-	-
M	12~13	Ferritic & Martensitic	-	-	-	-	-	-	120	230	-	-	130	230	110	180	80	150	-	-	-	-
	14	Austenitic Stainless Steel	-	-	-	-	-	-	80	200	-	-	100	200	40	130	30	120	-	-	-	-
K	15~16	Grey Cast Iron	170	420	120	300	-	-	-	-	-	-	-	-	-	-	-	-	-	-	-	-
	17~18	Nodular Cast Iron	120	410	120	280	-	-	-	-	-	-	-	-	-	-	-	-	-	-	-	-
N	21~30	Non-Ferrous Metals (Al)	-	-	-	-	-	-	-	-	-	-	-	-	-	-	-	350	1200	250	800	
S	31~37	Superalloys & Titanium	-	-	-	-	-	-	35	80	-	-	30	90	20	40	20	40	-	-	-	-
H	38~41	Hard Materials	-	-	-	-	-	-	-	-	-	-	-	-	-	-	-	-	-	-	-	-

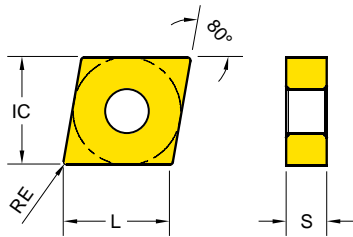

Turning Inserts - Negative CNMG / CNMA (80° Negative)



Series	L	IC	S
CN** 1204	12	12.7	4.76
CN** 1606	16	15.88	6.35
CN** 1906	19	19.05	6.35

EDP 2200..

● : Stock item ○ : Order made item

CNMA CNMG	Designation	RE	Fn (mm/rev.)	Ap (mm)	P05	P10	P30	P20	M15	M30	M40	N20	N20
					K10	K20	M20	P20	S10	S20	S30	N20	N20
-UG  Medium Machining at stable condition	CNMG 120404 - UG	0.4	0.2~0.4	0.5~2	●	●	●						
	CNMG 120408 - UG	0.8	0.2~0.4	1~3	○	○	○	●					
	CNMG 120412 - UG	1.2	0.2~0.4	1.5~4	○	○	○	○					
	CNMG 160608 - UG	0.8	0.20~0.40	1.5~5.0				○					
	CNMG 160612 - UG	1.2	0.2~0.4	1.5~5		○	○	○					
	CNMG 160616 - UG	1.6	0.2~0.4	1.8~5		○	○	○					
	CNMG 190608 - UG	0.8	0.20~0.50	3.0~7.0		○	○	○					
-UC  Cast iron and Medium roughing	CNMG 120404 - UC	0.4	0.2~0.4	0.5~2.5	○	○	○	○					
	CNMG 120408 - UC	0.8	0.2~0.4	1~4	○	○	○	○					
	CNMG 120412 - UC	1.2	0.2~0.4	1.5~4.5	○	○	○	○					
-UR  Roughing	CNMG 120408 - UR	0.8	0.3~0.5	1~4	○	○	○						
	CNMG 120412 - UR	1.2	0.3~0.5	1.5~5	○	○	○	○					
	CNMG 120416 - UR	1.6	0.3~0.5	2~5		○	○						
	CNMG 160612 - UR	1.2	0.3~0.5	1.5~5		○	○	○					
	CNMG 160616 - UR	1.6	0.3~0.5	2~5	○	○	○	○					
	CNMG 190608 - UR	0.8	0.3~0.8	3.0~9.0		○	○	○					
	CNMG 190612 - UR	1.2	0.3~0.8	3~9	○	○	○	○					
	CNMG 190616 - UR	1.6	0.3~0.8	3.0~9.0	○	○	○	○					

Cutting Speed			Vc (m/min.)																			
ISO	VDI	Sub Group	YG1001		YG3010		YG3020		YG3030		YG801		YG211		YG213		YG214		YG100		YG10	
			Min	Max	Min	Max	Min	Max	Min	Max	Min	Max	Min	Max	Min	Max	Min	Max	Min	Max	Min	Max
P	1-5	Non-Alloyed Steel	220	480	170	450	180	380	150	350	120	200	-	-	-	-	-	-	-	-	-	-
	6-9	Low-Alloyed Steel	220	420	180	380	110	350	90	300	70	200	-	-	-	-	-	-	-	-	-	-
	10-11	High-Alloyed Steel	-	-	100	330	60	300	70	250	-	-	-	-	-	-	-	-	-	-	-	-
M	12-13	Ferritic & Martensitic	-	-	-	-	-	-	120	230	-	-	130	230	110	180	80	150	-	-	-	-
	14	Austenitic Stainless Steel	-	-	-	-	-	-	80	200	-	-	100	200	40	130	30	120	-	-	-	-
K	15-16	Grey Cast Iron	170	420	120	300	-	-	-	-	-	-	-	-	-	-	-	-	-	-	-	-
	17-18	Nodular Cast Iron	120	410	120	280	-	-	-	-	-	-	-	-	-	-	-	-	-	-	-	-
N	21-30	Non-Ferrous Metals (Al)	-	-	-	-	-	-	-	-	-	-	-	-	-	-	-	350	1200	250	800	-
S	31-37	Superalloys & Titanium	-	-	-	-	-	-	35	80	-	-	30	90	20	40	20	40	-	-	-	-
H	38-41	Hard Materials	-	-	-	-	-	-	-	-	-	-	-	-	-	-	-	-	-	-	-	-

Turning Inserts - Negative CNMG / CNMA (80° Negative)

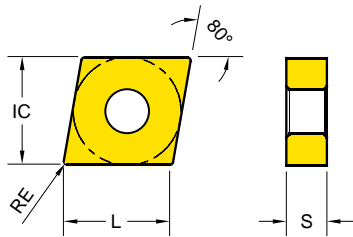

Series	L	IC	S
CN** 1204	12	12.7	4.76
CN** 1606	16	15.88	6.35
CN** 1906	19	19.05	6.35

TURNING

PARTING & GROOVING





MILLING

DRILLING

TECHNICAL INFORMATION

EDP 2200..

●: Stock item ○: Order made item

CNMA CNMG	Designation	RE	Fn (mm/rev.)	Ap (mm)	EDP 2200..											
					YG1001	YG3010	YG3020	YG3030	YG801	YG211	YG213	YG214	YG100	YG10		
-MF  Stainless steel Finishing	CNMG 120404 - MF	0.4	0.07~0.3	0.2~1.5							●	●				
	CNMG 120408 - MF	0.8	0.07~0.3	0.2~1.5							●	●				
-MM  Stainless steel Medium	CNMG 120404 - MM	0.4	0.2~0.35	0.5~3							●	●				
	CNMG 120408 - MM	0.8	0.2~0.35	1~3.5			●	●	●		●	●	●			
	CNMG 120412 - MM	1.2	0.2~0.35	1.5~3.5			●	●	●		●	●	●			
-MR  Stainless steel Roughing	CNMG 120408 - MR	0.8	0.3~0.55	1.2~5.5				●			●	●	●			
	CNMG 120412 - MR	1.2	0.3~0.55	1.5~5.5				●			●	●	●			
-KR  Cast Iron Heavy Roughing	CNMG 120408 - KR	0.8	0.30~0.60	1.0~5.0	●											
	CNMG 120412 - KR	1.2	0.30~0.60	1.5~5.0	●											

Cutting Speed			Vc (m/min.)																			
ISO	VDI	Sub Group	YG1001		YG3010		YG3020		YG3030		YG801		YG211		YG213		YG214		YG100		YG10	
			Min	Max	Min	Max	Min	Max	Min	Max	Min	Max	Min	Max	Min	Max	Min	Max	Min	Max	Min	Max
P	1~5	Non-Alloyed Steel	220	480	170	450	180	380	150	350	120	200	-	-	-	-	-	-	-	-	-	-
	6~9	Low-Alloyed Steel	220	420	180	380	110	350	90	300	70	200	-	-	-	-	-	-	-	-	-	-
	10~11	High-Alloyed Steel	-	-	100	330	60	300	70	250	-	-	-	-	-	-	-	-	-	-	-	-
M	12~13	Ferritic & Martensitic	-	-	-	-	-	-	120	230	-	-	130	230	110	180	80	150	-	-	-	-
	14	Austenitic Stainless Steel	-	-	-	-	-	-	80	200	-	-	100	200	40	130	30	120	-	-	-	-
K	15~16	Grey Cast Iron	170	420	120	300	-	-	-	-	-	-	-	-	-	-	-	-	-	-	-	-
	17~18	Nodular Cast Iron	120	410	120	280	-	-	-	-	-	-	-	-	-	-	-	-	-	-	-	-
N	21~30	Non-Ferrous Metals (Al)	-	-	-	-	-	-	-	-	-	-	-	-	-	-	-	350	1200	250	800	
S	31~37	Superalloys & Titanium	-	-	-	-	-	-	35	80	-	-	30	90	20	40	20	40	-	-	-	-
H	38~41	Hard Materials	-	-	-	-	-	-	-	-	-	-	-	-	-	-	-	-	-	-	-	-

Turning Inserts - Negative DNMG / DNMA (55° Negative)

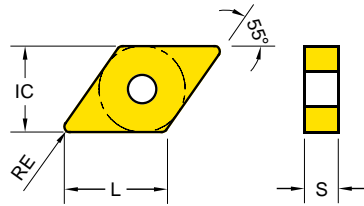

Series	L	IC	S
DN** 1504	14	12.7	4.76
DN** 1506	14	12.7	6.35

EDP 2200.. ● : Stock item ○ : Order made item

DNMA DNMG	Designation	RE	Fn (mm/rev.)	Ap (mm)	P05	P10	P20	P30	P20	M15	M30	M40	N20	N20
					K10	K20	M20	S10	S20	S30	N20	N20		
..MA Cast iron	DNMA 150408	0.8	0.15~0.5	1~3	●	●								
	DNMA 150412	1.2	0.15~0.5	1.5~4	●	●								
	DNMA 150608	0.8	0.15~0.5	1~3	●	●								
	DNMA 150612	1.2	0.15~0.5	1.5~4	●	●								
-UF Finishing	DNMG 150404 - UF	0.4	0.05~0.25	0.5~1.5		●	●	●	●					
	DNMG 150604 - UF	0.4	0.05~0.25	1~2		●	●	●	●					
	DNMG 150608 - UF	0.8	0.05~0.25	1.5~3.5		●	●	●	●					
-UL Light Machining and Sticky Material	DNMG 150404 - UL	0.4	0.10~0.3	0.5~3.0		●	●	●	●					
	DNMG 150408 - UL	0.8	0.10~0.3	1.0~3.0		●	●	●	●					
	DNMG 150412 - UL	1.2	0.10~0.3	1.5~3.0		●	●	●	●					
	DNMG 150604 - UL	0.4	0.1~0.3	0.5~2		●	●	●	●					
	DNMG 150608 - UL	0.8	0.1~0.3	1.5~3		●	●	●	●					
-UM Medium Machining Unstable condition	DNMG 150408 - UM	0.8	0.15~0.3	1.0~3.0		●	●	●	●					
	DNMG 150412 - UM	1.2	0.15~0.3	1.5~4		●	●	●	●					
	DNMG 150608 - UM	0.8	0.15~0.3	0.5~2		●	●	●	●					
	DNMG 150612 - UM	1.2	0.15~0.3	1.5~3.0		●	●	●	●					

Cutting Speed			Vc (m/min.)																			
ISO	VDI	Sub Group	YG1001		YG3010		YG3020		YG3030		YG801		YG211		YG213		YG214		YG100		YG10	
			Min	Max	Min	Max	Min	Max	Min	Max	Min	Max	Min	Max	Min	Max	Min	Max	Min	Max	Min	Max
P	1-5	Non-Alloyed Steel	220	480	170	450	180	380	150	350	120	200	-	-	-	-	-	-	-	-	-	-
	6-9	Low-Alloyed Steel	220	420	180	380	110	350	90	300	70	200	-	-	-	-	-	-	-	-	-	-
	10-11	High-Alloyed Steel	-	-	100	330	60	300	70	250	-	-	-	-	-	-	-	-	-	-	-	-
M	12-13	Ferritic & Martensitic	-	-	-	-	-	-	120	230	-	-	130	230	110	180	80	150	-	-	-	-
	14	Austenitic Stainless Steel	-	-	-	-	-	-	80	200	-	-	100	200	40	130	30	120	-	-	-	-
K	15-16	Grey Cast Iron	170	420	120	300	-	-	-	-	-	-	-	-	-	-	-	-	-	-	-	-
	17-18	Nodular Cast Iron	120	410	120	280	-	-	-	-	-	-	-	-	-	-	-	-	-	-	-	-
N	21-30	Non-Ferrous Metals (Al)	-	-	-	-	-	-	-	-	-	-	-	-	-	-	-	-	350	1200	250	800
S	31-37	Superalloys & Titanium	-	-	-	-	-	-	35	80	-	-	30	90	20	40	20	40	-	-	-	-
H	38-41	Hard Materials	-	-	-	-	-	-	-	-	-	-	-	-	-	-	-	-	-	-	-	-

Turning Inserts - Negative DNMG / DNMA (55° Negative)

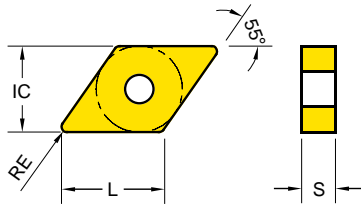

Series	L	IC	S
DN** 1504	14	12.7	4.76
DN** 1506	14	12.7	6.35



TURNING

PARTING & GROOVING

MILLING

DRILLING

TECHNICAL INFORMATION

DNMA DNMG	Designation	RE	Fn (mm/rev.)	Ap (mm)	EDP 2200..											
					YG1001	YG3010	YG3020	YG3030	YG801	YG211	YG213	YG214	YG100	YG10		
-UG  Medium Machining at stable condition	DNMG 150404 - UG	0.4	0.2~0.4	0.5~3.0			●									
	DNMG 150408 - UG	0.8	0.2~0.4	1~2.5	●	●	●	●	●							
	DNMG 150412 - UG	1.2	0.2~0.4	1.5~3	●		●	●								
	DNMG 150604 - UG	0.4	0.2~0.4	0.5~2		●	●	●								
	DNMG 150608 - UG	0.8	0.2~0.4	1~3	●	●	●	●	●							
	DNMG 150612 - UG	1.2	0.2~0.4	1.5~3.5	●	●	●	●								
-UC  Cast iron and Medium roughing	DNMG 150408 - UC	0.8	0.2~0.4	1~3	●	●		●								
	DNMG 150412 - UC	1.2	0.2~0.4	1.5~3.5	●	●		●								
	DNMG 150608 - UC	0.8	0.2~0.4	1~3	●	●	●	●								
	DNMG 150612 - UC	1.2	0.2~0.4	1.5~3.5	●	●	●	●								
-UR  Roughing	DNMG 150408 - UR	0.8	0.3~0.5	1~3.5		●										
	DNMG 150412 - UR	1.2	0.3~0.5	1.5~4		●										
	DNMG 150608 - UR	0.8	0.3~0.5	1.0~5.0	●	●	●									
	DNMG 150612 - UR	1.2	0.3~0.5	1.5~4		●	●	●	●							

●: Stock item ○: Order made item

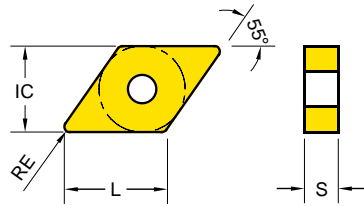

Cutting Speed			Vc (m/min.)																	
ISO	VDI	Sub Group	YG1001		YG3010		YG3020		YG3030		YG801		YG211		YG214		YG100		YG10	
			Min	Max	Min	Max	Min	Max	Min	Max	Min	Max	Min	Max	Min	Max	Min	Max	Min	Max
P	1~5	Non-Alloyed Steel	220	480	170	450	180	380	150	350	120	200	-	-	-	-	-	-	-	-
	6~9	Low-Alloyed Steel	220	420	180	380	110	350	90	300	70	200	-	-	-	-	-	-	-	-
	10~11	High-Alloyed Steel	-	-	100	330	60	300	70	250	-	-	-	-	-	-	-	-	-	-
M	12~13	Ferritic & Martensitic	-	-	-	-	-	-	120	230	-	-	130	230	110	180	80	150	-	-
	14	Austenitic Stainless Steel	-	-	-	-	-	-	80	200	-	-	100	200	40	130	30	120	-	-
K	15~16	Grey Cast Iron	170	420	120	300	-	-	-	-	-	-	-	-	-	-	-	-	-	
	17~18	Nodular Cast Iron	120	410	120	280	-	-	-	-	-	-	-	-	-	-	-	-	-	
N	21~30	Non-Ferrous Metals (Al)	-	-	-	-	-	-	-	-	-	-	-	-	-	-	350	1200	250	800
S	31~37	Superalloys & Titanium	-	-	-	-	-	-	35	80	-	-	30	90	20	40	20	40	-	-
H	38~41	Hard Materials	-	-	-	-	-	-	-	-	-	-	-	-	-	-	-	-	-	

Turning Inserts - Negative DNMG / DNMA (55° Negative)



Series	L	IC	S
DN** 1504	14	12.7	4.76
DN** 1506	14	12.7	6.35

EDP 2200.. ●: Stock item ○: Order made item

DNMA DNMG	Designation	RE	Fn (mm/rev.)	Ap (mm)	P05	P10	P20	P30	P20	M15	M30	M40	N20	N20
					K10	K20	M20	S10	S20	S30	N20	N20		
-MF  Stainless steel Finishing	DNMG 150404 - MF	0.4	0.07 ~ 0.3	0.2 ~ 1.5							●			
	DNMG 150408 - MF	0.8	0.07 ~ 0.3	0.2 ~ 1.5				●			0771			
	DNMG 150604 - MF	0.4	0.07 ~ 0.3	0.2 ~ 1.5						●				
	DNMG 150608 - MF	0.8	0.07 ~ 0.3	0.2 ~ 1.5				●		●				
-MM  Stainless steel Medium	DNMG 150404 - MM	0.4	0.2 ~ 0.35	0.5 ~ 3				●		●	●			
	DNMG 150408 - MM	0.8	0.2 ~ 0.35	1 ~ 3.5				●		●	●			
	DNMG 150412 - MM	1.2	0.2 ~ 0.35	1.5 ~ 3.5				●		●	●			
	DNMG 150604 - MM	0.4	0.2 ~ 0.35	0.5 ~ 3				●		●	●			
	DNMG 150608 - MM	0.8	0.2 ~ 0.35	1 ~ 3.5				●		●	●			
	DNMG 150612 - MM	1.2	0.2 ~ 0.35	1.5 ~ 3.5				●		●	●			
-MR  Stainless steel Roughing	DNMG 150408 - MR	0.8	0.3 ~ 0.55	2.0 ~ 5.5							●	●		
	DNMG 150412 - MR	1.2	0.3 ~ 0.55	2.0 ~ 5.5								●	●	
	DNMG 150608 - MR	0.8	0.3 ~ 0.55	2.0 ~ 5.5							●	●	●	
	DNMG 150612 - MR	1.2	0.3 ~ 0.55	2.0 ~ 5.5							●	●	●	●

Cutting Speed			Vc (m/min.)																			
ISO	VDI	Sub Group	YG1001		YG3010		YG3020		YG3030		YG801		YG211		YG213		YG214		YG100		YG10	
			Min	Max	Min	Max	Min	Max	Min	Max	Min	Max	Min	Max	Min	Max	Min	Max	Min	Max	Min	Max
P	1-5	Non-Alloyed Steel	220	480	170	450	180	380	150	350	120	200	-	-	-	-	-	-	-	-	-	-
	6-9	Low-Alloyed Steel	220	420	180	380	110	350	90	300	70	200	-	-	-	-	-	-	-	-	-	-
	10-11	High-Alloyed Steel	-	-	100	330	60	300	70	250	-	-	-	-	-	-	-	-	-	-	-	-
M	12-13	Ferritic & Martensitic	-	-	-	-	-	-	120	230	-	-	130	230	110	180	80	150	-	-	-	-
	14	Austenitic Stainless Steel	-	-	-	-	-	-	80	200	-	-	100	200	40	130	30	120	-	-	-	-
K	15-16	Grey Cast Iron	170	420	120	300	-	-	-	-	-	-	-	-	-	-	-	-	-	-	-	-
	17-18	Nodular Cast Iron	120	410	120	280	-	-	-	-	-	-	-	-	-	-	-	-	-	-	-	-
N	21-30	Non-Ferrous Metals (Al)	-	-	-	-	-	-	-	-	-	-	-	-	-	-	-	350	1200	250	800	-
S	31-37	Superalloys & Titanium	-	-	-	-	-	-	35	80	-	-	30	90	20	40	20	40	-	-	-	-
H	38-41	Hard Materials	-	-	-	-	-	-	-	-	-	-	-	-	-	-	-	-	-	-	-	-

Turning Inserts - Negative KNUX (55° - 2 Corners Single Side)

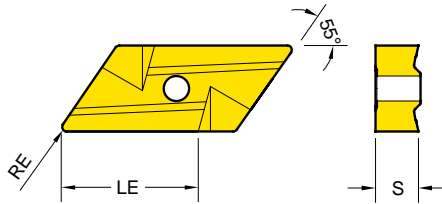

Series	LE	S
KN** 1604	15	4.76

EDP 2200..

●: Stock item ○: Order made item

KNUX	Designation	RE	Fn (mm/rev.)	Ap (mm)	P05	P10	P20	P30	P20	M15	M30	M40	N20	N20
					K10	K20	M20	S10	S20	S30				
					YG1001	YG3010	YG3020	YG3030	YG801	YG211	YG213	YG214	YG100	YG10
..UX Left	KNUX 160405 L	0.5	0.1 ~ 0.4	0.5 ~ 6		● 0249	● 0250	● 0251	● 0079					
..UX Right	KNUX 160405 R	0.5	0.1 ~ 0.4	0.5 ~ 6		● 0252	● 0253	● 0254	● 0080					

Cutting Speed			Vc (m/min.)																				
ISO	VDI	Sub Group	YG1001		YG3010		YG3020		YG3030		YG801		YG211		YG213		YG214		YG100		YG10		
			Min	Max	Min	Max	Min	Max	Min	Max	Min	Max	Min	Max	Min	Max	Min	Max	Min	Max	Min	Max	
P	1-5	Non-Alloyed Steel	220	480	170	450	180	380	150	350	120	200	-	-	-	-	-	-	-	-	-	-	-
	6-9	Low-Alloyed Steel	220	420	180	380	110	350	90	300	70	200	-	-	-	-	-	-	-	-	-	-	-
	10-11	High-Alloyed Steel	-	-	100	330	60	300	70	250	-	-	-	-	-	-	-	-	-	-	-	-	-
M	12-13	Ferritic & Martensitic	-	-	-	-	-	-	120	230	-	-	130	230	110	180	80	150	-	-	-	-	-
	14	Austenitic Stainless Steel	-	-	-	-	-	-	80	200	-	-	100	200	40	130	30	120	-	-	-	-	-
K	15-16	Grey Cast Iron	170	420	120	300	-	-	-	-	-	-	-	-	-	-	-	-	-	-	-	-	-
	17-18	Nodular Cast Iron	120	410	120	280	-	-	-	-	-	-	-	-	-	-	-	-	-	-	-	-	-
N	21-30	Non-Ferrous Metals (Al)	-	-	-	-	-	-	-	-	-	-	-	-	-	-	-	-	350	1200	250	800	-
S	31-37	Superalloys & Titanium	-	-	-	-	-	-	35	80	-	-	30	90	20	40	20	40	-	-	-	-	-
H	38-41	Hard Materials	-	-	-	-	-	-	-	-	-	-	-	-	-	-	-	-	-	-	-	-	-

Turning Inserts - Negative SNMG / SNMA (90° Negative)

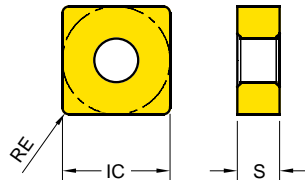

Series	IC	S
SN** 1204	12.7	4.76
SN** 1506	15.875	6.35

EDP 2200.. ● : Stock item ○ : Order made item

	SNMA SNMG	Designation	RE	Fn (mm/rev.)	Ap (mm)	EDP 2200..															
						YG1001	YG3010	YG3020	YG3030	YG801	YG211	YG213	YG214	YG100	YG10						
..MA		SNMA 120408	0.8	0.15~0.5	1~3.5	●															
		SNMA 120412	1.2	0.15~0.5	1.5~5	●															
		SNMA 150612	1.2	0.15~0.5	1.5~5	●															
-UF		SNMG 120404 - UF	0.4	0.05~0.25	0.5~1.5					●											
-UL		SNMG 120404 - UL	0.4	0.10~0.30	0.5~3.0			●													
		SNMG 120408 - UL	0.8	0.1~0.3	1~3		●	●	●												
-UM		SNMG 120408 - UM	0.8	0.15~0.30	1.0~3.0		●	●	●												
-UG		SNMG 120408 - UG	0.8	0.2~0.4	1~3		●	●	●	●											
		SNMG 120412 - UG	1.2	0.2~0.4	1.5~4		●	●	●												
		SNMG 120416 - UG	1.6	0.2~0.40	2.0~3.0		●														
-UC		SNMG 120408 - UC	0.8	0.2~0.4	1~4	●	●	●	●												
		SNMG 120412 - UC	1.2	0.2~0.4	1.5~4.5	●			●												

Cutting Speed			Vc (m/min.)																			
ISO	VDI	Sub Group	YG1001		YG3010		YG3020		YG3030		YG801		YG211		YG213		YG214		YG100		YG10	
			Min	Max	Min	Max	Min	Max	Min	Max	Min	Max	Min	Max	Min	Max	Min	Max	Min	Max	Min	Max
P	1-5	Non-Alloyed Steel	220	480	170	450	180	380	150	350	120	200	-	-	-	-	-	-	-	-	-	-
	6-9	Low-Alloyed Steel	220	420	180	380	110	350	90	300	70	200	-	-	-	-	-	-	-	-	-	-
	10-11	High-Alloyed Steel	-	-	100	330	60	300	70	250	-	-	-	-	-	-	-	-	-	-	-	-
M	12-13	Ferritic & Martensitic	-	-	-	-	-	-	120	230	-	-	130	230	110	180	80	150	-	-	-	-
	14	Austenitic Stainless Steel	-	-	-	-	-	-	80	200	-	-	100	200	40	130	30	120	-	-	-	-
K	15-16	Grey Cast Iron	170	420	120	300	-	-	-	-	-	-	-	-	-	-	-	-	-	-	-	-
	17-18	Nodular Cast Iron	120	410	120	280	-	-	-	-	-	-	-	-	-	-	-	-	-	-	-	-
N	21-30	Non-Ferrous Metals (Al)	-	-	-	-	-	-	-	-	-	-	-	-	-	-	-	350	1200	250	800	
S	31-37	Superalloys & Titanium	-	-	-	-	-	-	35	80	-	-	30	90	20	40	20	40	-	-	-	-
H	38-41	Hard Materials	-	-	-	-	-	-	-	-	-	-	-	-	-	-	-	-	-	-	-	-

Turning Inserts - Negative SNMG / SNMA (90° Negative)

Series	IC	S
SN** 1204	12.7	4.76

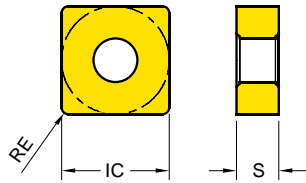

EDP 2200..

● : Stock item ○ : Order made item

SNMA SNMG	Designation	RE	Fn (mm/rev.)	Ap (mm)	P05	P10	P20	P30	P20	M15	M30	M40	N20	N20
					K10	K20	M20	S10	S20	S30				
					YG1001	YG3010	YG3020	YG3030	YG801	YG211	YG213	YG214	YG100	YG10
-UR Roughing	SNMG 120408 - UR	0.8	0.3 ~ 0.5	1 ~ 4.5		● 0392	● 0393	● 0394						
	SNMG 120412 - UR	1.2	0.3 ~ 0.5	1.5 ~ 5			● 0262	● 0263	● 0031					
-MF Stainless steel Finishing	SNMG 120408 - MF	0.8	0.07 ~ 0.3	0.2 ~ 1.5				● 0818		● 0653	● 0654	● 0817		
	SNMG 120412 - MF	1.2	0.07 ~ 0.3	0.2 ~ 1.5			● 0821			● 0655	● 0656	● 0820		
-MM Stainless steel Medium	SNMG 120408 - MM	0.8	0.2 ~ 0.35	1 ~ 3.5						● 0555	● 0556			
	SNMG 120412 - MM	1.2	0.2 ~ 0.35	1.5 ~ 3.5						● 0565	● 0566			
-MR Stainless steel Roughing	SNMG 120408 - MR	0.8	0.3 ~ 0.55	0.15 ~ 5.5						● 0657	● 0658	● 0819		
	SNMG 120412 - MR	1.2	0.3 ~ 0.55	0.15 ~ 5.5			● 0823			● 0659	● 0660	● 0822		
-KR Cast Iron Heavy Roughing	SNMG 120416 - KR	1.6	0.30 ~ 0.60	2.0 ~ 5.0	● 0730									

Cutting Speed			Vc (m/min.)																	
ISO	VDI	Sub Group	YG1001		YG3010		YG3020		YG3030		YG801		YG211		YG214		YG100		YG10	
			Min	Max	Min	Max	Min	Max	Min	Max	Min	Max	Min	Max	Min	Max	Min	Max	Min	Max
P	1~5	Non-Alloyed Steel	220	480	170	450	180	380	150	350	120	200	-	-	-	-	-	-	-	-
	6~9	Low-Alloyed Steel	220	420	180	380	110	350	90	300	70	200	-	-	-	-	-	-	-	-
	10~11	High-Alloyed Steel	-	-	100	330	60	300	70	250	-	-	-	-	-	-	-	-	-	-
M	12~13	Ferritic & Martensitic	-	-	-	-	-	-	120	230	-	-	130	230	110	180	80	150	-	-
	14	Austenitic Stainless Steel	-	-	-	-	-	-	80	200	-	-	100	200	40	130	30	120	-	-
K	15~16	Grey Cast Iron	170	420	120	300	-	-	-	-	-	-	-	-	-	-	-	-	-	-
	17~18	Nodular Cast Iron	120	410	120	280	-	-	-	-	-	-	-	-	-	-	-	-	-	-
N	21~30	Non-Ferrous Metals (Al)	-	-	-	-	-	-	-	-	-	-	-	-	-	-	350	1200	250	800
S	31~37	Superalloys & Titanium	-	-	-	-	-	-	35	80	-	-	30	90	20	40	20	40	-	-
H	38~41	Hard Materials	-	-	-	-	-	-	-	-	-	-	-	-	-	-	-	-	-	-

Turning Inserts - Negative

TNMG / TNMA (60° Negative)

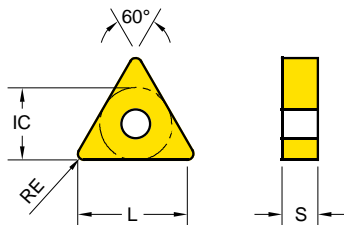

Series	L	IC	S
TN** 1604	15.7	9.53	4.76
TN** 2204	22	12.7	4.76

EDP 2200.. ● : Stock item ○ : Order made item

	Designation	RE	Fn (mm/rev.)	Ap (mm)	P05	P10	P20	P30	P20	M15	M30	M40	N20	N20
					K10	K20	M20	S10	S20	S30	N20	N20		
TNMA TNMG					YG1001	YG3010	YG3020	YG3030	YG801	YG211	YG213	YG214	YG100	YG10
	..MA				● 0035	● 0036								
	TNMA 160408	0.8	0.15~0.5	1~3										
	TNMA 160412	1.2	0.15~0.5	1.5~4										
-UF						● 0270	● 0271	● 0272	● 0039					
						● 0276	● 0277	● 0278						
						● 0721	● 0588							
						● 0407			● 0042					
	TNMG 160404 - UF	0.4	0.05~0.25	1~2										
	TNMG 160408 - UF	0.8	0.05~0.25	1.5~3.5										
	TNMG 160412 - UF	1.2	0.05~0.25	1.5~3.5										
	TNMG 220404 - UF	0.4	0.1~0.35	1~4										
-UL						● 0279	● 0280	● 0281						
							● 0621							
	TNMG 160408 - UL	0.8	0.1~0.3	1~3										
	TNMG 160412 - UL	1.2	0.1~0.3	1.5~3.5										
-UM						● 0282	● 0283	● 0284						
						● 0596	● 0597	● 0586	● 0710					
	TNMG 160408 - UM	0.8	0.15~0.3	0.5~2										
	TNMG 160412 - UM	1.2	0.15~0.3	1.5~3										

Cutting Speed			Vc (m/min.)																			
ISO	VDI	Sub Group	YG1001		YG3010		YG3020		YG3030		YG801		YG211		YG213		YG214		YG100		YG10	
			Min	Max	Min	Max	Min	Max	Min	Max	Min	Max	Min	Max	Min	Max	Min	Max	Min	Max	Min	Max
P	1-5	Non-Alloyed Steel	220	480	170	450	180	380	150	350	120	200	-	-	-	-	-	-	-	-	-	-
	6-9	Low-Alloyed Steel	220	420	180	380	110	350	90	300	70	200	-	-	-	-	-	-	-	-	-	-
	10-11	High-Alloyed Steel	-	-	100	330	60	300	70	250	-	-	-	-	-	-	-	-	-	-	-	-
M	12-13	Ferritic & Martensitic	-	-	-	-	-	-	120	230	-	-	130	230	110	180	80	150	-	-	-	-
	14	Austenitic Stainless Steel	-	-	-	-	-	-	80	200	-	-	100	200	40	130	30	120	-	-	-	-
K	15-16	Grey Cast Iron	170	420	120	300	-	-	-	-	-	-	-	-	-	-	-	-	-	-	-	-
	17-18	Nodular Cast Iron	120	410	120	280	-	-	-	-	-	-	-	-	-	-	-	-	-	-	-	-
N	21-30	Non-Ferrous Metals (Al)	-	-	-	-	-	-	-	-	-	-	-	-	-	-	-	350	1200	250	800	-
S	31-37	Superalloys & Titanium	-	-	-	-	-	-	35	80	-	-	30	90	20	40	20	40	-	-	-	-
H	38-41	Hard Materials	-	-	-	-	-	-	-	-	-	-	-	-	-	-	-	-	-	-	-	-

Turning Inserts - Negative TNMG / TNMA (60° Negative)

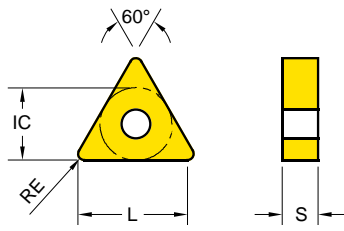

Series	L	IC	S
TN** 1604	15.7	9.53	4.76
TN** 2204	22	12.7	4.76

TURNING

PARTING & GROOVING



MILLING

DRILLING

TECHNICAL INFORMATION

EDP 2200..

● : Stock item ○ : Order made item

TNMA TNMG	Designation	RE	Fn (mm/rev.)	Ap (mm)	P05	P10	P20	P30	P20	M15	M30	M40	N20	N20
					K10	K20	M20	S10	S20	S30				
-UG  Medium Machining at Stable condition	TNMG 160404 - UG	0.4	0.2~0.4	0.5~2	●	●	●	●						
	TNMG 160408 - UG	0.8	0.2~0.4	1~3	●	●	●	●	●					
	TNMG 160412 - UG	1.2	0.2~0.4	1.5~3	●	●	●							
	TNMG 220408 - UG	0.8	0.25~0.6	1~4		●	●	●	●					
-UC  Cast iron and Medium roughing	TNMG 160404 - UC	0.4	0.2~0.4	0.5~2.5	●	●	●	●						
	TNMG 160408 - UC	0.8	0.2~0.4	1~3	●	●	●	●						
	TNMG 160412 - UC	1.2	0.2~0.4	1.5~3.5	●			●						
-UR  Roughing	TNMG 160408 - UR	0.8	0.30~0.50	1.0~5.0	●	●	●							
	TNMG 160412 - UR	1.2	0.3~0.5	1.5~3	●	●	●	●	●					
	TNMG 220412 - UR	1.2	0.30~0.65	1.5~4	●	●	●	●	●					
	TNMG 220416 - UR	1.6	0.3~0.65	2~4	●	●	●	●						

Cutting Speed			Vc (m/min.)																	
ISO	VDI	Sub Group	YG1001		YG3010		YG3020		YG3030		YG801		YG211		YG214		YG100		YG10	
			Min	Max	Min	Max	Min	Max	Min	Max	Min	Max	Min	Max	Min	Max	Min	Max	Min	Max
P	1~5	Non-Alloyed Steel	220	480	170	450	180	380	150	350	120	200	-	-	-	-	-	-	-	-
	6~9	Low-Alloyed Steel	220	420	180	380	110	350	90	300	70	200	-	-	-	-	-	-	-	-
	10~11	High-Alloyed Steel	-	-	100	330	60	300	70	250	-	-	-	-	-	-	-	-	-	-
M	12~13	Ferritic & Martensitic	-	-	-	-	-	-	120	230	-	-	130	230	110	180	80	150	-	-
	14	Austenitic Stainless Steel	-	-	-	-	-	-	80	200	-	-	100	200	40	130	30	120	-	-
K	15~16	Grey Cast Iron	170	420	120	300	-	-	-	-	-	-	-	-	-	-	-	-	-	
	17~18	Nodular Cast Iron	120	410	120	280	-	-	-	-	-	-	-	-	-	-	-	-	-	
N	21~30	Non-Ferrous Metals (Al)	-	-	-	-	-	-	-	-	-	-	-	-	-	-	350	1200	250	800
S	31~37	Superalloys & Titanium	-	-	-	-	-	-	35	80	-	-	30	90	20	40	20	40	-	-
H	38~41	Hard Materials	-	-	-	-	-	-	-	-	-	-	-	-	-	-	-	-	-	

Turning Inserts - Negative

TNMG / TNMA (60° Negative)

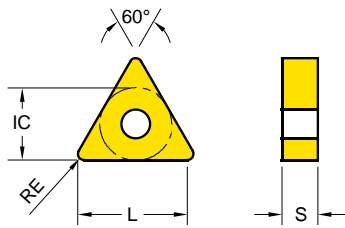

Series	L	IC	S
TN** 1604	15.7	9.53	4.76
TN** 2204	22	12.7	4.76

EDP 2200.. ● : Stock item ○ : Order made item

	TNMA TNMG	Designation	RE	Fn (mm/rev.)	Ap (mm)	EDP 2200..									
						YG1001	YG3010	YG3020	YG3030	YG801	YG211	YG213	YG214	YG100	YG10
-MF		TNMG 160404 - MF	0.4	0.05 ~ 0.3	0.2 ~ 1.5						●	●			
		TNMG 160408 - MF	0.8	0.05 ~ 0.3	0.15 ~ 1.5						●	●			
-MM		TNMG 160404 - MM	0.4	0.2 ~ 0.35	0.5 ~ 3						●	●			
		TNMG 160408 - MM	0.8	0.15 ~ 0.3	1 ~ 3.5						●	●			
		TNMG 160412 - MM	1.2	0.15 ~ 0.3	1.5 ~ 3.5						●	●			
-MR		TNMG 160408 - MR	0.8	0.30 ~ 0.55	2.0 ~ 5.5						●		●		
		TNMG 160412 - MR	1.2	0.30 ~ 0.55	2.0 ~ 5.5							●	●		

Cutting Speed			Vc (m/min.)																			
ISO	VDI	Sub Group	YG1001		YG3010		YG3020		YG3030		YG801		YG211		YG213		YG214		YG100		YG10	
			Min	Max	Min	Max	Min	Max	Min	Max	Min	Max	Min	Max	Min	Max	Min	Max	Min	Max	Min	Max
P	1-5	Non-Alloyed Steel	220	480	170	450	180	380	150	350	120	200	-	-	-	-	-	-	-	-	-	-
	6-9	Low-Alloyed Steel	220	420	180	380	110	350	90	300	70	200	-	-	-	-	-	-	-	-	-	-
	10-11	High-Alloyed Steel	-	-	100	330	60	300	70	250	-	-	-	-	-	-	-	-	-	-	-	-
M	12-13	Ferritic & Martensitic	-	-	-	-	-	-	120	230	-	-	130	230	110	180	80	150	-	-	-	-
	14	Austenitic Stainless Steel	-	-	-	-	-	-	80	200	-	-	100	200	40	130	30	120	-	-	-	-
K	15-16	Grey Cast Iron	170	420	120	300	-	-	-	-	-	-	-	-	-	-	-	-	-	-	-	-
	17-18	Nodular Cast Iron	120	410	120	280	-	-	-	-	-	-	-	-	-	-	-	-	-	-	-	-
N	21-30	Non-Ferrous Metals (Al)	-	-	-	-	-	-	-	-	-	-	-	-	-	-	-	350	1200	250	800	-
S	31-37	Superalloys & Titanium	-	-	-	-	-	-	35	80	-	-	30	90	20	40	20	40	-	-	-	-
H	38-41	Hard Materials	-	-	-	-	-	-	-	-	-	-	-	-	-	-	-	-	-	-	-	-

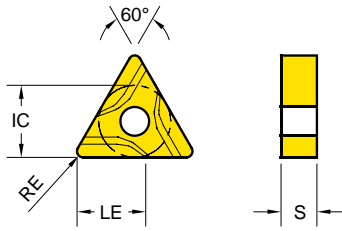

Turning Inserts - Negative TNUX (60° Negative)



Series	LE	IC	S
TN** 1604	9.4	9.53	4.76

EDP 2200..

● : Stock item ○ : Order made item



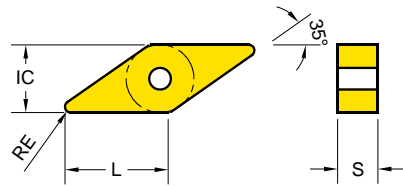

TNUX	Designation	RE	Fn (mm/rev.)	Ap (mm)	P05	P10	P30	P20	M15	M30	M40	N20	N20
					K10	K20	M20	S10	S20	S30			
..UX Left	 TNUX 160404 L	0.4	0.1 ~ 0.3	0.5 ~ 4		●	●		●				
		0.8	0.1 ~ 0.4	0.5 ~ 6		●	●	●	●	●			
	 TNUX 160404 R	0.4	0.1 ~ 0.3	0.5 ~ 4		●	●		●				
		0.8	0.1 ~ 0.4	0.5 ~ 6		●	●	●	●				

Cutting Speed			Vc (m/min.)																			
ISO	VDI	Sub Group	YG1001		YG3010		YG3020		YG3030		YG801		YG211		YG213		YG214		YG100		YG10	
			Min	Max	Min	Max	Min	Max	Min	Max	Min	Max	Min	Max	Min	Max	Min	Max	Min	Max	Min	Max
P	1-5	Non-Alloyed Steel	220	480	170	450	180	380	150	350	120	200	-	-	-	-	-	-	-	-	-	-
	6-9	Low-Alloyed Steel	220	420	180	380	110	350	90	300	70	200	-	-	-	-	-	-	-	-	-	-
	10-11	High-Alloyed Steel	-	-	100	330	60	300	70	250	-	-	-	-	-	-	-	-	-	-	-	-
M	12-13	Ferritic & Martensitic	-	-	-	-	-	-	120	230	-	-	130	230	110	180	80	150	-	-	-	-
	14	Austenitic Stainless Steel	-	-	-	-	-	-	80	200	-	-	100	200	40	130	30	120	-	-	-	-
K	15-16	Grey Cast Iron	170	420	120	300	-	-	-	-	-	-	-	-	-	-	-	-	-	-	-	-
	17-18	Nodular Cast Iron	120	410	120	280	-	-	-	-	-	-	-	-	-	-	-	-	-	-	-	-
N	21-30	Non-Ferrous Metals (Al)	-	-	-	-	-	-	-	-	-	-	-	-	-	-	-	350	1200	250	800	-
S	31-37	Superalloys & Titanium	-	-	-	-	-	-	35	80	-	-	30	90	20	40	20	40	-	-	-	-
H	38-41	Hard Materials	-	-	-	-	-	-	-	-	-	-	-	-	-	-	-	-	-	-	-	-

Turning Inserts - Negative VNMG / VNMA (35° Negative)



Series	L	IC	S
VN** 1604	15.8	9.53	4.76

		EDP 2200..												
		P05	P10	P20	P30	P20	M15	M30	M40	N20	N20			
		K10	K20	M20	S10	S20	S30	N20	N20					
		●	○	○	○	○	○	○	○	○	○			
VNMA VNMG	Designation	RE	Fn (mm/rev.)	Ap (mm)	YG1001	YG3010	YG3020	YG3030	YG801	YG211	YG213	YG214	YG100	YG10
..MA  Cast iron	VNMA 160408	0.8	0.15~0.5	1~3	● 0162									
-UF  Finishing	VNMG 160404 - UF	0.4	0.05~0.25	0.5~2		● 0306	● 0307	● 0308	● 0049					
	VNMG 160408 - UF	0.8	0.05~0.25	1~2.5		● 0309	● 0310	● 0311						
-UL  Medium Machining and sticky material	VNMG 160408 - UL	0.8	0.10~0.30	1~2.5		● 0428	● 0429							
-UM  Medium Machining Unstable condition	VNMG 160412 - UM	1.2	0.15~0.3	1.5~3		● 0736	● 0737							
-UG  Medium Machining at stable condition	VNMG 160408 - UG	0.8	0.2~0.4	1~3	● 0462	● 0312	● 0313	● 0314	● 0050					

Cutting Speed			Vc (m/min.)																			
ISO	VDI	Sub Group	YG1001		YG3010		YG3020		YG3030		YG801		YG211		YG213		YG214		YG100		YG10	
			Min	Max	Min	Max	Min	Max	Min	Max	Min	Max	Min	Max	Min	Max	Min	Max	Min	Max	Min	Max
P	1-5	Non-Alloyed Steel	220	480	170	450	180	380	150	350	120	200	-	-	-	-	-	-	-	-	-	-
	6-9	Low-Alloyed Steel	220	420	180	380	110	350	90	300	70	200	-	-	-	-	-	-	-	-	-	-
	10-11	High-Alloyed Steel	-	-	100	330	60	300	70	250	-	-	-	-	-	-	-	-	-	-	-	-
M	12-13	Ferritic & Martensitic	-	-	-	-	-	-	120	230	-	-	130	230	110	180	80	150	-	-	-	-
	14	Austenitic Stainless Steel	-	-	-	-	-	-	80	200	-	-	100	200	40	130	30	120	-	-	-	-
K	15-16	Grey Cast Iron	170	420	120	300	-	-	-	-	-	-	-	-	-	-	-	-	-	-	-	-
	17-18	Nodular Cast Iron	120	410	120	280	-	-	-	-	-	-	-	-	-	-	-	-	-	-	-	-
N	21-30	Non-Ferrous Metals (Al)	-	-	-	-	-	-	-	-	-	-	-	-	-	-	-	-	350	1200	250	800
S	31-37	Superalloys & Titanium	-	-	-	-	-	-	35	80	-	-	30	90	20	40	20	40	-	-	-	-
H	38-41	Hard Materials	-	-	-	-	-	-	-	-	-	-	-	-	-	-	-	-	-	-	-	-

Turning Inserts - Negative VNMG (35° Negative)

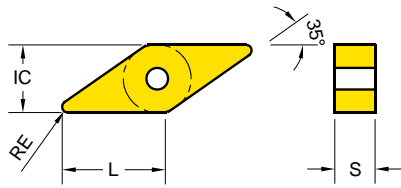

Series	L	IC	S
VN** 1604	15.8	9.53	4.76

TURNING

PARTING & GROOVING

MILLING

DRILLING

TECHNICAL INFORMATION

EDP 2200..

●: Stock item ○: Order made item

VNMG	Designation	RE	Fn (mm/rev.)	Ap (mm)	P05	P10	P20	P30	P20	M15	M30	M40	N20	N20
					K10	K20	M20	S10	S20	S30				
					YG1001	YG3010	YG3020	YG3030	YG801	YG211	YG213	YG214	YG100	YG10
-UC	VNMG 160404 - UC Cast iron and Medium roughing	0.4	0.2~0.4	0.5~2.5		● 0423								
	VNMG 160408 - UC	0.8	0.2~0.4	1~3	● 0094	● 0424	● 0425	● 0426						
-UR	VNMG 160412 - UR Roughing	1.2	0.3~0.5	1.2~3		● 0430	● 0431	● 0432	● 0051					
-MF	VNMG 160408 - MF Stainless steel Finishing	0.8	0.05~0.3	0.2~1.5				● 0830		● 0829				
-MM	VNMG 160404 - MM Stainless steel Medium	0.4	0.2~0.35	0.5~3.5						● 0661	● 0662			
	VNMG 160408 - MM	0.8	0.2~0.35	0.5~3.5						● 0663	● 0664			
-MR	VNMG 160408 - MR Stainless steel Roughing	0.8	0.30~0.55	2.0~5.5				● 0832			● 0831			

Cutting Speed			Vc (m/min.)																				
ISO	VDI	Sub Group	YG1001		YG3010		YG3020		YG3030		YG801		YG211		YG213		YG214		YG100		YG10		
			Min	Max	Min	Max	Min	Max	Min	Max	Min	Max	Min	Max	Min	Max	Min	Max	Min	Max	Min	Max	
P	1~5	Non-Alloyed Steel	220	480	170	450	180	380	150	350	120	200	-	-	-	-	-	-	-	-	-	-	-
	6~9	Low-Alloyed Steel	220	420	180	380	110	350	90	300	70	200	-	-	-	-	-	-	-	-	-	-	-
	10~11	High-Alloyed Steel	-	-	100	330	60	300	70	250	-	-	-	-	-	-	-	-	-	-	-	-	-
M	12~13	Ferritic & Martensitic	-	-	-	-	-	-	120	230	-	-	130	230	110	180	80	150	-	-	-	-	-
	14	Austenitic Stainless Steel	-	-	-	-	-	-	80	200	-	-	100	200	40	130	30	120	-	-	-	-	-
K	15~16	Grey Cast Iron	170	420	120	300	-	-	-	-	-	-	-	-	-	-	-	-	-	-	-	-	-
	17~18	Nodular Cast Iron	120	410	120	280	-	-	-	-	-	-	-	-	-	-	-	-	-	-	-	-	-
N	21~30	Non-Ferrous Metals (Al)	-	-	-	-	-	-	-	-	-	-	-	-	-	-	-	-	350	1200	250	800	-
S	31~37	Superalloys & Titanium	-	-	-	-	-	-	35	80	-	-	30	90	20	40	20	40	-	-	-	-	-
H	38~41	Hard Materials	-	-	-	-	-	-	-	-	-	-	-	-	-	-	-	-	-	-	-	-	-

Turning Inserts - Negative

WNMG / WNMA (80° Trigonal Negative)

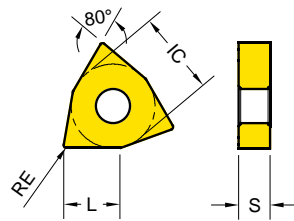

Series	L	IC	S
WN** 0604	5.7	9.53	4.76
WN** 0804	7.8	12.7	4.76

	Designation	RE	Fn (mm/rev.)	Ap (mm)	EDP 2200..																
					YG1001	YG3010	YG3015	YG3020	YG3030	YG801	YG211	YG213	YG214	YG100	YG10						
..MA Cast iron	WNMA 080404	0.4	0.15~0.5	0.5~2.5	●																
	WNMA 080408	0.8	0.15~0.5	1~3.5	●	●															
	WNMA 080412	1.2	0.15~0.5	1.5~5	●	●															
-UF Finishing	WNMG 060404 - UF	0.4	0.05~0.2	0.5~1.5		●		●	●	●											
	WNMG 080404 - UF	0.4	0.05~0.25	0.5~2		●		●	●	●											
	WNMG 080408 - UF	0.8	0.05~0.25	1~2.5		●		●	●	●											
-UL Light Machining and sticky material	WNMG 060408 - UL	0.8	0.1~0.3	1~2.5		●		●	●												
	WNMG 080408 - UL	0.8	0.1~0.3	1~3		●		●	●												
-UM Medium Machining at unstable condition	WNMG 060404 - UM	0.4	0.15~0.30	1.0~2.5		●		●	●												
	WNMG 060408 - UM	0.8	0.15~0.3	1~2		●		●	●												
	WNMG 080404 - UM	0.4	0.15~0.30	0.5~3.0		●		●	●												
	WNMG 080408 - UM	0.8	0.15~0.3	1~3	●	●		●	●												
	WNMG 080412 - UM	1.2	0.15~0.3	1.5~3				●	●												
	WNMG 080416 - UM	1.6	0.15~0.3	2~3.5				●	●												

Cutting Speed			Vc (m/min.)																			
ISO	VDI	Sub Group	YG1001		YG3010		YG3020		YG3030		YG801		YG211		YG213		YG214		YG100		YG10	
			Min	Max	Min	Max	Min	Max	Min	Max	Min	Max	Min	Max	Min	Max	Min	Max	Min	Max	Min	Max
P	1-5	Non-Alloyed Steel	220	480	170	450	180	380	150	350	120	200	-	-	-	-	-	-	-	-	-	-
	6-9	Low-Alloyed Steel	220	420	180	380	110	350	90	300	70	200	-	-	-	-	-	-	-	-	-	-
	10-11	High-Alloyed Steel	-	-	100	330	60	300	70	250	-	-	-	-	-	-	-	-	-	-	-	-
M	12-13	Ferritic & Martensitic	-	-	-	-	-	-	120	230	-	-	130	230	110	180	80	150	-	-	-	-
	14	Austenitic Stainless Steel	-	-	-	-	-	-	80	200	-	-	100	200	40	130	30	120	-	-	-	-
K	15-16	Grey Cast Iron	170	420	120	300	-	-	-	-	-	-	-	-	-	-	-	-	-	-	-	-
	17-18	Nodular Cast Iron	120	410	120	280	-	-	-	-	-	-	-	-	-	-	-	-	-	-	-	-
N	21-30	Non-Ferrous Metals (Al)	-	-	-	-	-	-	-	-	-	-	-	-	-	-	-	-	350	1200	250	800
S	31-37	Superalloys & Titanium	-	-	-	-	-	-	35	80	-	-	30	90	20	40	20	40	-	-	-	-
H	38-41	Hard Materials	-	-	-	-	-	-	-	-	-	-	-	-	-	-	-	-	-	-	-	-

Turning Inserts - Negative WNMG / WNMA (80° Trigonal Negative)

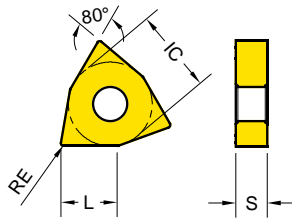

Series	L	IC	S
WN** 0604	5.7	9.53	4.76
WN** 0804	7.8	12.7	4.76

TURNING

PARTING & GROOVING

MILLING

DRILLING

TECHNICAL INFORMATION

WNMA WNMG	Designation	RE	Fn (mm/rev.)	Ap (mm)	EDP 2200..													
					YG1001	YG3010	YG3015	YG3020	YG3030	YG801	YG211	YG213	YG214	YG100	YG10			
-UG Medium Machining at stable condition	WNMG 060408 - UG	0.8	0.2~0.4	1~2.5	●			●		●								
	WNMG 080404 - UG	0.4	0.2~0.4	1.5~2.5		●		●	●									
	WNMG 080408 - UG	0.8	0.2~0.4	1~3.5	●	●	●	●	●	●								
	WNMG 080412 - UG	1.2	0.2~0.4	1.5~3.5	●	●		●										
	WNMG 080416 - UG	1.6	0.2~0.4	2~4				●										
-UC Cast iron and Medium roughing	WNMG 080404 - UC	0.4	0.25~0.4	0.5~3.5	●	●		●	●									
	WNMG 080408 - UC	0.8	0.2~0.4	1~4	●	●	●	●	●									
	WNMG 080412 - UC	1.2	0.2~0.4	1.5~4.5	●	●	●	●	●									
	WNMG 080416 - UC	1.6	0.20~0.40	2.0~4.0					●									
-UR Roughing	WNMG 080408 - UR	0.8	0.3~0.5	1.2~5	●	●		●	●									
	WNMG 080412 - UR	1.2	0.3~0.5	1.5~5	●	●	●	●	●	●								
	WNMG 080416 - UR	1.6	0.3~0.5	2~5	●	●		●	●									

* YG3015 = Vc 90~430 m/min

Cutting Speed			Vc (m/min.)																		
ISO	VDI	Sub Group	YG1001		YG3010		YG3020		YG3030		YG801		YG211		YG214		YG100		YG10		
			Min	Max	Min	Max	Min	Max	Min	Max	Min	Max	Min	Max	Min	Max	Min	Max	Min	Max	
P	1-5	Non-Alloyed Steel	220	480	170	450	180	380	150	350	120	200	-	-	-	-	-	-	-	-	-
	6-9	Low-Alloyed Steel	220	420	180	380	110	350	90	300	70	200	-	-	-	-	-	-	-	-	-
	10-11	High-Alloyed Steel	-	-	100	330	60	300	70	250	-	-	-	-	-	-	-	-	-	-	-
M	12-13	Ferritic & Martensitic	-	-	-	-	-	-	120	230	-	-	130	230	110	180	80	150	-	-	-
	14	Austenitic Stainless Steel	-	-	-	-	-	-	80	200	-	-	100	200	40	130	30	120	-	-	-
K	15-16	Grey Cast Iron	170	420	120	300	-	-	-	-	-	-	-	-	-	-	-	-	-	-	-
	17-18	Nodular Cast Iron	120	410	120	280	-	-	-	-	-	-	-	-	-	-	-	-	-	-	-
N	21-30	Non-Ferrous Metals (Al)	-	-	-	-	-	-	-	-	-	-	-	-	-	-	350	1200	250	800	-
S	31-37	Superalloys & Titanium	-	-	-	-	-	-	35	80	-	-	30	90	20	40	20	40	-	-	-
H	38-41	Hard Materials	-	-	-	-	-	-	-	-	-	-	-	-	-	-	-	-	-	-	-

Turning Inserts - Negative



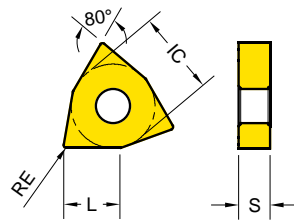

WNMG / WNMA (80° Trigonal Negative)



Series	L	IC	S
WN** 0604	5.7	9.53	4.76
WN** 0804	7.8	12.7	4.76

EDP 2200..

● : Stock item ○ : Order made item

WNMA WNMG	Designation	RE	Fn (mm/rev.)	Ap (mm)	P05	P10	P15	P20	P30	P20	M15	M30	M40	N20	N20
					K10	K20	M20	S10	S20	S30	N20	N20			
-MF 	WNMG 060404 - MF	0.4	0.07 ~ 0.30	0.2 ~ 1.5	●										
	WNMG 080404 - MF	0.4	0.07 ~ 0.3	0.15 ~ 1.5							●	●			
	WNMG 080408 - MF	0.8	0.07 ~ 0.3	0.2 ~ 1.5							●	●			
-MM 	WNMG 080404 - MM	0.4	0.2 ~ 0.35	0.5 ~ 3.5							●	●			
	WNMG 080408 - MM	0.8	0.2 ~ 0.35	1 ~ 3.5							●	●			
	WNMG 080412 - MM	1.2	0.2 ~ 0.35	1.5 ~ 3.5							●	●			
-MR 	WNMG 060412 - MR	1.2	0.2 ~ 0.5	1.2 ~ 4							●				
	WNMG 080408 - MR	0.8	0.30 ~ 0.55	2.0 ~ 5.5							●	●	●		
	WNMG 080412 - MR	1.2	0.30 ~ 0.55	2.0 ~ 5.5							●	●	●		
-KR 	WNMG 080408 - KR	0.8	0.30 ~ 0.60	1.0 ~ 5.0	●										
	WNMG 080412 - KR	1.2	0.30 ~ 0.60	1.5 ~ 5.0	●										

* YG3015 = Vc 90~430 m/min

Cutting Speed			Vc (m/min.)																			
ISO	VDI	Sub Group	YG1001		YG3010		YG3020		YG3030		YG801		YG211		YG213		YG214		YG100		YG10	
			Min	Max	Min	Max	Min	Max	Min	Max	Min	Max	Min	Max	Min	Max	Min	Max	Min	Max	Min	Max
P	1-5	Non-Alloyed Steel	220	480	170	450	180	380	150	350	120	200	-	-	-	-	-	-	-	-	-	-
	6-9	Low-Alloyed Steel	220	420	180	380	110	350	90	300	70	200	-	-	-	-	-	-	-	-	-	-
	10-11	High-Alloyed Steel	-	-	100	330	60	300	70	250	-	-	-	-	-	-	-	-	-	-	-	-
M	12-13	Ferritic & Martensitic	-	-	-	-	-	-	120	230	-	-	130	230	110	180	80	150	-	-	-	-
	14	Austenitic Stainless Steel	-	-	-	-	-	-	80	200	-	-	100	200	40	130	30	120	-	-	-	-
K	15-16	Grey Cast Iron	170	420	120	300	-	-	-	-	-	-	-	-	-	-	-	-	-	-	-	-
	17-18	Nodular Cast Iron	120	410	120	280	-	-	-	-	-	-	-	-	-	-	-	-	-	-	-	-
N	21-30	Non-Ferrous Metals (Al)	-	-	-	-	-	-	-	-	-	-	-	-	-	-	-	350	1200	250	800	-
S	31-37	Superalloys & Titanium	-	-	-	-	-	-	35	80	-	-	30	90	20	40	20	40	-	-	-	-
H	38-41	Hard Materials	-	-	-	-	-	-	-	-	-	-	-	-	-	-	-	-	-	-	-	-

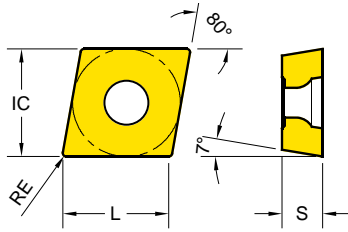

Turning Inserts - Positive CCMT / CCGT (80° Positive)



Series	L	IC	S
CC** 0602	6.2	6.35	2.38
CC** 09T3	9.2	9.53	3.97
CC** 1204	12.4	12.7	4.76

EDP 2200..

● : Stock item ○ : Order made item

CCGT CCMT	Designation	RE	Fn (mm/rev.)	Ap (mm)	P05	P10	P20	P30	P20	M15	M30	M40	N20	N20
					K10	K20	M20	S10	S20	S30	N20	N20		
-AL  Aluminum	CCGT 09T302 - AL	0.2	0.02 ~ 0.08	0.5 ~ 1	YG1001	YG3010	YG3020	YG3030	YG801	YG211	YG213	YG214	YG100	YG10
	CCGT 09T304 - AL	0.4	0.05 ~ 0.25	0.5 ~ 2									● 0339	● 0340
	CCGT 09T308 - AL	0.8	0.1 ~ 0.35	1 ~ 3									● 0081	● 0330
	CCGT 120402 - AL	0.2	0.04 ~ 0.15	0.1 ~ 1									● 0082	● 0331
	CCGT 120404 - AL	0.4	0.04 ~ 0.2	0.3 ~ 1.5									● 0473	● 0474
	CCGT 120408 - AL	0.8	0.04 ~ 0.2	0.6 ~ 2.5									● 0475	● 0476
-UF  Finishing	CCMT 060204 - UF	0.4	0.05 ~ 0.2	0.5 ~ 1.5		● 0163	● 0164	● 0165						
	CCMT 09T304 - UF	0.4	0.05 ~ 0.2	0.5 ~ 2		● 0169	● 0170							
-UG  General	CCMT 060204 - UG	0.4	0.1 ~ 0.25	0.5 ~ 2		● 0166	● 0167	● 0168	● 0006					
	CCMT 060208 - UG	0.8	0.1 ~ 0.25	0.8 ~ 2		● 0479	● 0683	● 0684	● 0009					
	CCMT 09T304 - UG	0.4	0.15 ~ 0.3	0.5 ~ 2		● 0172	● 0173	● 0174	● 0007					
	CCMT 09T308 - UG	0.8	0.15 ~ 0.3	0.8 ~ 2.5	● 0445	● 0150	● 0151	● 0152	● 0008					
	CCMT 120404 - UG	0.4	0.15 ~ 0.35	0.5 ~ 2.5		● 0175	● 0176							
	CCMT 120408 - UG	0.8	0.15 ~ 0.35	0.8 ~ 3.5		● 0153	● 0154	● 0155	● 0005					
	CCMT 120412 - UG	1.2	0.15 ~ 0.35	1.2 ~ 3.5		● 0483								

* YG3015 = Vc 90~430 m/min

Cutting Speed			Vc (m/min.)																			
ISO	VDI	Sub Group	YG1001		YG3010		YG3020		YG3030		YG801		YG211		YG213		YG214		YG100		YG10	
			Min	Max	Min	Max	Min	Max	Min	Max	Min	Max	Min	Max	Min	Max	Min	Max	Min	Max	Min	Max
P	1-5	Non-Alloyed Steel	220	480	170	450	180	380	150	350	120	200	-	-	-	-	-	-	-	-	-	-
	6-9	Low-Alloyed Steel	220	420	180	380	110	350	90	300	70	200	-	-	-	-	-	-	-	-	-	-
	10-11	High-Alloyed Steel	-	-	100	330	60	300	70	250	-	-	-	-	-	-	-	-	-	-	-	-
M	12-13	Ferritic & Martensitic	-	-	-	-	-	-	120	230	-	-	130	230	110	180	80	150	-	-	-	-
	14	Austenitic Stainless Steel	-	-	-	-	-	-	80	200	-	-	100	200	40	130	30	120	-	-	-	-
K	15-16	Grey Cast Iron	170	420	120	300	-	-	-	-	-	-	-	-	-	-	-	-	-	-	-	-
	17-18	Nodular Cast Iron	120	410	120	280	-	-	-	-	-	-	-	-	-	-	-	-	-	-	-	-
N	21-30	Non-Ferrous Metals (Al)	-	-	-	-	-	-	-	-	-	-	-	-	-	-	-	350	1200	250	800	
S	31-37	Superalloys & Titanium	-	-	-	-	-	-	35	80	-	-	30	90	20	40	20	40	-	-	-	-
H	38-41	Hard Materials	-	-	-	-	-	-	-	-	-	-	-	-	-	-	-	-	-	-	-	-

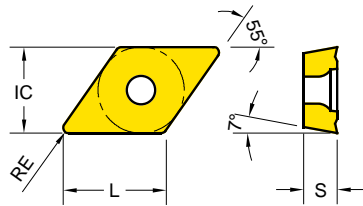

Turning Inserts - Positive

DCMT / DCGT (55° Positive)



Series	L	IC	S
DC** 0702	7.5	6.35	2.38
DC** 11T3	11.2	9.53	3.97

EDP 2200.. ● : Stock item ○ : Order made item

DCGT DCMT	Designation	RE	Fn (mm/rev.)	Ap (mm)	P05	P10	P30	P20	M15	M30	M40	N20	N20
					K10	K20	M20	S10	S20	S30			
-AL  Aluminum	DCGT 11T302 - AL	0.2	0.02~0.08	0.5~1								●	●
	DCGT 11T304 - AL	0.4	0.05~0.25	0.5~2								○	○
	DCGT 11T308 - AL	0.8	0.1~0.3	1~2.5								○	○
-UF  Finishing	DCMT 070204 - UF	0.4	0.05~0.2	0.5~1.5		●	●						
	DCMT 11T304 - UF	0.4	0.05~0.25	0.5~2		●	●						
	DCMT 11T308 - UF	0.8	0.05~0.25	1~2.5		●	●						
-UG  General	DCMT 070204 - UG	0.4	0.1~0.25	0.5~1.5		●	●		●				
	DCMT 070208 - UG	0.8	0.1~0.25	0.8~1.5		●	●						
	DCMT 11T304 - UG	0.4	0.15~0.3	0.5~2	●	●	●		●				
	DCMT 11T308 - UG	0.8	0.15~0.3	0.8~2.5	●	●	●	●	●				

Cutting Speed			Vc (m/min.)																			
ISO	VDI	Sub Group	YG1001		YG3010		YG3020		YG3030		YG801		YG211		YG213		YG214		YG100		YG10	
			Min	Max	Min	Max	Min	Max	Min	Max	Min	Max	Min	Max	Min	Max	Min	Max	Min	Max	Min	Max
P	1-5	Non-Alloyed Steel	220	480	170	450	180	380	150	350	120	200	-	-	-	-	-	-	-	-	-	-
	6-9	Low-Alloyed Steel	220	420	180	380	110	350	90	300	70	200	-	-	-	-	-	-	-	-	-	-
	10-11	High-Alloyed Steel	-	-	100	330	60	300	70	250	-	-	-	-	-	-	-	-	-	-	-	-
M	12-13	Ferritic & Martensitic	-	-	-	-	-	-	120	230	-	-	130	230	110	180	80	150	-	-	-	-
	14	Austenitic Stainless Steel	-	-	-	-	-	-	80	200	-	-	100	200	40	130	30	120	-	-	-	-
K	15-16	Grey Cast Iron	170	420	120	300	-	-	-	-	-	-	-	-	-	-	-	-	-	-	-	-
	17-18	Nodular Cast Iron	120	410	120	280	-	-	-	-	-	-	-	-	-	-	-	-	-	-	-	-
N	21-30	Non-Ferrous Metals (Al)	-	-	-	-	-	-	-	-	-	-	-	-	-	-	-	350	1200	250	800	-
S	31-37	Superalloys & Titanium	-	-	-	-	-	-	35	80	-	-	30	90	20	40	20	40	-	-	-	-
H	38-41	Hard Materials	-	-	-	-	-	-	-	-	-	-	-	-	-	-	-	-	-	-	-	-

Turning Inserts - Positive RCMT (Round Positive)

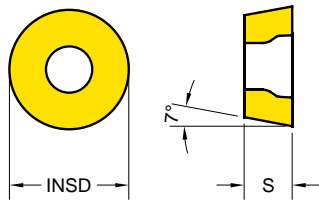

Series	INSD	S
RC** 0602	6	2.38
RC** 0803	8	3.18
RC** 10T3	10	3.97
RC** 1204	12	4.76

EDP 2200..

●: Stock item ○: Order made item

RCMT	Designation	RE	Fn (mm/rev.)	Ap (mm)	P05	P10	P20	P30	P20	M15	M30	M40	N20	N20
					K10	K20	M20	S10	S20	S30				
 General	RCMT 0602M0	3	0.05~0.25	0.2~1.2	●	●	●		●					
	RCMT 0803M0	4	0.05~0.3	0.5~1.5	●	●	●		●					
	RCMT 10T3M0	5	0.1~0.35	0.5~2.5	●	●	●		●					
	RCMT 1204M0	6	0.15~0.45	0.5~3	●	●	●		●					

Cutting Speed			Vc (m/min.)																	
ISO	VDI	Sub Group	YG1001		YG3010		YG3020		YG3030		YG801		YG211		YG214		YG100		YG10	
			Min	Max	Min	Max	Min	Max	Min	Max	Min	Max	Min	Max	Min	Max	Min	Max	Min	Max
P	1-5	Non-Alloyed Steel	220	480	170	450	180	380	150	350	120	200	-	-	-	-	-	-	-	-
	6-9	Low-Alloyed Steel	220	420	180	380	110	350	90	300	70	200	-	-	-	-	-	-	-	-
	10-11	High-Alloyed Steel	-	-	100	330	60	300	70	250	-	-	-	-	-	-	-	-	-	-
M	12-13	Ferritic & Martensitic	-	-	-	-	-	-	120	230	-	-	130	230	110	180	80	150	-	-
	14	Austenitic Stainless Steel	-	-	-	-	-	-	80	200	-	-	100	200	40	130	30	120	-	-
K	15-16	Grey Cast Iron	170	420	120	300	-	-	-	-	-	-	-	-	-	-	-	-	-	
	17-18	Nodular Cast Iron	120	410	120	280	-	-	-	-	-	-	-	-	-	-	-	-	-	
N	21-30	Non-Ferrous Metals (Al)	-	-	-	-	-	-	-	-	-	-	-	-	-	-	350	1200	250	800
S	31-37	Superalloys & Titanium	-	-	-	-	-	-	35	80	-	-	30	90	20	40	20	40	-	-
H	38-41	Hard Materials	-	-	-	-	-	-	-	-	-	-	-	-	-	-	-	-	-	

Turning Inserts - Positive

SCMT (Square Positive)

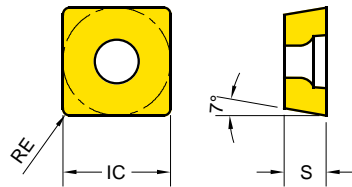

Series	IC	S
SC** 09T3	9.53	3.97
SC** 1204	12.7	4.76

EDP 2200..

● : Stock item ○ : Order made item

SCMT	Designation	RE	Fn (mm/rev.)	Ap (mm)	P05	P10	P20	P30	P20	M15	M30	M40	N20	N20
					K10	K20	M20	S10	S20	S30	N20	N20		
-UF Finishing	SCMT 09T304 - UF	0.4	0.05 ~ 0.25	0.5 ~ 2	●	●	●							
					YG1001	YG3010	YG3020	YG3030	YG801	YG211	YG213	YG214	YG100	YG10
-UG General	SCMT 09T304 - UG	0.4	0.15 ~ 0.3	1 ~ 2.5	●	●			●					
	SCMT 09T308 - UG	0.8	0.15 ~ 0.3	1 ~ 2.5	●	●	●		●					
	SCMT 120408 - UG	0.8	0.15 ~ 0.35	1 ~ 3.5	●	●	●	●						
					YG1001	YG3010	YG3020	YG3030	YG801	YG211	YG213	YG214	YG100	YG10

Cutting Speed			Vc (m/min.)																			
ISO	VDI	Sub Group	YG1001		YG3010		YG3020		YG3030		YG801		YG211		YG213		YG214		YG100		YG10	
			Min	Max	Min	Max	Min	Max	Min	Max	Min	Max	Min	Max	Min	Max	Min	Max	Min	Max	Min	Max
P	1-5	Non-Alloyed Steel	220	480	170	450	180	380	150	350	120	200	-	-	-	-	-	-	-	-	-	-
	6-9	Low-Alloyed Steel	220	420	180	380	110	350	90	300	70	200	-	-	-	-	-	-	-	-	-	-
	10-11	High-Alloyed Steel	-	-	100	330	60	300	70	250	-	-	-	-	-	-	-	-	-	-	-	-
M	12-13	Ferritic & Martensitic	-	-	-	-	-	-	120	230	-	-	130	230	110	180	80	150	-	-	-	-
	14	Austenitic Stainless Steel	-	-	-	-	-	-	80	200	-	-	100	200	40	130	30	120	-	-	-	-
K	15-16	Grey Cast Iron	170	420	120	300	-	-	-	-	-	-	-	-	-	-	-	-	-	-	-	-
	17-18	Nodular Cast Iron	120	410	120	280	-	-	-	-	-	-	-	-	-	-	-	-	-	-	-	-
N	21-30	Non-Ferrous Metals (Al)	-	-	-	-	-	-	-	-	-	-	-	-	-	-	-	350	1200	250	800	-
S	31-37	Superalloys & Titanium	-	-	-	-	-	-	35	80	-	-	30	90	20	40	20	40	-	-	-	-
H	38-41	Hard Materials	-	-	-	-	-	-	-	-	-	-	-	-	-	-	-	-	-	-	-	-

Turning Inserts - Positive TCMT / TCGT (Triangle Positive)

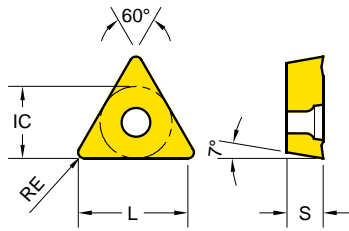

Series	L	IC	S
TC** 1102	10.3	6.35	2.38
TC** 16T3	15.6	9.53	3.97



TURNING

PARTING & GROOVING

MILLING

DRILLING

TECHNICAL INFORMATION

TCGT TCMT	Designation	RE	Fn (mm/rev.)	Ap (mm)	EDP 2200..										
					YG1001	YG3010	YG3020	YG3030	YG801	YG211	YG213	YG214	YG100	YG10	
-AL  Aluminum	TCGT 16T302 - AL	0.2	0.02 ~ 0.05	0.5 ~ 1										●	●
	TCGT 16T304 - AL	0.4	0.05 ~ 0.25	0.5 ~ 2										●	●
	TCGT 16T308 - AL	0.8	0.1 ~ 0.35	1 ~ 3										●	●
-UF  Finishing	TCMT 110204 - UF	0.4	0.05 ~ 0.2	0.5 ~ 2		●	●								
	TCMT 16T304 - UF	0.4	0.05 ~ 0.25	0.5 ~ 3		●	●		●						
	TCMT 16T308 - UF	0.8	0.05 ~ 0.25	0.8 ~ 3		●	●								
-UG  General	TCMT 110204 - UG	0.4	0.15 ~ 0.25	0.5 ~ 1.5	●				●						
	TCMT 110208 - UG	0.8	0.15 ~ 0.25	0.8 ~ 2		●	●								
	TCMT 16T304 - UG	0.4	0.15 ~ 0.3	0.5 ~ 2	●	●	●								
	TCMT 16T308 - UG	0.8	0.15 ~ 0.3	0.8 ~ 3	●	●	●	●	●						



Cutting Speed			Vc (m/min.)																			
ISO	VDI	Sub Group	YG1001		YG3010		YG3020		YG3030		YG801		YG211		YG213		YG214		YG100		YG10	
			Min	Max	Min	Max	Min	Max	Min	Max	Min	Max	Min	Max	Min	Max	Min	Max	Min	Max	Min	Max
P	1-5	Non-Alloyed Steel	220	480	170	450	180	380	150	350	120	200	-	-	-	-	-	-	-	-	-	-
	6-9	Low-Alloyed Steel	220	420	180	380	110	350	90	300	70	200	-	-	-	-	-	-	-	-	-	-
	10-11	High-Alloyed Steel	-	-	100	330	60	300	70	250	-	-	-	-	-	-	-	-	-	-	-	-
M	12-13	Ferritic & Martensitic	-	-	-	-	-	-	120	230	-	-	130	230	110	180	80	150	-	-	-	-
	14	Austenitic Stainless Steel	-	-	-	-	-	-	80	200	-	-	100	200	40	130	30	120	-	-	-	-
K	15-16	Grey Cast Iron	170	420	120	300	-	-	-	-	-	-	-	-	-	-	-	-	-	-	-	-
	17-18	Nodular Cast Iron	120	410	120	280	-	-	-	-	-	-	-	-	-	-	-	-	-	-	-	-
N	21-30	Non-Ferrous Metals (Al)	-	-	-	-	-	-	-	-	-	-	-	-	-	-	-	350	1200	250	800	-
S	31-37	Superalloys & Titanium	-	-	-	-	-	-	35	80	-	-	30	90	20	40	20	40	-	-	-	-
H	38-41	Hard Materials	-	-	-	-	-	-	-	-	-	-	-	-	-	-	-	-	-	-	-	-

Turning Inserts - Positive VBMT (35° Positive)

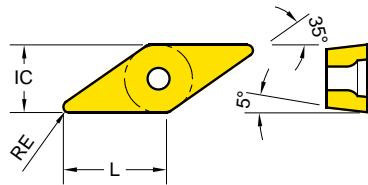
Series	L	IC	S
VB** 1604	15.8	9.53	4.76



EDP 2200.. ●: Stock item ○: Order made item

VBMT	Designation	RE	Fn (mm/rev.)	Ap (mm)	P05	P10	P20	P30	P20	M15	M30	M40	N20	N20
					K10	K20	M20	S10	S20	S30	N20	N20		
-UF  Finishing	VBMT 160404 - UF	0.4	0.05 ~ 0.25	0.5 ~ 2	●	●	●	●	●	●	●	●	●	●
	VBMT 160408 - UF	0.8	0.05 ~ 0.25	0.5 ~ 3	○	○	○	○	○	○	○	○	○	○
-UG  General	VBMT 160404 - UG	0.4	0.15 ~ 0.30	0.5 ~ 2.5	●	●	●	●	●	●	●	●	●	●
	VBMT 160408 - UG	0.8	0.2 ~ 0.4	1 ~ 3	○	○	○	○	○	○	○	○	○	○

Cutting Speed			Vc (m/min.)																			
ISO	VDI	Sub Group	YG1001		YG3010		YG3020		YG3030		YG801		YG211		YG213		YG214		YG100		YG10	
			Min	Max	Min	Max	Min	Max	Min	Max	Min	Max	Min	Max	Min	Max	Min	Max	Min	Max	Min	Max
P	1-5	Non-Alloyed Steel	220	480	170	450	180	380	150	350	120	200	-	-	-	-	-	-	-	-	-	-
	6-9	Low-Alloyed Steel	220	420	180	380	110	350	90	300	70	200	-	-	-	-	-	-	-	-	-	-
	10-11	High-Alloyed Steel	-	-	100	330	60	300	70	250	-	-	-	-	-	-	-	-	-	-	-	-
M	12-13	Ferritic & Martensitic	-	-	-	-	-	-	120	230	-	-	130	230	110	180	80	150	-	-	-	-
	14	Austenitic Stainless Steel	-	-	-	-	-	-	80	200	-	-	100	200	40	130	30	120	-	-	-	-
K	15-16	Grey Cast Iron	170	420	120	300	-	-	-	-	-	-	-	-	-	-	-	-	-	-	-	-
	17-18	Nodular Cast Iron	120	410	120	280	-	-	-	-	-	-	-	-	-	-	-	-	-	-	-	-
N	21-30	Non-Ferrous Metals (Al)	-	-	-	-	-	-	-	-	-	-	-	-	-	-	-	350	1200	250	800	-
S	31-37	Superalloys & Titanium	-	-	-	-	-	-	35	80	-	-	30	90	20	40	20	40	-	-	-	-
H	38-41	Hard Materials	-	-	-	-	-	-	-	-	-	-	-	-	-	-	-	-	-	-	-	-

Turning Inserts - Positive VCMT / VCGT (35° Positive)

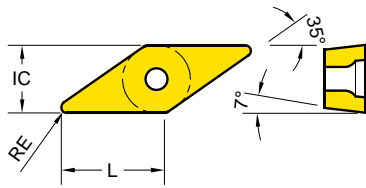

Series	L	IC	S
VC** 1604	15.8	9.53	4.76



TURNING

PARTING & GROOVING

MILLING

DRILLING

TECHNICAL INFORMATION

VCMT VCMT	Designation	RE	Fn (mm/rev.)	Ap (mm)	EDP 2200..											
					YG1001	YG3010	YG3020	YG3030	YG801	YG211	YG213	YG214	YG100	YG10		
-AL  Aluminum	VCMT 160402 - AL	0.2	0.02 ~ 0.05	0.5 ~ 1											●	●
	VCMT 160404 - AL	0.4	0.05 ~ 0.25	0.5 ~ 2											●	●
	VCMT 160408 - AL	0.8	0.1 ~ 0.35	1 ~ 3											●	●
-UF  Finishing	VCMT 160404 - UF	0.4	0.05 ~ 0.25	0.5 ~ 3		●	●									
	VCMT 160404 - UG	0.4	0.15 ~ 0.30	0.5 ~ 2.5						●						
-UG  General	VCMT 160408 - UG	0.8	0.15 ~ 0.30	1 ~ 3			●			●						

Cutting Speed			Vc (m/min.)																			
ISO	VDI	Sub Group	YG1001		YG3010		YG3020		YG3030		YG801		YG211		YG213		YG214		YG100		YG10	
			Min	Max	Min	Max	Min	Max	Min	Max	Min	Max	Min	Max	Min	Max	Min	Max	Min	Max	Min	Max
P	1-5	Non-Alloyed Steel	220	480	170	450	180	380	150	350	120	200	-	-	-	-	-	-	-	-	-	-
	6-9	Low-Alloyed Steel	220	420	180	380	110	350	90	300	70	200	-	-	-	-	-	-	-	-	-	-
	10-11	High-Alloyed Steel	-	-	100	330	60	300	70	250	-	-	-	-	-	-	-	-	-	-	-	-
M	12-13	Ferritic & Martensitic	-	-	-	-	-	-	120	230	-	-	130	230	110	180	80	150	-	-	-	-
	14	Austenitic Stainless Steel	-	-	-	-	-	-	80	200	-	-	100	200	40	130	30	120	-	-	-	-
K	15-16	Grey Cast Iron	170	420	120	300	-	-	-	-	-	-	-	-	-	-	-	-	-	-	-	-
	17-18	Nodular Cast Iron	120	410	120	280	-	-	-	-	-	-	-	-	-	-	-	-	-	-	-	-
N	21-30	Non-Ferrous Metals (Al)	-	-	-	-	-	-	-	-	-	-	-	-	-	-	-	-	350	1200	250	800
S	31-37	Superalloys & Titanium	-	-	-	-	-	-	35	80	-	-	30	90	20	40	20	40	-	-	-	-
H	38-41	Hard Materials	-	-	-	-	-	-	-	-	-	-	-	-	-	-	-	-	-	-	-	-



PARTING & GROOVING

Parting & Grooving Overview

Parting & Grooving Inserts (TD.)

Parting & Grooving Overview

Parting & Groove Turn Grades

Parting and Grooving Grades		P Steel				M Stainless steel			K Cast iron			N Non Ferrous		S Super Alloy		
		P10	P20	P30	P40	M10	M20	M30	K10	K20	K30	N10	N20	S10	S20	
PVD	YG602G (YG602)		602G				602G		602G						602G	

YG602G (YG602)

P20 - P35 M20 - M40
K20 - K40 S15 - S25

PVD - TiAlN

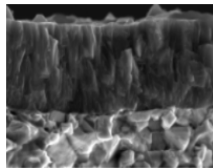





Universal grade for Parting & Groove Turn

- Ultra Dense PVD Coating with optimal thermal resistance & strength
- Sub-Micron substrate designed for demanding application
- YG602G : First Choice for Low Cutting Speed, Soft and Sticky Material with Low Hardness
- YG602 : First Choice for General Application

Parting & Grooving Inserts

	TD. Series	Inserts	2, 3, 4
		TDN TDP TDY	

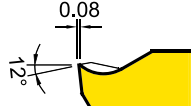
Parting & Grooving Chipbreakers

-P TDP			• Parting & Grooving (Positive)
-N TDN			• Parting & Grooving (General)
-Y TDY			• Side Turning

Parting & Grooving - Inserts

Parting & Grooving Inserts (TD.)

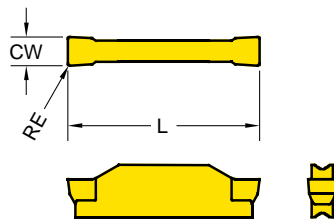

Series	L	CW
TD* 2	20	2
TD* 3	20	3
TD* 4	20	4

* CDX : Cutting Depth Maximum

● : Stock item ○ : Order made item

TD.	Designation	RE	Parting & Grooving		Side Turning		EDP 5200..	
			Fn (mm/rev.)	CDX (mm)	Fn (mm/rev.)	Ap (mm)	YG602	YG602G
TDP Parting & Grooving (Positive)	TDP2002	0.2	0.04~0.12	19			●	○
	TDP3002	0.2	0.05~0.16	19			●	○
	TDP4003	0.3	0.06~0.18	19			●	○
TDN Parting & Grooving (General)	TDN2002	0.2	0.06~0.18	19			●	○
	TDN3002	0.2	0.07~0.22	19			●	○
	TDN4003	0.3	0.08~0.25	19			●	○
TDY Groove Turn	TDY3E - 0.4	0.4	0.10~0.20	19	0.10~0.38	0.50~2.20	○	●
	TDY4E - 0.4	0.4	0.15~0.26	19	0.10~0.40	0.50~2.80		●

Cutting Speed			Vc (m/min.)	
ISO	VDI	Sub Group	YG602G (YG602)	
			Min.	Max.
P	1~5	Non-alloyed steel	90	180
	6~9	Low-alloyed steel	80	120
	10~11	High-alloyed steel	80	110
M	12~13	Ferritic & martensitic stainless steel	70	160
	14	Austenitic stainless steel	55	140
K	15~16	Grey cast iron	110	185
	17~18	Nodular cast iron	110	140
N	21~30	Non-ferrous metals (al)	250	440
S	31~37	Superalloys & Titanium	25	45
H	38~41	Hard materials	25	50



MILLING

Product Overview

Application Guide

Milling Inserts & Cutter Overview

Milling Inserts & Cutter

Code Keys - Milling Cutters

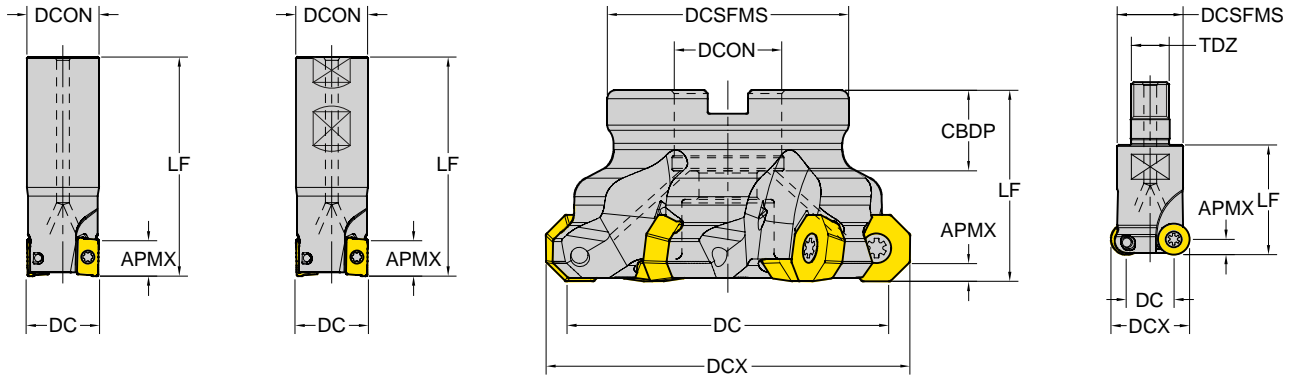

<C> Cylindrical

<W> Weldon

<S> Shell Mill

<M> Modular

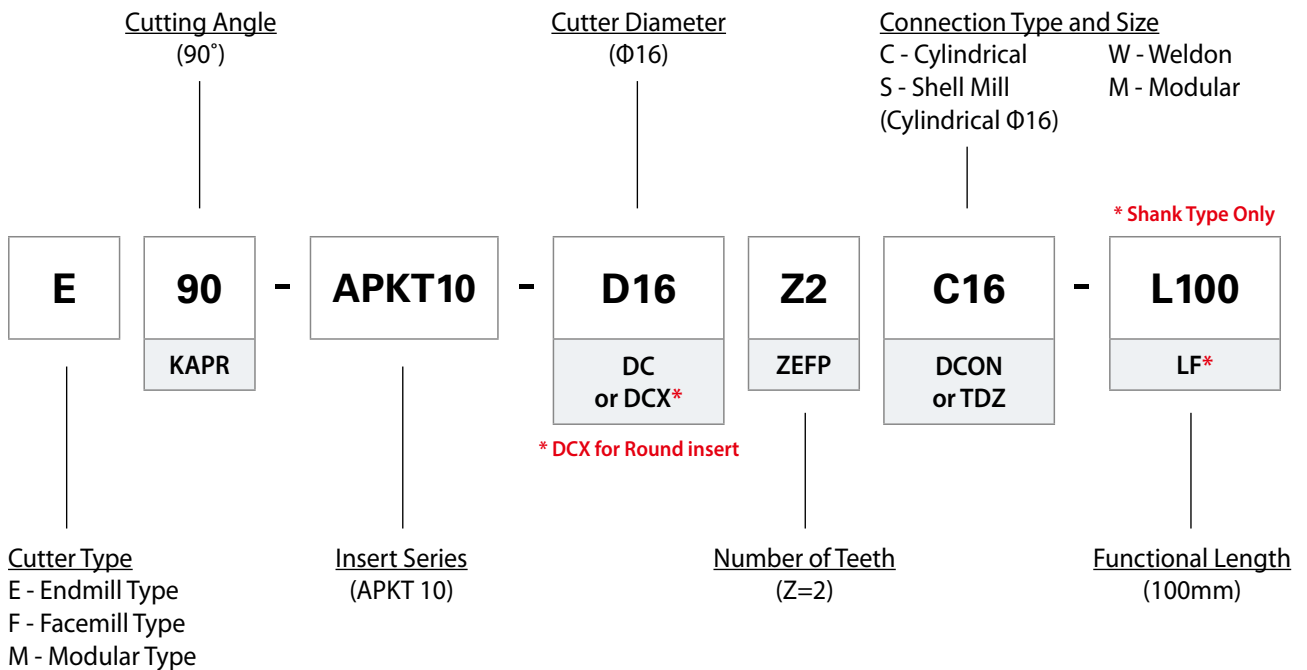

TURNING

PARTING & GROOVING

MILLING

DRILLING

TECHNICAL INFORMATION

Milling - Code System

Insert ISO Code System

TURNING

PARTING & GROOVING

MILLING

DRILLING

TECHNICAL INFORMATION

1 A Shape	2 P Relief Angle (AN)	3 K Tolerance	4 T Clamping & Chipbreaker	5 16 Insert Size	6 04 Insert Thickness (S)	7 08 CornerRadius
-------------------------------	--	-----------------------------------	---	---	--	---------------------------------------

1 - Shape

Symbol	Shape	
H	Hexagonal	
O	Octagonal	
P	Pentagonal	
S	Square	
T	Triangular	
V	Rhombic 35°	
W	Trigon	
L	Rectangular	
A	Parallelogram 80°	
R	Round	

2 - Relief Angle (AN)

Symbol	Relief Angle (AN)	
N	No Relief Angle	
B	Relief 5°	
C	Relief 7°	
P	Relief 11°	
D	Relief 15°	
E	Relief 20°	
F	Relief 25°	
O	Special	

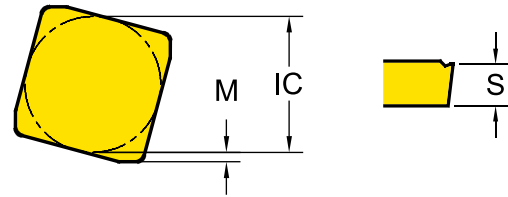

3 - Tolerance Class

Symbol	Inner Circle IC (mm)	Nose Height M (mm)	Thickness S (mm)
C	± 0.025	± 0.013	± 0.025
E	± 0.025	± 0.025	± 0.025
G	± 0.025	± 0.025	± 0.13
H	± 0.013	± 0.013	± 0.025
K*	± 0.05~0.15*	± 0.013	± 0.025
M*	± 0.05~0.15*	± 0.08~0.2*	± 0.13
U*	± 0.08~0.25*	± 0.13~0.38*	± 0.13

*Tolerance is different by insert IC size. Please see ISO 1832

4 - Clamping & Chipbreaker

Symbol	Clamping	Chipbreaker	Figure
N	No clamping hole	X	
R		One Face	
W	Screw Hole	X	
T		One Face	
U		Both Faces	
X	Special		

5 - Insert Size

* No Standard for milling insert size

6 - Insert Thickness

* No Standard for milling insert thickness

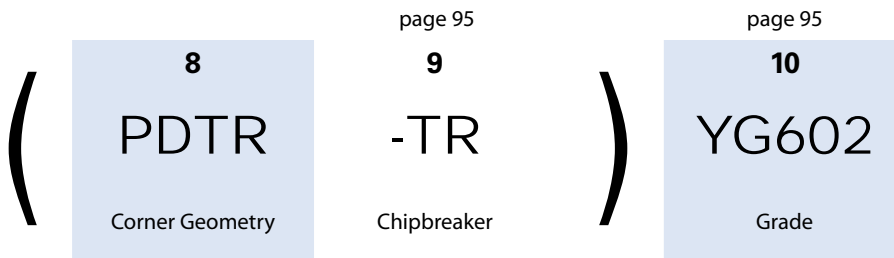

7 - Corner Radius (RE)

Symbol	Corner Radius - RE (mm)	Symbol	Corner Radius - RE (mm)
04	0.4	16	1.6
08	0.8	20	2.0
12	1.2	24	2.4

8 - Corner Geometry

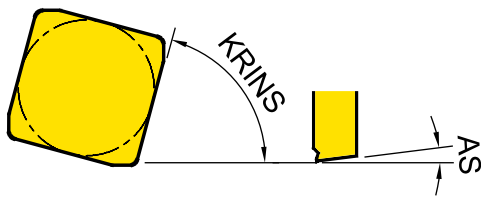

8-1	8-2	8-3	8-4
P	D	T	R
Cutting Edge Angle (KRINS)	Wiper Edge Clearance (AS)	Edge Condition	Feed Direction

*Refer to page. 95 for -AL, -ST, -TR... types

8-1 - Cutting Edge Angle (KRINS)

Symbol	Cutting Edge Angle (KRINS)
P	90°
A	45°
D	60°
E	75°
F	85°
Z	Special

8-3 - Edge Condition

Symbol	Edge Condition
F	Sharp
E	Rounded
T	Chamfered
S	Chamfered and Rounded

8-2 - Wiper Edge Clearance (AS)

Symbol	Wiper Edge Clearance (AS)
N	0°
P	11°
D	15°
E	20°
F	25°
Z	Special

8-4 - Feed Direction

Symbol	Feed Direction
R	Right-hand Insert
N	Neutral Insert
L	Left-hand Insert

Milling Overview

TURNING
PARTING & GROOVING
MILLING
DRILLING
TECHNICAL INFORMATION

Face Milling

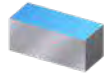

Negative Octagonal		Negative Square	
Cutter			
APMX	5.5	6	
DC	Φ63~315	Φ50~200	
page	p. 96	p. 97	
Positive Octagonal			
Cutter			
APMX	4	5	3
DC	Φ63~125	Φ63~160	Φ50~125
page	p. 98	p. 99	p. 98
Positive Square		ISO	
Cutter			
APMX	6	6	8
DC	Φ40~160	Φ50~160	Φ50~200
page	p. 100		p. 101

Shoulder Milling

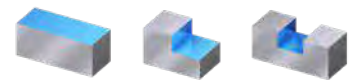

2 Corner Positive							
Cutter							
APMX	15	12	10	16	10	16	
DC	Φ25~125	Φ16~50	Φ16~100	Φ25~200	Φ16~80	Φ25~80	
page	p. 113	p. 113	p.114-115	p.116-117	p. 73	p. 73	
2 Corner Positive Helical (Long Edge)			ISO				
Cutter							
APMX	37~55	12	18				
DC	Φ25~40	Φ50~125	Φ63~315				
page	p. 119	p. 120					

Milling Overview

Profiling

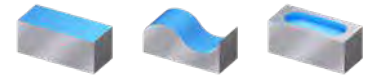

Round Positive										
Cutter		 RDKT/RDKW			 RPMT/RPMW					
APMX		0802	10T3	1204	08T2	10T3	1204			
DC		4	5	6	4	5	6			
page		Φ16~25	Φ20~63	Φ25~100	Φ20~25	Φ25~32	Φ32~80			
		p. 126	p. 126	p. 127	p. 128	p. 128	p. 128			

High Feed Milling

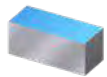

Positive 4 Corner	
Cutter	 SDMT/SDMW 1204
APMX	6
DC	Φ50~200
page	p. 133

Taper Milling





2 Corner Positive Helical (Long Edge)	
Cutter	 APKT 1604
KAPR	15° 45° 60° 75°
page	p. 135

Modular Shank

Modular Shank for Modular Head	
Cutter	 M08 ~ M16
page	p. 137

Milling Inserts Overview

A 2 Corner	 Positive	ADKT	ADKT 1505	p. 121
		AOMT	AOMT 1236	p. 121
		APKT	APKT 1003, 1604	p. 122
		APMT	APMT 1135, 1504, 1604,	p. 123
O Octagon	 Positive	ODMT	ODMT / ODMW 0605	p. 102
		OFER	OFER 0704	p. 103
	OFMT	OFMT 05T3		
 Negative	ONMU / ONHU	ONMU / ONHU 0806	p. 104	
R Round	 Positive Round	RDKT / RDKW	RDKT 0802, 10T3, 1204 RDKW 0501, 0702, 0802, 10T3, 1204	p. 129
		RDMT	RDMT 0802, 0803, 10T3, 1204 RDMW 0802, 10T3, 1204	p. 130
	 Positive 3 Corner	RPMT / RPMW	RPMT 08T2, 10T3, 1204 RPMW 1003, 1204	p. 131
		RBEX50	RBEX50	P. 132
S Square	 High Feed	SDMT / SDMW	SDMT 1204, SDMW 1204	p. 134
		SEKT	SEKT 12T3, 1204	p. 107
	 Positive	SEMT	SEMT1204, 13T3	P. 108
		SPMT	SPMT 1204	p. 111
		SDKN (45°)	SDKN 1203, 1504	p. 105
	 ISO	SEKN / SEKR (45°)	SEKN 1203 / SEKR 1203	p. 106
		SPKN/SPKR (75°)	SPKN 1203, 1504 SPKR 1203 SPCN 1203, 1504	p. 110
		SPUN	SPUN 1203	
 Negative	SNMX	SNMX1206	p. 109	
T Triangle	 ISO	TPKN / TPKR / TPCN(90°)	TPKN 1603, 2204 TPKR 1603, 2204 TPCN 2204	p. 124
		TPUN	TPUN 160308	p. 125

Milling Grades and Chipbreakers

Milling Grades

Milling Grades	P Steel				M Stainless Steel				K Cast Iron				N Non Ferrous				S Super Alloy				
	P05	P15	P25	P35	M05	M15	M25	M35	K05	K15	K25	K35	N05	N15	N25	N35	S05	S15	S25	S35	
PVD	YG602			602				602			602								602		
	YG622			622							622										
	YG712			712																	

<p>YG602</p> <p>P20 - P35 M20 - M40</p> <p>K20 - K40 S15 - S25</p>	<p>PVD - TiAlN</p>	<p>Universal grade for General Milling Application</p> <ul style="list-style-type: none"> • Ultra Dense PVD Coating with optimal thermal resistance & strength • Sub-Micron substrate designed for demanding application
<p>YG622</p> <p>P20 - P40</p> <p>K20 - K40</p>	<p>PVD - TiAlN</p>	<p>Optimized Grade for High Alloyed or Prehardened Steel</p> <p>Excellent hot hardness and oxidation resistance at high speed</p>
<p>YG712</p> <p>P10 - P30</p>	<p>PVD - AlTiCrN</p>	<p>General Milling Grade for Steel</p>

Milling Chipbreakers

-AL		<ul style="list-style-type: none"> • For Aluminum • Very Sharp Geometry
-ST		<ul style="list-style-type: none"> • For Stainless Steel, Super Alloy • Sharp Geometry
General Inserts (No Description)		<ul style="list-style-type: none"> • First Choice for General Application
-TR		<ul style="list-style-type: none"> • For Hardened Steels • Reinforced Geometry
...W / ...N		<ul style="list-style-type: none"> • For Hardened Material and Cast Irons

Milling - Face Milling - Cutter

Cutters for ONMU

Cutting Angle : 45°
16 Corner Negative

TURNING

PARTING & GROOVING

MILLING

DRILLING

TECHNICAL INFORMATION

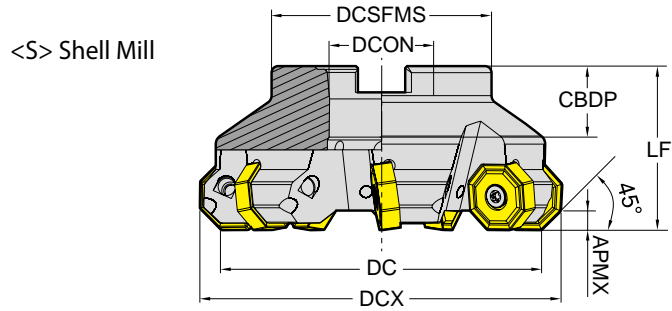

ZEFP : Effective Number of Cutting Edges
CICT : Number of Inserts
CDBP : Connection Bore Depth

: p. 104 unit:mm

Series	APMX	Designation	EDP 1700..	DC	DCX	ZEFP	LF	TYPE	DCON	CBDP	DCSFMS	PCD1	PCD2	
ONMU 0806	5.5	F45 - ONMU08 - D63Z5S22	0493	63	75	5	40	Shellmill	22	22	49	-	-	●
		F45 - ONMU08 - D80Z6S27	0494	80	92	6	50		27	25	58	-	-	●
		F45 - ONMU08 - D100Z7S32	0495	100	112	7	50		32	26	67	-	-	●
		F45 - ONMU08 - D125Z8S40 - WOC	0496	125	137	8	63		40	32	87	-	-	X
		F45 - ONMU08 - D160Z10S40 - WOC	0497	160	172	10	63		40	32	107	66.7	-	X
		F45 - ONMU08 - D200Z12S60 - WOC	0498	200	212	12	63		60	40	130	101.6	-	X
		F45 - ONMU08 - D315Z16S60 - WOC	0499	315	327	16	63		60	40	220	101.6	177.8	X

▶ ONHU is Available for Wiper Insert

Milling - Face Milling - Cutter

Cutters for SNMX

Cutting Angle : 45°
8 Corner Negative

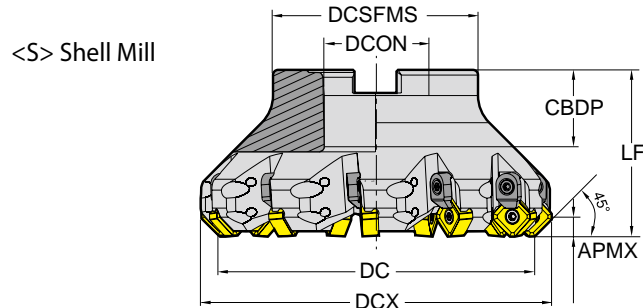

ZAFP : Effective Number of Cutting Edges
CICT : Number of Inserts
CBDP : Connection Bore Depth

: p.109 unit:mm

Series	APMX	Designation	EDP 1700..	DC	DCX	ZAFP	LF	TYPE	DCON	CBDP	DCSFMS	PCD1	PCD2	
SNMX 1206	6.0	F45 - SNMX12 - D50Z4S22	0506	50	63	4	42	Shellmill	22	22	42	-	-	●
		F45 - SNMX12 - D50Z5S22	0507	50	63	5	42		22	22	42	-	-	●
		F45 - SNMX12 - D63Z6S22	0508	63	76	6	42		22	22	48	-	-	●
		F45 - SNMX12 - D63Z7S22	0509	63	76	7	42		22	22	48	-	-	●
		F45 - SNMX12 - D80Z7S27	0510	80	93	7	52		27	25	58	-	-	●
		F45 - SNMX12 - D80Z8S27	0511	80	93	8	52		27	25	58	-	-	●
		F45 - SNMX12 - D100Z10S32	0512	100	113	10	52		32	26	67	-	-	●
		F45 - SNMX12 - D100Z8S32	0513	100	113	8	52		32	26	67	-	-	●
		F45 - SNMX12 - D125Z11S40 - WOC	0514	125	138	11	65		40	32	80	-	-	X
		F45 - SNMX12 - D160Z12S40 - WOC	0515	160	173	12	65		40	32	110	66.7	-	X
F45 - SNMX12 - D200Z14S60 - WOC	0516	200	213	14	65	60	40	130	101.6	-	X			

Milling - Face Milling - Cutter

Cutters for OFER

Cutting Angle : 43°
8 Corner Positive

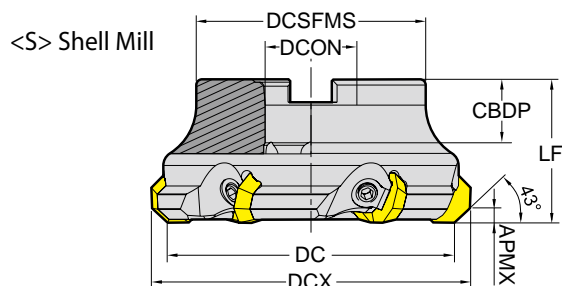

ZEFP : Effective Number of Cutting Edges
CICT : Number of Inserts
CBDP : Connection Bore Depth

: p. 103 unit:mm

Series	APMX	Designation	EDP 1700..	DC	DCX	ZEFP	LF	TYPE	DCON	CBDP	DCSFMS	PCD1	PCD2	
OFER 0704	5.0	F43 - OFER07 - D63Z4S22 - WOC	0484	63	75	4	45	Shellmill	22	22	48	-	-	X
		F43 - OFER07 - D80Z5S27 - WOC	0485	80	92	5	50		27	25	58	-	-	X
		F43 - OFER07 - D100Z6S32 - WOC	0486	100	112	6	50		32	26	80	-	-	X
		F43 - OFER07 - D125Z8S40 - WOC	0487	125	137	8	63		40	32	85	-	-	X
		F43 - OFER07 - D160Z9S40 - WOC	0488	160	172	9	63		40	32	110	66.7	-	X

Milling - Face Milling - Cutter

Cutters for ODMT, ODMW, OFMT

CUTTING ANGLE : 43°

8 Corner Positive

<S> Shell Mill

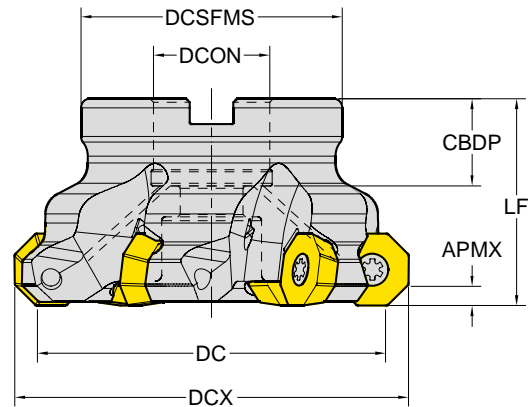

□: p.102 unit:mm

ZAFP : Effective Number of Cutting Edges
CICT : Number of Inserts
CBDP : Connection Bore Depth

Series	APMX	Designation	EDP 1700..	DC	DCX	ZAFP	LF	TYPE	DCON	CBDP	DCSFMS	PCD1	PCD2	☉
ODMT ODMW 0605	3.5	F43 - ODMT06 - D63Z5S22	0001	63	73	5	40	Shellmill	22	20	50	-	-	●
		F43 - ODMT06 - D80Z6S27	0002	80	90	6	50		27	23	56	-	-	●
		F43 - ODMT06 - D100Z7S32	0003	100	110	7	50		32	26	78	-	-	●
		F43 - ODMT06 - D125Z8S40	0004	125	135	8	63		40	28	89	-	-	●

CUTTING ANGLE : 43°

8 Corner Positive

<S> Shell Mill

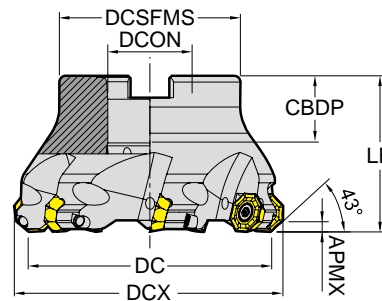

□: p.103 unit:mm

Series	APMX	Designation	EDP 1700..	DC	DCX	ZAFP	LF	TYPE	DCON	CBDP	DCSFMS	PCD1	PCD2	☉
OFMT 05T3	3.0	F43 - OFMT05 - D50Z5S22	0489	50	58	5	40	Shellmill	22	22	42	-	-	●
		F43 - OFMT05 - D63Z6S22	0490	63	71	6	40		22	22	48	-	-	●
		F43 - OFMT05 - D80Z7S27	0491	80	88	7	50		27	25	58	-	-	●
		F43 - OFMT05 - D125Z9S40 - WOC	0492	125	133	9	63		40	32	85	-	-	X

Milling - Face Milling - Cutter

Cutters for SEKT

Cutting Angle : 45°
4 Corner Positive

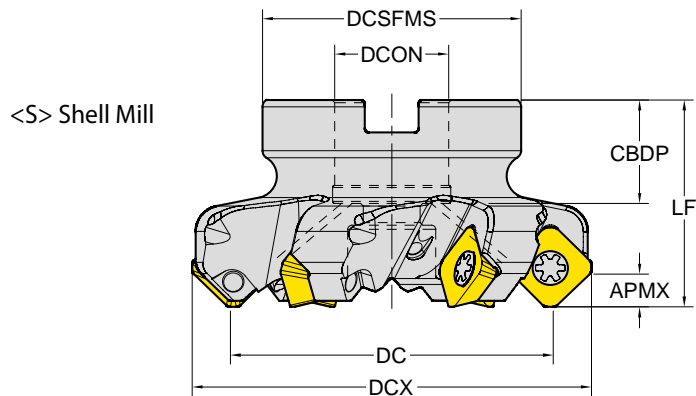

ZEFP : Effective Number of Cutting Edges
CICT : Number of Inserts
CBDP : Connection Bore Depth

□ : p. 107 unit:mm

Series	APMX	Designation	EDP 1700..	DC	DCX	ZEFP	LF	TYPE	DCON	CBDP	DCSFMS	PCD1	PCD2	☉
SEKT 12T3	6.0	F45 - SE12T3 - D50Z4S22	0500	50	63	4	40	Shellmill	22	22	48	-	-	●
		F45 - SE12T3 - D63Z5S22	0501	63	76	5	40		22	22	48	-	-	●
		F45 - SE12T3 - D80Z6S27	0502	80	93	6	50		27	25	58	-	-	●
		F45 - SE12T3 - D100Z7S32	0503	100	113	7	50		32	26	65	-	-	●
		F45 - SE12T3 - D125Z8S40 - WOC	0504	125	138	8	63		40	32	85	-	-	X
		F45 - SE12T3 - D160Z10S40 - WOC	0505	160	173	10	63		40	32	110	66.7	-	X
SEKT 1204	6.0	F45 - SEKT12 - D40Z4S16	0031	40	54	4	40	Shellmill	16	18	32	-	-	●
		F45 - SEKT12 - D50Z5S22	0032	50	64	5	40		22	20	48	-	-	●
		F45 - SEKT12 - D63Z4S22	0033	63	77	4	40		22	20	50	-	-	●
		F45 - SEKT12 - D63Z6S22	0034	63	77	6	40		22	20	50	-	-	●
		F45 - SEKT12 - D80Z4S27	0035	80	94	4	50		27	22	56	-	-	●
		F45 - SEKT12 - D80Z7S27	0036	80	94	7	50		27	22	56	-	-	●
		F45 - SEKT12 - D100Z8S32	0037	100	114	8	50		32	25	78	-	-	●
		F45 - SEKT12 - D125Z10S40	0038	125	139	10	63		40	29	90	-	-	●
		F45 - SEKT12 - D160Z12S40	0039	160	174	12	63		40	30	114	-	-	X

Milling - Face Milling - Cutter

Cutters for SPKN, SPKR, SPCN

Cutting Angle : 75°
4 Corner Positive ISO

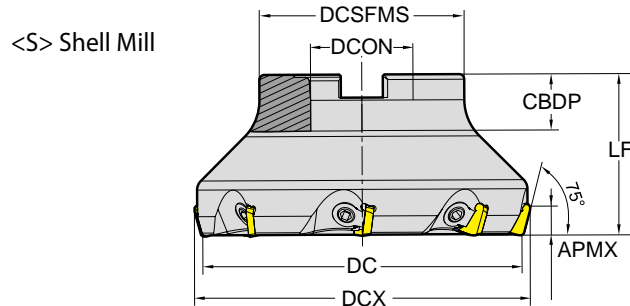

ZAFP : Effective Number of Cutting Edges
CICT : Number of Inserts
CBDP : Connection Bore Depth

: p.110 unit:mm

Series	APMX	Designation	EDP 1700..	DC	DCX	ZAFP	LF	TYPE	DCON	CBDP	DCSFMS	PCD1	PCD2	
SPKN SPKR SPCN 1203	8.0	F75 - SPKN12 - D50Z4S22 - WOC	0611	50	56	4	40	Shellmill	22	22	42	-	-	X
		F75 - SPKN12 - D63Z5S22 - WOC	0612	63	69	5	40		22	22	48	-	-	X
		F75 - SPKN12 - D80Z6S27 - WOC	0613	80	86	6	50		27	25	58	-	-	X
		F75 - SPKN12 - D100Z7S32 - WOC	0614	100	106	7	50		32	26	65	-	-	X
		F75 - SPKN12 - D125Z8S40 - WOC	0615	125	131	8	63		40	32	80	-	-	X
		F75 - SPKN12 - D160Z9S40 - WOC	0616	160	166	9	63		40	32	110	66.7	-	X
		F75 - SPKN12 - D200Z12S60 - WOC	0617	200	206	12	63		60	40	130	101.6	-	X

Milling - Face Milling - Inserts

ODMT, ODMW - Face Milling Positive (8 Corners)

Series	IC	S
ODM* 0605	15.9	5.6

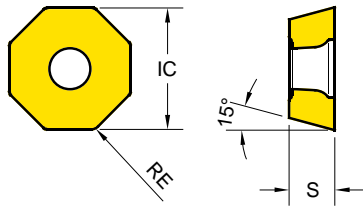

EDP 1200..

P25	P30	P20
M30		
K30	K30	
S20		

● : Stock item
○ : Order made item

ODMT ODMW	Designation	RE (mm)	Fz (mm/tooth)	BS (mm)	YG602	YG622	YG712
ODMT General	ODMT 060508	0.8	0.21 ~ 0.35		● 0030		
ODMW Hard Materials	ODMW 060508	0.8	0.26 ~ 0.40		● 0031		

Cutting Speed			Vc (m/min.)					
ISO	VDI	Sub Group	YG602		YG622		YG712	
			Min	Max	Min	Max	Min	Max
P	1-5	Non-Alloyed Steel	140	380	140	400	170	300
	6-9	Low-Alloyed Steel	120	300	120	320	180	250
	10-11	High-Alloyed Steel	70	150	70	170	100	140
M	12-13	Ferritic & Martensitic	120	200	-	-	-	-
	14	Austenitic Stainless Steel	130	250	-	-	-	-
K	15-16	Grey Cast Iron	120	250	120	270	-	-
	17-18	Nodular Cast Iron	130	220	130	240	-	-
N	21-30	Non-Ferrous Metals (Al)	-	-	-	-	-	-
S	31-37	Superalloys & Titanium	25	45	-	-	-	-
H	38-41	Hard Materials	40	80	40	100	-	-

Milling - Face Milling - Inserts

OFER, OFMT - Face Milling Positive (8 Corners)

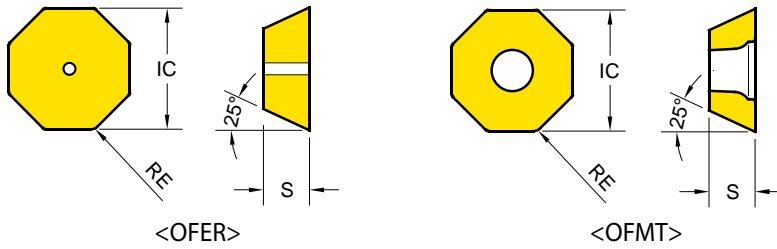

Series	IC	S
OFER 0704	18.05	4.78
OFMT 05T3	12.73	4.06

EDP 1200..

P25	P30	P20
M30		
K30	K30	
S20		

● : Stock item
○ : Order made item

OFER	Designation	RE (mm)	Fz (mm/tooth)	BS (mm)	EDP 1200..		
					YG602	YG622	YG712
	OFER 070405	0.5	0.22 ~ 0.50		● 0209		

OFER
General



OFMT	Designation	RE (mm)	Fz (mm/tooth)	BS (mm)	EDP 1200..		
					YG602	YG622	YG712
	OFMT 05T308	0.8	0.15 ~ 0.25		● 0032		

OFMT
General



Cutting Speed			Vc (m/min.)					
ISO	VDI	Sub Group	YG602		YG622		YG712	
			Min	Max	Min	Max	Min	Max
P	1-5	Non-Alloyed Steel	140	380	140	400	170	300
	6-9	Low-Alloyed Steel	120	300	120	320	180	250
	10-11	High-Alloyed Steel	70	150	70	170	100	140
M	12-13	Ferritic & Martensitic	120	200	-	-	-	-
	14	Austenitic Stainless Steel	130	250	-	-	-	-
K	15-16	Grey Cast Iron	120	250	120	270	-	-
	17-18	Nodular Cast Iron	130	220	130	240	-	-
N	21-30	Non-Ferrous Metals (Al)	-	-	-	-	-	-
S	31-37	Superalloys & Titanium	25	45	-	-	-	-
H	38-41	Hard Materials	40	80	40	100	-	-

Milling - Face Milling - Inserts

ONMU / ONHU - Face Milling Negative (16 Corners)

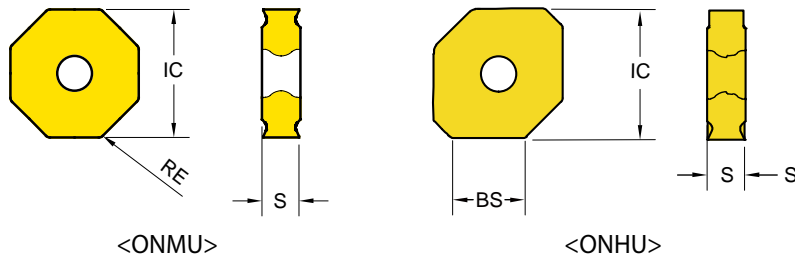



Series	IC	S
ONMU 0806	20.2	5.8
ONHU 0806	20.2	5.9

EDP 1200..

P25	P30	P20
M30		
K30	K30	K15
S20		

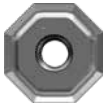
●: Stock item
○: Order made item

ONMU	Designation	RE (mm)	Fz (mm/tooth)	BS (mm)	YG602	YG622	YG712	YG5020
	ONMU 080608	0.8	0.22 ~ 0.50		● 0233			● 0414
ONMU General								
	ONHU 080612		0.22 ~ 0.50	10.6				● 0482
ONHU Wiper Insert								

Cutting Speed			Vc (m/min.)							
ISO	VDI	Sub Group	YG602		YG622		YG712		YG5020	
			Min	Max	Min	Max	Min	Max	Min	Max
P	1-5	Non-Alloyed Steel	140	380	140	400	170	300	-	-
	6-9	Low-Alloyed Steel	120	300	120	320	180	250	-	-
	10-11	High-Alloyed Steel	70	150	70	170	100	140	-	-
M	12-13	Ferritic & Martensitic	120	200	-	-	-	-	-	-
	14	Austenitic Stainless Steel	130	250	-	-	-	-	-	-
K	15-16	Grey Cast Iron	120	250	120	270	-	-	200	350
	17-18	Nodular Cast Iron	130	220	130	240	-	-	150	300
N	21-30	Non-Ferrous Metals (Al)	-	-	-	-	-	-	-	-
S	31-37	Superalloys & Titanium	25	45	-	-	-	-	-	-
H	38-41	Hard Materials	40	80	40	100	-	-	-	-

Milling - Face Milling - Inserts

SDKN / CN - Face Milling Positive (4 Corners ISO)

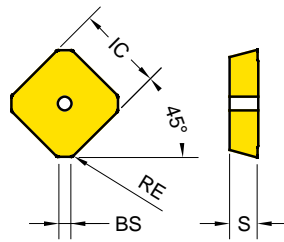

Series	AS	IC	S
SD** 1203	15°	12.7	3.1
SD** 1504	15°	15.88	4.7

EDP 1200..

P25	P30	P20
M30		
K30	K30	
S20		

● : Stock item
○ : Order made item

SDKN SDCN	Designation	RE (mm)	Fz (mm/tooth)	BS (mm)	EDP 1200..		
					YG602	YG622	YG712
SDKN Hard Materials	SDKN 1203 AETN	0.5	0.22 ~ 0.35	1.85	● 0058		
	SDKN 1504 AETN	0.45	0.22 ~ 0.40	2	● 0059		
	SDKN 1203 AETN - PW	0.4	0.22 ~ 0.35	1.98	● 0253		
	SDKN 1504 AETN - PW	0.4	0.22 ~ 0.40	1.95	● 0288		
	SDKN 1203 AETN - GW	1.3	0.2 ~ 0.4	1.85	● 0251		
	SDKN 1504 AETN - GW	1.3	0.19 ~ 0.38	2.05	● 0286		
SDCN Ground insert	SDCN 1203 AESN - M		0.18 ~ 0.36	2.04			● 0135
	SDCN 1504 AESN - M		0.18 ~ 0.36	2.19			● 0150
	SDCN 1504 AESN - MR	1	0.18 ~ 0.36	2.19			● 0201

- PW : for Improved Surface Roughness
- GW : Ground Wiper
- M : for Mold & Die
- MR : for Mold & Die Roughing

Cutting Speed			Vc (m/min.)					
ISO	VDI	Sub Group	YG602		YG622		YG712	
			Min	Max	Min	Max	Min	Max
P	1-5	Non-Alloyed Steel	140	380	140	400	170	300
	6-9	Low-Alloyed Steel	120	300	120	320	180	250
	10-11	High-Alloyed Steel	70	150	70	170	100	140
M	12-13	Ferritic & Martensitic	120	200	-	-	-	-
	14	Austenitic Stainless Steel	130	250	-	-	-	-
K	15-16	Grey Cast Iron	120	250	120	270	-	-
	17-18	Nodular Cast Iron	130	220	130	240	-	-
N	21-30	Non-Ferrous Metals (Al)	-	-	-	-	-	-
S	31-37	Superalloys & Titanium	25	45	-	-	-	-
H	38-41	Hard Materials	40	80	40	100	-	-

Milling - Face Milling - Inserts

SEKR / N - Face Milling Positive (4 Corners ISO)

Series	AS	IC	S
SEK* 1203	20°	12.7	3.2

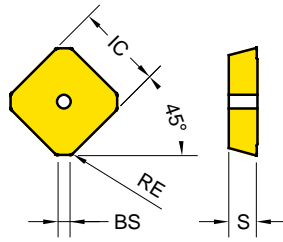

EDP 1200..

P25	P30	P20
M30		
K30	K30	
S20		

● : Stock item
○ : Order made item

SEKR SEKN	Designation	RE (mm)	Fz (mm/tooth)	BS (mm)	EDP 1200..		
					YG602	YG622	YG712
SEKR General	SEKR 1203 AFTN	0.4	0.14 ~ 0.30	1.4	● 0051		
	SEKR 1203 AFTN -PW	0.4	0.14 ~ 0.30	1.4	● 0296		
SEKN Hard Materials	SEKN 1203 AFTN	0.4	0.22 ~ 0.35	1.4	● 0054		
	SEKN 1203 AFTN -PW	0.4	0.22 ~ 0.35	1.4	● 0297		
	SEKN 1203 AFTN -GW	0.4	0.23 ~ 0.35	2	● 0304		

- PW : for Improved Surface Roughness
- GW : Ground Wiper

Cutting Speed			Vc (m/min.)					
ISO	VDI	Sub Group	YG602		YG622		YG712	
			Min	Max	Min	Max	Min	Max
P	1-5	Non-Alloyed Steel	140	380	140	400	170	300
	6-9	Low-Alloyed Steel	120	300	120	320	180	250
	10-11	High-Alloyed Steel	70	150	70	170	100	140
M	12-13	Ferritic & Martensitic	120	200	-	-	-	-
	14	Austenitic Stainless Steel	130	250	-	-	-	-
K	15-16	Grey Cast Iron	120	250	120	270	-	-
	17-18	Nodular Cast Iron	130	220	130	240	-	-
N	21-30	Non-Ferrous Metals (Al)	-	-	-	-	-	-
S	31-37	Superalloys & Titanium	25	45	-	-	-	-
H	38-41	Hard Materials	40	80	40	100	-	-

Milling - Face Milling - Inserts

SEKT - Face Milling Positive (4 Corners)

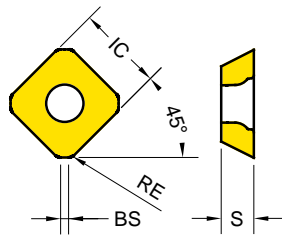

Series	IC	S
SEKT 1204	12.7	4.9
SEKT 12T3	13.4	4

EDP 1200..

P25	P30	P20
M30		
K30	K30	
S20		

● : Stock item
○ : Order made item

SEKT 1204		Designation	RE (mm)	Fz (mm/tooth)	BS (mm)	YG602	YG622	YG712
SEKT 1204 General		SEKT 1204 AFTN	1.1	0.20~0.35	1.18	● 0055		
		SEKT 1204 - ST	1.1	0.08~0.30	1.18	● 0257		

SEKT 12T3		Designation	RE (mm)	Fz (mm/tooth)	BS (mm)	YG602	YG622	YG712
SEKT 12T3 General		SEKT 12T3 AGTN	1.5	0.15~0.30	1.3	● 0056		
		SEKT 12T3 - ST	1.5	0.08~0.30	1.3	● 0271		

Cutting Speed			Vc (m/min.)					
ISO	VDI	Sub Group	YG602		YG622		YG712	
			Min	Max	Min	Max	Min	Max
P	1~5	Non-Alloyed Steel	140	380	140	400	170	300
	6~9	Low-Alloyed Steel	120	300	120	320	180	250
	10~11	High-Alloyed Steel	70	150	70	170	100	140
M	12~13	Ferritic & Martensitic	120	200	-	-	-	-
	14	Austenitic Stainless Steel	130	250	-	-	-	-
K	15~16	Grey Cast Iron	120	250	120	270	-	-
	17~18	Nodular Cast Iron	130	220	130	240	-	-
N	21~30	Non-Ferrous Metals (Al)	-	-	-	-	-	-
S	31~37	Superalloys & Titanium	25	45	-	-	-	-
H	38~41	Hard Materials	40	80	40	100	-	-

SEMT - Face Milling Positive (4 Corners)

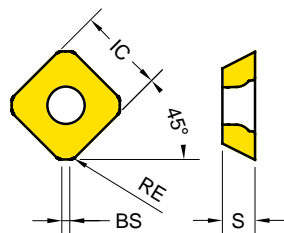

Series	IC	S
SEMT1204	12.92	5.1
SEMT13T3	13.4	4.0

EDP 1200..

P25	P30	P20
M30		
K30	K30	
S20		

● : Stock item

○ : Order made item

SEMT	Designation	RE (mm)	Fz (mm/tooth)	BS (mm)	YG602	YG622	YG712
SEMT 1204 General	SEMT 1204 AFTN	1.2	0.25 ~ 0.5	1.24	● 0052		
SEMT 13T3 General	SEMT 13T3 AGSN	1.5	0.15 ~ 0.3	1.31	● 0203		

Cutting Speed			Vc (m/min.)					
ISO	VDI	Sub Group	YG602		YG622		YG712	
			Min	Max	Min	Max	Min	Max
P	1-5	Non-Alloyed Steel	140	380	140	400	170	300
	6-9	Low-Alloyed Steel	120	300	120	320	180	250
	10-11	High-Alloyed Steel	70	150	70	170	100	140
M	12-13	Ferritic & Martensitic	120	200	-	-	-	-
	14	Austenitic Stainless Steel	130	250	-	-	-	-
K	15-16	Grey Cast Iron	120	250	120	270	-	-
	17-18	Nodular Cast Iron	130	220	130	240	-	-
N	21-30	Non-Ferrous Metals (Al)	-	-	-	-	-	-
S	31-37	Superalloys & Titanium	25	45	-	-	-	-
H	38-41	Hard Materials	40	80	40	100	-	-

Milling - Face Milling - Inserts

SNMX - Face Milling Negative (8 Corners)

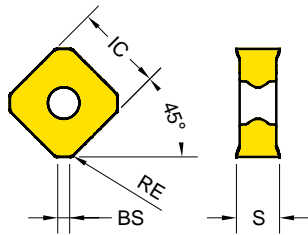

Series	IC	S
SNMX 1206	12.7	6.25

EDP 1200..

P25	P30	P20
M30		
K30	K30	
S20		

● : Stock item
○ : Order made item

SNMX	Designation	RE (mm)	Fz (mm/tooth)	BS (mm)	EDP 1200..		
					YG602	YG622	YG712
	SNMX 1206 ANN	0.8	0.16~0.34	1.7	● 0231		

SNMX
General



Cutting Speed			Vc (m/min.)					
ISO	VDI	Sub Group	YG602		YG622		YG712	
			Min	Max	Min	Max	Min	Max
P	1-5	Non-Alloyed Steel	140	380	140	400	170	300
	6-9	Low-Alloyed Steel	120	300	120	320	180	250
	10-11	High-Alloyed Steel	70	150	70	170	100	140
M	12-13	Ferritic & Martensitic	120	200	-	-	-	-
	14	Austenitic Stainless Steel	130	250	-	-	-	-
K	15-16	Grey Cast Iron	120	250	120	270	-	-
	17-18	Nodular Cast Iron	130	220	130	240	-	-
N	21-30	Non-Ferrous Metals (Al)	-	-	-	-	-	-
S	31-37	Superalloys & Titanium	25	45	-	-	-	-
H	38-41	Hard Materials	40	80	40	100	-	-

Milling - Face Milling - Inserts

SPKN / R/ CN - Face Milling Positive (4 Corners ISO)

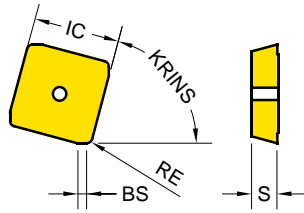

Series	KRINS	AS	IC	S
SP** 1203	75°	11°	12.7	3.2
SP** 1504	75°	11°	15.88	4.8
SP** 1203	75°	11°	12.7	3.18
SP** 1504	75°	11°	15.88	4.76

EDP 1200..

P25	P30	P20
M30		
K30	K30	
S20		

● : Stock item
○ : Order made item

SPKR SPKN		Designation	RE (mm)	Fz (mm/tooth)	BS (mm)	YG602	YG622	YG712
SPKR General		SPKR 1203 EDTR	0.8	0.15 ~ 0.35	1.4	● 0050		
		SPKR 1203 EDTR -PW	0.8	0.15 ~ 0.35	1.4	● 0298		
SPKN Hard Materials		SPKN 1203 EDTR	0.8	0.16 ~ 0.34	1.4	● 0048		
		SPKN 1504 EDTR		0.15 ~ 0.34	1.3	● 0049		
		SPKN 1203 EDTR -PW	0.8	0.20 ~ 0.35	1.4	● 0279		
		SPKN 1504 EDTR -PW		0.25 ~ 0.40	1.3	● 0299		
		SPKN 1203 EDTR -GW	0.6	0.25 ~ 0.5	1.51	● 0280		
		SPKN 1504 EDTR -GW	0.8	0.25 ~ 0.5	2.2	● 0305		
SPCN Ground insert		SPCN 1203 EDSR - M	0.8	0.2 ~ 0.4	1.82			● 0081
		SPCN 1203 EDSR - MR	0.8	0.2 ~ 0.4	1.77			● 0198
		SPCN 1504 EDSR - M	0.8	0.2 ~ 0.4	1.92			● 0098
		SPCN 1504 EDSR - MR	0.8	0.2 ~ 0.4	1.86			● 0199

- PW : for Improved Surface Roughness
- GW : Ground Wiper
- M : for Mold & Die
- MR : for Mold & Die Roughing

Cutting Speed			Vc (m/min.)					
ISO	VDI	Sub Group	YG602		YG622		YG712	
			Min	Max	Min	Max	Min	Max
P	1-5	Non-Alloyed Steel	140	380	140	400	170	300
	6-9	Low-Alloyed Steel	120	300	120	320	180	250
	10-11	High-Alloyed Steel	70	150	70	170	100	140
M	12-13	Ferritic & Martensitic	120	200	-	-	-	-
	14	Austenitic Stainless Steel	130	250	-	-	-	-
K	15-16	Grey Cast Iron	120	250	120	270	-	-
	17-18	Nodular Cast Iron	130	220	130	240	-	-
N	21-30	Non-Ferrous Metals (Al)	-	-	-	-	-	-
S	31-37	Superalloys & Titanium	25	45	-	-	-	-
H	38-41	Hard Materials	40	80	40	100	-	-

Milling - Face Milling - Inserts

SPMT - Universal Positive (4 Corners)

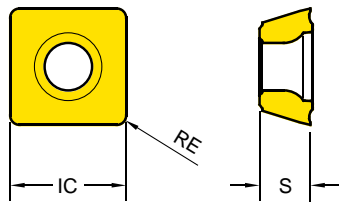

Series	AS	IC	S
SPMT 1204	11°	12.7	4.81

EDP 1200..

P25	P30	P20
M30		
K30	K30	
S20		

● : Stock item
○ : Order made item

SPMT	Designation	RE (mm)	Fz (mm/tooth)	BS (mm)	EDP 1200..		
					YG602	YG622	YG712
	SPMT 120408	0.8	0.15~0.3		● 0223		

SPMT
General



Cutting Speed			Vc (m/min.)					
ISO	VDI	Sub Group	YG602		YG622		YG712	
			Min	Max	Min	Max	Min	Max
P	1-5	Non-Alloyed Steel	140	380	140	400	170	300
	6-9	Low-Alloyed Steel	120	300	120	320	180	250
	10-11	High-Alloyed Steel	70	150	70	170	100	140
M	12-13	Ferritic & Martensitic	120	200	-	-	-	-
	14	Austenitic Stainless Steel	130	250	-	-	-	-
K	15-16	Grey Cast Iron	120	250	120	270	-	-
	17-18	Nodular Cast Iron	130	220	130	240	-	-
N	21-30	Non-Ferrous Metals (Al)	-	-	-	-	-	-
S	31-37	Superalloys & Titanium	25	45	-	-	-	-
H	38-41	Hard Materials	40	80	40	100	-	-

Milling - Face Milling - Inserts

SPUN - Universal Positive (4 Corners ISO)

Series	AS	IC	S
SPUN 1203	11°	12.7	3.2

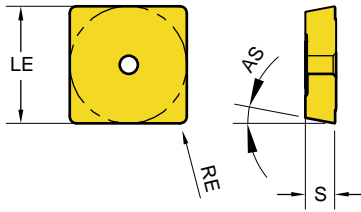

EDP 1200..

● : Stock item
○ : Order made item

P25	P30	P20
M30		
K30	K30	
S20		

SPUN	Designation	RE (mm)	Fz (mm/tooth)	BS (mm)	YG602	YG622	YG712
	SPUN 120308	0.8			● 0224		

SPUN
General



TURNING

PARTING & GROOVING

MILLING

DRILLING

TECHNICAL INFORMATION

Cutting Speed			Vc (m/min.)					
ISO	VDI	Sub Group	YG602		YG622		YG712	
			Min	Max	Min	Max	Min	Max
P	1-5	Non-Alloyed Steel	140	380	140	400	170	300
	6-9	Low-Alloyed Steel	120	300	120	320	180	250
	10-11	High-Alloyed Steel	70	150	70	170	100	140
M	12-13	Ferritic & Martensitic	120	200	-	-	-	-
	14	Austenitic Stainless Steel	130	250	-	-	-	-
K	15-16	Grey Cast Iron	120	250	120	270	-	-
	17-18	Nodular Cast Iron	130	220	130	240	-	-
N	21-30	Non-Ferrous Metals (Al)	-	-	-	-	-	-
S	31-37	Superalloys & Titanium	25	45	-	-	-	-
H	38-41	Hard Materials	40	80	40	100	-	-

Milling - Shoulder Milling - Cutter

Cutters for ADKT, AOMT

Cutting Angle : 90°
2 Corner Positive

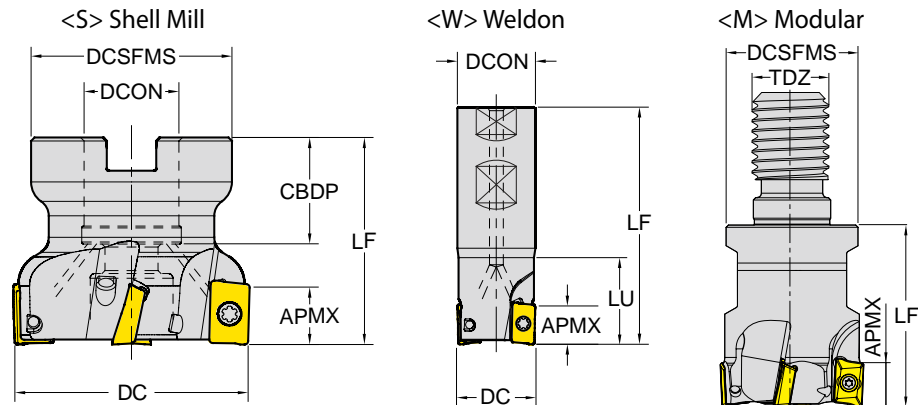

ZEFP : Effective Number of Cutting Edges
CICT : Number of Inserts
CDBP : Connection Bore Depth

: p. 121 unit:mm

Series	APMX	Designation	EDP 1700..	DC	ZEFP	LU	LF	TYPE	DCON	CBDP	DCSFMS	PCD1	PCD2	
ADKT 1505	15.0	E90 - ADKT15 - D25Z2W25 - L150 - WOC	0517	25	2	50	150	Weldon	25	-	-	-	-	X
		E90 - ADKT15 - D30Z3W25 - L150 - WOC	0518	30	3	40	150		25	-	-	-	-	X
		E90 - ADKT15 - D32Z3W32 - L150 - WOC	0519	32	3	50	150		32	-	-	-	-	X
		F90 - ADKT15 - D40Z4S16	0520	40	4	-	40	Shellmill	16	20	36	-	-	●
		F90 - ADKT15 - D50Z5S22	0521	50	5	-	40		22	22	42	-	-	●
		F90 - ADKT15 - D63Z6S22	0522	63	6	-	40		22	22	48	-	-	●
		F90 - ADKT15 - D80Z7S27	0523	80	7	-	50		27	25	58	-	-	●
		F90 - ADKT15 - D100Z8S32	0524	100	8	-	50		32	26	65	-	-	●
F90 - ADKT15 - D125Z9S40 - WOC	0525	125	9	-	63	40	32	80	-	-	X			

: p. 121 unit:mm

Series	APMX	Designation	EDP 1700..	DC	ZEFP	LU	LF	TYPE	DCON	CBDP	DCSFMS	PCD1	PCD2	
AOMT 1236	12.0	E90 - AOMT12 - D16Z2W16 - L150 - WOC	0526	16	2	50	150	Weldon	16	-	-	-	-	X
		E90 - AOMT12 - D25Z3W25 - L150 - WOC	0527	25	3	50	150		25	-	-	-	-	X
		E90 - AOMT12 - D32Z4W32 - L150 - WOC	0528	32	4	50	150		32	-	-	-	-	X
		F90 - AOMT12 - D50Z5S22	0529	50	5	-	40	Shellmill	22	22	42	-	-	●
		M90 - AOMT12 - D16Z2M08 - WOC	0530	16	2	-	30	Modular	M08	-	14.8	-	-	X
		M90 - AOMT12 - D20Z3M10 - WOC	0531	20	3	-	35		M10	-	18	-	-	X

Milling - Shoulder Milling - Cutter

Cutters for APKT

Cutting Angle : 90°
2 Corner Positive

<W> Weldon

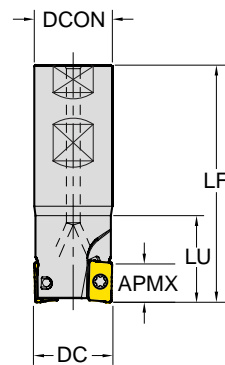

<C> Cyindrical

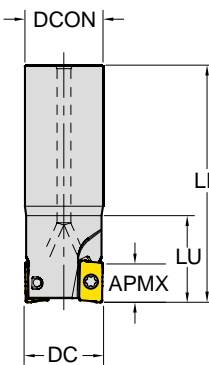

ZEFP : Effective Number of Cutting Edges
CICT : Number of Inserts
CBDP : Connection Bore Depth

: p. 122 unit:mm

Series	APMX	Designation	EDP 1700..	DC	ZEFP	LU	LF	TYPE	DCON	CBDP	DCSFMS	PCD1	PCD2	
APKT 1003	10.0	E90 - APKT10 - D16Z2C16 - L100	0083	16	2	-	100	Cylindrical	16	-	-	-	-	●
		E90 - APKT10 - D16Z2C16 - L120	0532	16	2	30	120		16	-	-	-	-	●
		E90 - APKT10 - D16Z2C16 - L150	0154	16	2	50	150		16	-	-	-	-	●
		E90 - APKT10 - D16Z2C16 - L200	0533	16	2	100	200		16	-	-	-	-	●
		E90 - APKT10 - D20Z2C20 - L250	0534	20	2	150	250		20	-	-	-	-	●
		E90 - APKT10 - D20Z3C20 - L100	0535	20	3	30	100		20	-	-	-	-	●
		E90 - APKT10 - D20Z3C20 - L120	0085	20	3	-	120		20	-	-	-	-	●
		E90 - APKT10 - D20Z3C20 - L150	0536	20	3	50	150		20	-	-	-	-	●
		E90 - APKT10 - D20Z3C20 - L200	0270	20	3	100	200		20	-	-	-	-	●
		E90 - APKT10 - D25Z3C25 - L100	0537	25	3	30	100		25	-	-	-	-	●
		E90 - APKT10 - D25Z3C25 - L120	0186	25	3	30	120	25	-	-	-	-	●	
		E90 - APKT10 - D30Z4C25 - L100	0122	30	4	30	100	25	-	-	-	-	●	
		E90 - APKT10 - D30Z4C25 - L120	0086	30	4	30	120	25	-	-	-	-	●	
		E90 - APKT10 - D32Z4C25 - L100	0538	32	4	35	100	25	-	-	-	-	●	
		E90 - APKT10 - D32Z4C25 - L150 - WOC	0539	32	4	35	150	25	-	-	-	-	X	
		E90 - APKT10 - D12Z1W16 - L100	0540	12	1	30	100	Weldon	16	-	-	-	-	●
		E90 - APKT10 - D14Z1W16 - L100	0541	14	1	30	100		16	-	-	-	-	●
		E90 - APKT10 - D16Z2W16 - L100	0542	16	2	30	100		16	-	-	-	-	●
		E90 - APKT10 - D16Z2W16 - L85	0082	16	2	-	85		16	-	-	-	-	●
		E90 - APKT10 - D18Z2W16 - L100	0543	18	2	30	100		16	-	-	-	-	●

▶ NEXT PAGE

Milling - Shoulder Milling - Cutter

Cutters for APKT

Cutting Angle : 90°
2 Corner Positive

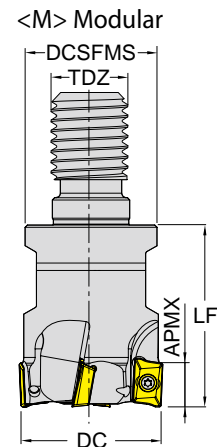
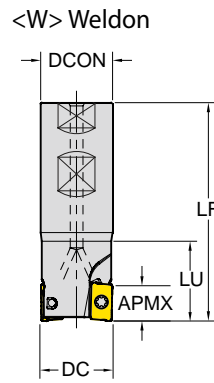
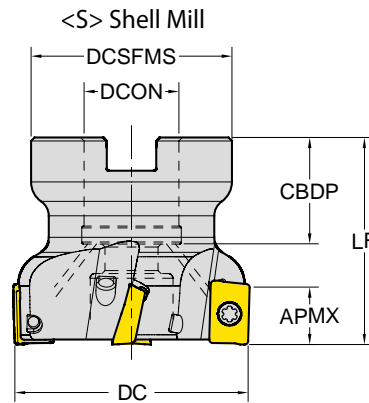

ZEFP : Effective Number of Cutting Edges
CICT : Number of Inserts
CDBP : Connection Bore Depth

: p.122 unit:mm

Series	APMX	Designation	EDP 1700..	DC	ZEFP	LU	LF	TYPE	DCON	CBDP	DCSFMS	PCD1	PCD2		
APKT 1003	10.0	E90 - APKT10 - D20Z3W20 - L100	0461	20	3	30	100	Weldon	20	-	-	-	-	●	
		E90 - APKT10 - D20Z3W20 - L90	0084	20	3	-	90		20	-	-	-	-	-	●
		E90 - APKT10 - D22Z3W20 - L100	0544	22	3	30	100		20	-	-	-	-	-	●
		E90 - APKT10 - D25Z3W25 - L100	0545	25	3	30	100		25	-	-	-	-	-	●
		E90 - APKT10 - D25Z4W25 - L100	0546	25	4	30	100		25	-	-	-	-	-	●
		E90 - APKT10 - D32Z4W32 - L150 - WOC	0547	32	4	50	150		32	-	-	-	-	-	X
	F90 - APKT10 - D40Z4S16	0087	40	4	-	40	Shellmill	16	18	34	-	-	-	●	
	F90 - APKT10 - D40Z5S16	0472	40	5	-	40		16	20	36	-	-	-	●	
	F90 - APKT10 - D50Z6S22	0215	50	6	-	40		22	22	42	-	-	-	●	
	F90 - APKT10 - D50Z7S22	0088	50	7	-	40		22	20	42	-	-	-	●	
	F90 - APKT10 - D63Z7S22	0548	63	7	-	40		22	22	48	-	-	-	●	
	F90 - APKT10 - D80Z8S27	0549	80	8	-	50		27	25	58	-	-	-	●	
	F90 - APKT10 - D100Z9S32	0550	100	9	-	50	32	26	65	-	-	-	●		
	M90 - APKT10 - D16Z2M08	0551	16	2	-	30	Modular	M08	-	14.75	-	-	-	●	
	M90 - APKT10 - D20Z3M10	0552	20	3	-	30		M10	-	18	-	-	-	●	
	M90 - APKT10 - D25Z3M12	0553	25	3	-	35		M12	-	21	-	-	-	●	
	M90 - APKT10 - D32Z4M16	0554	32	4	-	35		M16	-	29	-	-	-	●	
	M90 - APKT10 - D40Z5M16	0555	40	5	-	43		M16	-	29	-	-	-	●	
M90 - APKT10 - D42Z5M16	0556	42	5	-	43	M16		-	29	-	-	-	●		

Milling - Shoulder Milling - Cutter

Cutters for APKT

Cutting Angle : 90°
2 Corner Positive

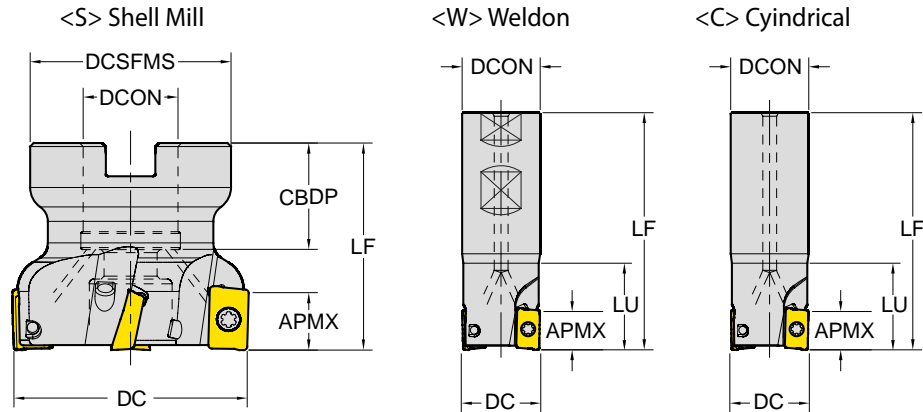

ZEFP : Effective Number of Cutting Edges
CICT : Number of Inserts
CDBP : Connection Bore Depth

□ : p. 122 unit:mm

Series	APMX	Designation	EDP 1700..	DC	ZEFP	LU	LF	TYPE	DCON	CDBP	DCSFMS	PCD1	PCD2	☐			
APKT 1604	16.0	E90 - APKT16 - D25Z2C20 - L100	0091	25	2	-	100	Cylindrical	20	-	-	-	-	●			
		E90 - APKT16 - D25Z2C20 - L100 - WOC	0243	25	2	35	100		20	-	-	-	-	X	●		
		E90 - APKT16 - D25Z2C25 - L250 - WOC	0557	25	2	100	250		25	-	-	-	-	X	●		
		E90 - APKT16 - D32Z2C32 - L250 - WOC	0558	32	2	100	250		32	-	-	-	-	X	●		
		E90 - APKT16 - D32Z3C25 - L110	0094	32	3	-	110		25	-	-	-	-	-	●		
		E90 - APKT16 - D32Z3C25 - L200	0559	32	3	40	200		25	-	-	-	-	-	●		
		E90 - APKT16 - D32Z3C32 - L150 - WOC	0250	32	3	50	150		32	-	-	-	-	-	X	●	
		E90 - APKT16 - D32Z3C32 - L250 - WOC	0560	32	3	100	250		32	-	-	-	-	-	X	●	
		E90 - APKT16 - D40Z4C32 - L150 - WOC	0561	40	4	40	150		32	-	-	-	-	-	X	●	
		E90 - APKT16 - D25Z2W25 - L100	0562	25	2	35	100	Weldon	25	-	-	-	-	-	●		
		E90 - APKT16 - D25Z2W25 - L110	0092	25	2	-	110		25	-	-	-	-	-	-	●	
		E90 - APKT16 - D28Z3W25 - L100	0563	28	3	40	100		25	-	-	-	-	-	-	●	
		E90 - APKT16 - D30Z3W25 - L110	0564	30	3	40	110		25	-	-	-	-	-	-	●	
		E90 - APKT16 - D32Z3W25 - L110	0093	32	3	-	110		25	-	-	-	-	-	-	●	
		E90 - APKT16 - D32Z3W32 - L110	0565	32	3	40	110		32	-	-	-	-	-	-	●	
		E90 - APKT16 - D36Z3W32 - L110	0566	36	3	40	110		32	-	-	-	-	-	-	●	
		F90 - APKT16 - D40Z4S16	0275	40	4	-	40		Shellmill	16	20	36	-	-	-	-	●
		F90 - APKT16 - D50Z5S22	0095	50	5	-	40			22	20	45	-	-	-	-	●

▶ NEXT PAGE

Milling - Shoulder Milling - Cutter

Cutters for APKT

Cutting Angle : 90°
2 Corner Positive

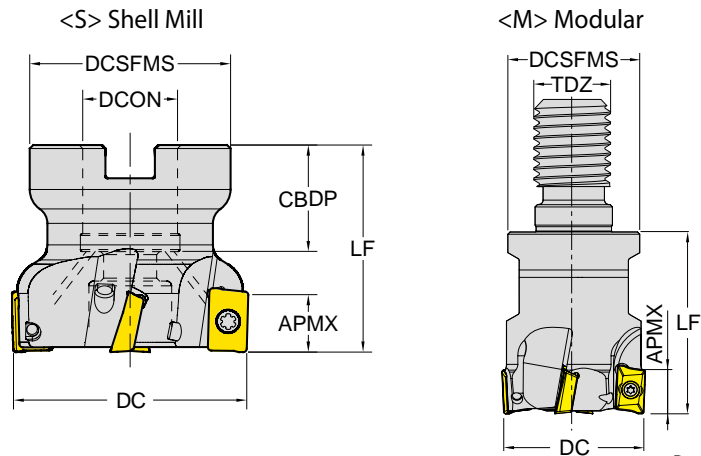

ZAFP : Effective Number of Cutting Edges
CICT : Number of Inserts
CBDP : Connection Bore Depth

: p.122 unit:mm

Series	APMX	Designation	EDP 1700..	DC	ZAFP	LU	LF	TYPE	DCON	CBDP	DCSFMS	PCD1	PCD2	
APKT 1604	16.0	F90 - APKT16 - D52Z5S22	0567	52	5	-	40	Shellmill	22	22	42	-	-	●
		F90 - APKT16 - D63Z6S22	0096	63	6	-	40		22	20	50	-	-	●
		F90 - APKT16 - D80Z7S27	0097	80	7	-	50		27	23	56	-	-	●
		F90 - APKT16 - D100Z8S32	0181	100	8	-	50		32	26	65	-	-	●
		F90 - APKT16 - D125Z9S40 - WOC	0238	125	9	-	63		40	32	80	-	-	X
		F90 - APKT16 - D160Z10S40 - WOC	0568	160	10	-	63		40	32	110	66.7	-	X
		F90 - APKT16 - D200Z12S60 - WOC	0569	200	12	-	63		60	40	130	101.6	-	X
M90 - APKT16 - D25Z2M12	0570	25	2	-	43	Modular	M12	-	21	-	-	●		
M90 - APKT16 - D32Z3M16	0571	32	3	-	43		M16	-	29	-	-	●		
M90 - APKT16 - D42Z4M16	0572	42	4	-	43		M16	-	29	-	-	●		

Milling - Shoulder Milling - Cutter

Cutters for APMT

Cutting Angle : 90°
2 Corner Positive

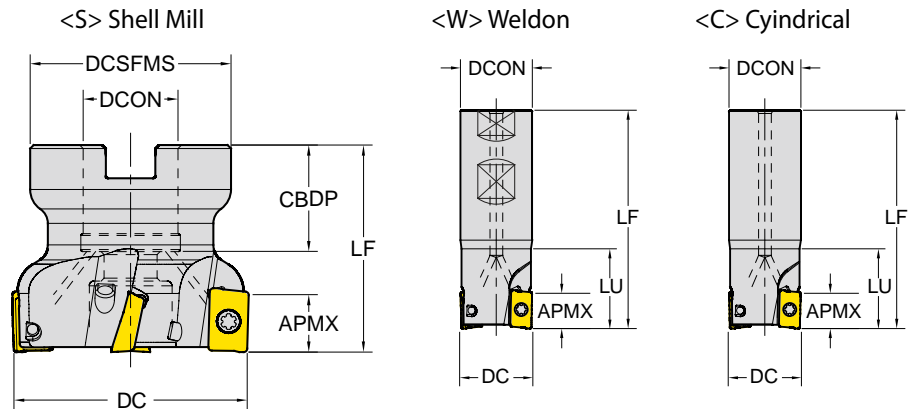

ZEFP : Effective Number of Cutting Edges
CICT : Number of Inserts
CBDP : Connection Bore Depth

: p. 123 unit:mm

Series	APMX	Designation	EDP 1700..	DC	ZEFP	LU	LF	TYPE	DCON	CBDP	DCSFMS	PCD1	PCD2	
APMT 1135	10.0	E90 - APMT11 - D16Z2C16 - L120	0102	16	2	-	120	Cylindrical	16	-	-	-	-	●
		E90 - APMT11 - D20Z2C20 - L120	0103	20	2	-	120		20	-	-	-	-	●
		E90 - APMT11 - D25Z4C25 - L150	0104	25	4	-	150		25	-	-	-	-	●
		E90 - APMT11 - D32Z4W25 - L110	0105	32	4	-	110	Weldon	25	-	-	-	-	●
APMT 1604	16.0	E90 - APMT16 - D25Z2C25 - L120	0107	25	2	-	120	Cylindrical	25	-	-	-	-	●
		E90 - APMT16 - D32Z3W32 - L110	0108	32	3	-	110	Weldon	32	-	-	-	-	●
		F90 - APMT16 - D50Z5S22	0109	50	5	-	40	Shellmill	22	20	42	-	-	●
		F90 - APMT16 - D63Z6S22	0110	63	6	-	40		22	20	50	-	-	●
		F90 - APMT16 - D80Z7S27	0111	80	7	-	50		27	23	56	-	-	●

Milling - Shoulder Milling - Helical Cutter

Cutters for APKT

Cutting Angle : 90°
2 Corner Positive

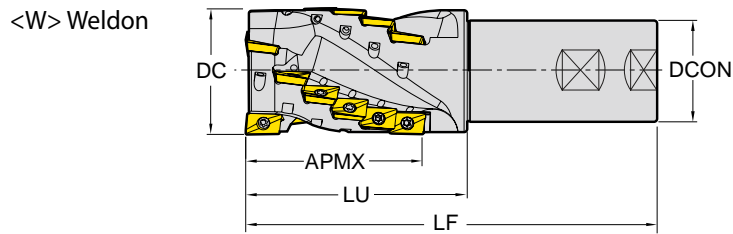

ZEFP : Effective Number of Cutting Edges
CICT : Number of Inserts

: p.122 unit:mm

Series	APMX	Designation	EDP 1700..	DC	ZEFP	CICT *	LU	LF	TYPE	DCON	
APKT 1003	37.0	E90 - APKT10 - D25AP37Z208W25 - L105	0573	25	2	8	50	105	Weldon	25	●
	46.0	E90 - APKT10 - D32AP46Z315W32 - L115	0574	32	3	15	55	115		32	●
	55.0	E90 - APKT10 - D40AP55Z318W32 - L130	0575	40	3	18	70	130		32	●

* : No. of inserts

Milling - Shoulder Milling - Cutter

Cutters for TPKN, TPKR, TPCN

Cutting Angle : 90°
3 Corner Positive ISO

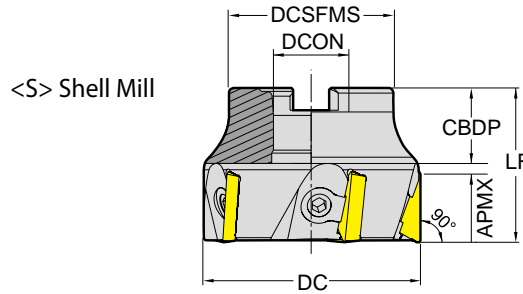

ZEFP : Effective Number of Cutting Edges
CICT : Number of Inserts
CDBP : Connection Bore Depth

□ : p. 124 unit:mm

Series	APMX	Designation	EDP 1700..	DC	ZEFP	LU	LF	TYPE	DCON	CBDP	DCSFMS	PCD1	PCD2	☉
TPKN TPKR TPCN 1603	12.0	F90 - TPKN16 - D50Z4S22 - WOC	0618	50	4	-	40	Shellmill	22	22	42	-	-	X
		F90 - TPKN16 - D63Z6S22 - WOC	0619	63	6	-	45		22	22	48	-	-	X
		F90 - TPKN16 - D80Z7S27 - WOC	0620	80	7	-	50		27	25	58	-	-	X
		F90 - TPKN16 - D125Z8S40 - WOC	0621	125	8	-	63		40	32	80	-	-	X
TPKN TPKR TPCN 2204	18.0	F90 - TPKN22 - D63Z5S22 - WOC	0622	63	5	-	45	Shellmill	22	22	48	-	-	X
		F90 - TPKN22 - D80Z6S27 - WOC	0623	80	6	-	50		27	25	58	-	-	X
		F90 - TPKN22 - D100Z7S32 - WOC	0624	100	7	-	50		32	26	65	-	-	X
		F90 - TPKN22 - D125Z8S40 - WOC	0625	125	8	-	63		40	32	80	-	-	X
		F90 - TPKN22 - D160Z9S40 - WOC	0626	160	9	-	63		40	32	110	66.7	-	X
		F90 - TPKN22 - D200Z12S60 - WOC	0627	200	12	-	63		60	40	130	101.6	-	X
		F90 - TPKN22 - D250Z15S60 - WOC	0628	250	15	-	63		60	40	160	101.6	-	X
		F90 - TPKN22 - D315Z18S60 - WOC	0629	315	18	-	63		60	40	220	101.6	177.8	X

Milling - Shoulder Milling - Inserts

ADKT / AOMT - Shoulder Milling Positive (2 Corner)

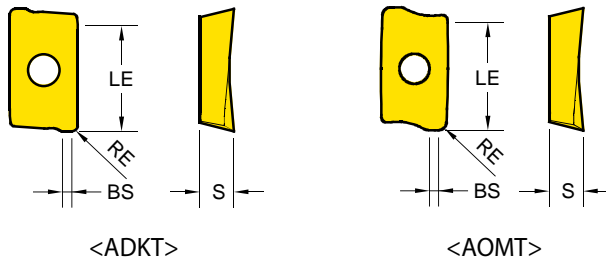



Series	LE	IC	S
ADKT 1505	13.7	9.7	5.8
AOMT 1236	10.5	6.6	3.6

EDP 1200..

P25	P30	P20
M30		
K30	K30	
S20		

● : Stock item
○ : Order made item

ADKT	Designation	RE (mm)	Fz (mm/tooth)	BS (mm)	YG602	YG622	YG712
ADKT General 	ADKT 150508 PDTR	0.8	0.16 ~ 0.30	1.87	● 0220		

AOMT	Designation	RE (mm)	Fz (mm/tooth)	BS (mm)	YG602	YG622	YG712
AOMT General 	AOMT 123604 PDTR	0.4	0.08 ~ 0.22	1.07	● 0217		
	AOMT 123608 PDTR	0.8	0.08 ~ 0.24	0.91	● 0218		

Cutting Speed			Vc (m/min.)					
ISO	VDI	Sub Group	YG602		YG622		YG712	
			Min	Max	Min	Max	Min	Max
P	1-5	Non-Alloyed Steel	140	380	140	400	170	300
	6-9	Low-Alloyed Steel	120	300	120	320	180	250
	10-11	High-Alloyed Steel	70	150	70	170	100	140
M	12-13	Ferritic & Martensitic	120	200	-	-	-	-
	14	Austenitic Stainless Steel	130	250	-	-	-	-
K	15-16	Grey Cast Iron	120	250	120	270	-	-
	17-18	Nodular Cast Iron	130	220	130	240	-	-
N	21-30	Non-Ferrous Metals (Al)	-	-	-	-	-	-
S	31-37	Superalloys & Titanium	25	45	-	-	-	-
H	38-41	Hard Materials	40	80	40	100	-	-

Milling - Shoulder Milling - Inserts APKT - Shoulder Milling Positive (2 Corner)

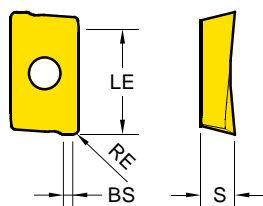

Series	LE	IC	S
APKT 1003	9.9	6.7	3.6
APKT 1604	15.2	9.4	5.3



TURNING

PARTING & GROOVING

MILLING

DRILLING

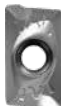
TECHNICAL INFORMATION

APKT	Designation	RE (mm)	Fz (mm/tooth)	BS (mm)	EDP 1200..		
					YG602	YG622	YG712
APKT General 	APKT 100305 PDTR	0.5	0.15 ~ 0.24	0.86	● 0005		
	APKT 100308 PDTR	0.8	0.15 ~ 0.24	0.9	● 0004		
	APKT 160404 PDTR	0.4	0.15 ~ 0.25	1.11	● 0003		
	APKT 160408 PDTR	0.8	0.15 ~ 0.30	1.32	● 0001		
	APKT 160412 PDTR	1.2	0.15 ~ 0.32	1.13	● 0002		
	APKT 160416 PDTR	1.6	0.15 ~ 0.34	1.13	● 0006		
	APKT 160424 PDTR	2.4	0.15 ~ 0.28		● 0255		
-ST Stainless Steel Super Alloy 	APKT 100305 - ST	0.5	0.08 ~ 0.22	0.86	● 0278		
	APKT 160408 - ST	0.8	0.08 ~ 0.25	1.32	● 0270		
-TR Hardened Steel 	APKT 160404 - TR	0.4	0.26 ~ 0.40	2.12	● 0492		
	APKT 160408 - TR	0.8	0.26 ~ 0.40	1.32	● 0256	● 0337	
	APKT 160412 - TR	1.2	0.26 ~ 0.40	2.4	● 0493		
	APKT 160416 - TR	1.6	0.26 ~ 0.40	2.4	● 0472		
	APKT 160424 - TR	2.4	0.26 ~ 0.40	1.5	● 0494		

● : Stock item

○ : Order made item

EDP 1200..

P25 P30 P20

M30

K30 K30

S20

Cutting Speed			Vc (m/min.)					
ISO	VDI	Sub Group	YG602		YG622		YG712	
			Min	Max	Min	Max	Min	Max
P	1-5	Non-Alloyed Steel	140	380	140	400	170	300
	6-9	Low-Alloyed Steel	120	300	120	320	180	250
	10-11	High-Alloyed Steel	70	150	70	170	100	140
M	12-13	Ferritic & Martensitic	120	200	-	-	-	-
	14	Austenitic Stainless Steel	130	250	-	-	-	-
K	15-16	Grey Cast Iron	120	250	120	270	-	-
	17-18	Nodular Cast Iron	130	220	130	240	-	-
N	21-30	Non-Ferrous Metals (Al)	-	-	-	-	-	-
S	31-37	Superalloys & Titanium	25	45	-	-	-	-
H	38-41	Hard Materials	40	80	40	100	-	-

Milling - Shoulder Milling - Inserts

APMT - Shoulder Milling Positive (2 Corner)

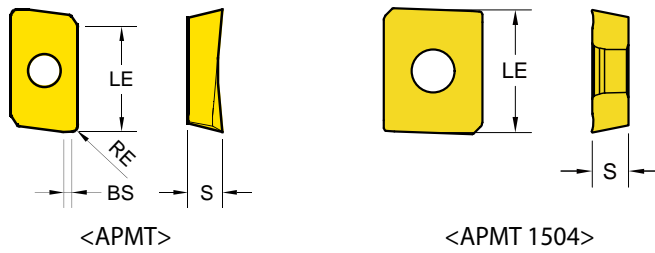

Series	LE	IC	S
APMT 1135	9.5	6.2	3.5
APMT 1604	14.6	9.2	4.76
APMT 1504	14	12.7	4.76

EDP 1200..

P25	P30	P20
M30		
K30	K30	
S20		

● : Stock item
○ : Order made item

APMT		Designation	RE (mm)	Fz (mm/tooth)	BS (mm)	YG602	YG622	YG712
APMT General		APMT 113504 PDTR	0.4	0.15~0.22	1.26	● 0009		
		APMT 113508 PDTR	0.8	0.15~0.25	1.07	● 0010		
		APMT 160408 PDTR	0.8	0.16~0.30	1.11	● 0008		● 0423
APMT 1504 General		APMT 1504		0.14~0.28		● 0276	● 0445	

Cutting Speed			Vc (m/min.)					
ISO	VDI	Sub Group	YG602		YG622		YG712	
			Min	Max	Min	Max	Min	Max
P	1~5	Non-Alloyed Steel	140	380	140	400	170	300
	6~9	Low-Alloyed Steel	120	300	120	320	180	250
	10~11	High-Alloyed Steel	70	150	70	170	100	140
M	12~13	Ferritic & Martensitic	120	200	-	-	-	-
	14	Austenitic Stainless Steel	130	250	-	-	-	-
K	15~16	Grey Cast Iron	120	250	120	270	-	-
	17~18	Nodular Cast Iron	130	220	130	240	-	-
N	21~30	Non-Ferrous Metals (Al)	-	-	-	-	-	-
S	31~37	Superalloys & Titanium	25	45	-	-	-	-
H	38~41	Hard Materials	40	80	40	100	-	-

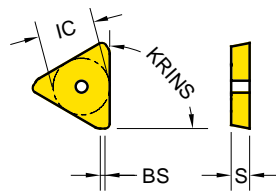

Milling - Shoulder Milling - Inserts

TPKN / KR / CN - Shoulder Milling Positive (3 Corner ISO)



Series	KRINS	IC	S
TP** 1603	90°	9.53	3.18
TP** 2204	90°	12.7	4.76

TURNING
PARTING & GROOVING
MILLING
DRILLING
TECHNICAL INFORMATION

TPKR TPKN	Designation	RE (mm)	Fz (mm/tooth)	BS (mm)	EDP 1200..		
					YG602	YG622	YG712
TPKR General 	TPKR 1603 PDTR		0.15 ~ 0.28	1.2	● 0060		
	TPKR 1603 PDTR-PW		0.15 ~ 0.28	1.2	● 0300		
	TPKR 2204 PDTR		0.18 ~ 0.35	1.7	● 0061		
	TPKR 2204 PDTR-PW		0.18 ~ 0.35	1.7	● 0301		
TPKN Hard Materials 	TPKN 1603 PDTR		0.15 ~ 0.30	1.2	● 0062		
	TPKN 2204 PDTR		0.17 ~ 0.30	1.7	● 0063		
	TPKN 1603 PDTR-PW		0.20 ~ 0.35	1.2	● 0302		
	TPKN 2204 PDTR-PW		0.24 ~ 0.40	1.7	● 0303		
	TPKN 1603 PDTR-GW		0.15 ~ 0.3	1.62	● 0306		
	TPKN 2204 PDTR-GW		0.24 ~ 0.4	2.49	● 0307		
TPCN Ground insert 	TPCN 2204 PDSR-M		0.2 ~ 0.4	1.76			● 0180
	TPCN 2204 PDSR-MR		0.2 ~ 0.4	1.76			● 0202

● : Stock item
○ : Order made item

- PW : for Improved Surface Roughness
- GW : Ground Wiper
- M : for Mold & Die
- MR : for Mold & Die Roughing

Cutting Speed			Vc (m/min.)					
ISO	VDI	Sub Group	YG602		YG622		YG712	
			Min	Max	Min	Max	Min	Max
P	1-5	Non-Alloyed Steel	140	380	140	400	170	300
	6-9	Low-Alloyed Steel	120	300	120	320	180	250
	10-11	High-Alloyed Steel	70	150	70	170	100	140
M	12-13	Ferritic & Martensitic	120	200	-	-	-	-
	14	Austenitic Stainless Steel	130	250	-	-	-	-
K	15-16	Grey Cast Iron	120	250	120	270	-	-
	17-18	Nodular Cast Iron	130	220	130	240	-	-
N	21-30	Non-Ferrous Metals (Al)	-	-	-	-	-	-
S	31-37	Superalloys & Titanium	25	45	-	-	-	-
H	38-41	Hard Materials	40	80	40	100	-	-

Milling - Shoulder Milling - Inserts

TPUN- Universal Positive (3 Corners ISO)

Series	KRINS	IC	S
TPUN 1603	-	9.53	3.18

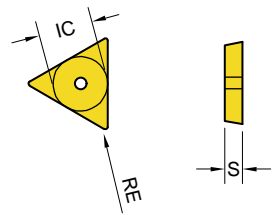

EDP 1200..

P25	P30	P20
M30		
K30	K30	
S20		

● : Stock item
○ : Order made item

TPUN	Designation	RE (mm)	Fz (mm/tooth)	BS (mm)	EDP 1200..		
					YG602	YG622	YG712
	TPUN 160308	0.8	0.08 ~ 0.15		● 0064		

TPUN



Cutting Speed			Vc (m/min.)					
ISO	VDI	Sub Group	YG602		YG622		YG712	
			Min	Max	Min	Max	Min	Max
P	1-5	Non-Alloyed Steel	140	380	140	400	170	300
	6-9	Low-Alloyed Steel	120	300	120	320	180	250
	10-11	High-Alloyed Steel	70	150	70	170	100	140
M	12-13	Ferritic & Martensitic	120	200	-	-	-	-
	14	Austenitic Stainless Steel	130	250	-	-	-	-
K	15-16	Grey Cast Iron	120	250	120	270	-	-
	17-18	Nodular Cast Iron	130	220	130	240	-	-
N	21-30	Non-Ferrous Metals (Al)	-	-	-	-	-	-
S	31-37	Superalloys & Titanium	25	45	-	-	-	-
H	38-41	Hard Materials	40	80	40	100	-	-

Milling - Profiling - Cutter

Cutters for RDKT, RDKW

Round Positive

<S> Shell Mill

<W> Weldon

<C> Cylindrical

<M> Modular

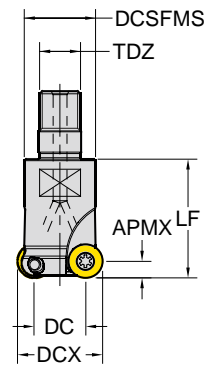
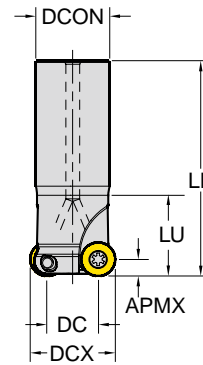
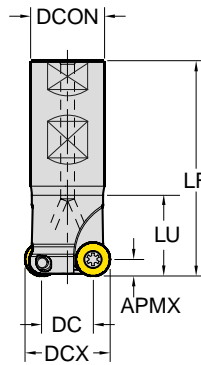
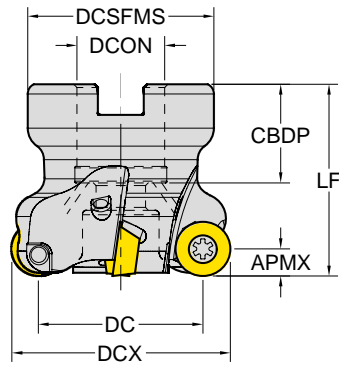

ZEFP : Effective Number of Cutting Edges
 CBDP : Connection Bore Depth

□ : p. 129 unit:mm

Series	APMX	Designation	EDP 1700..	DC	DCX	ZEFP	LU	LF	TYPE	DCON	CBDP	DCSFMS	☉
RDKT RDKW 0802	4.0	E - RDKT08 - D16Z2C16 - L160	0005	8	16	2	-	160	Cylindrical	16	-	-	●
		E - RDKT08 - D20Z2C20 - L180	0007	12	20	2	-	180		20	-	-	●
		E - RDKT08 - D25Z3C20 - L180	0009	17	25	3	-	180		20	-	-	●
		M - RDKT08 - D16Z2M08	0010	8	16	2	-	23	Modular	M08	-	13	●
		M - RDKT08 - D20Z2M10	0011	12	20	2	-	30		M10	-	18	●
		M - RDKT08 - D25Z3M12	0012	17	25	3	-	35		M12	-	21	●
RDKT RDKW 10T3	5.0	E - RDKT10 - D20Z2C20 - L150 - WOC	0576	10	20	2	60	150	Cylindrical	20	-	-	X
		E - RDKT10 - D20Z2C20 - L180	0013	10	20	2	-	180		20	-	-	●
		E - RDKT10 - D25Z2C25 - L150 - WOC	0299	15	25	2	60	150		25	-	-	X
		E - RDKT10 - D25Z2C25 - L180	0015	15	25	2	-	180		25	-	-	●
		E - RDKT10 - D20Z2W20 - L150 - WOC	0577	10	20	2	60	150	Weldon	20	-	-	X
		E - RDKT10 - D25Z2W25 - L150 - WOC	0578	15	25	2	60	150		25	-	-	X
		E - RDKT10 - D32Z3W32 - L150 - WOC	0579	22	32	3	60	150		32	-	-	X
		F - RDKT10 - D40Z5S16	0019	30	40	5	-	40	Shellmill	16	18	34	●
		F - RDKT10 - D50Z5S22	0580	40	50	5	-	50		22	22	42	●
		F - RDKT10 - D50Z6S22	0020	40	50	6	-	50		22	22	42	●
		F - RDKT10 - D63Z6S22	0581	53	63	6	-	50		22	22	48	●
M - RDKT10 - D20Z2M10	0017	10	20	2	-	30	Modular	M10	-	18	●		
M - RDKT10 - D25Z3M12	0018	15	25	3	-	35		M12	-	21	●		

Milling - Profiling - Cutter

Cutters for RDKT, RDKW

Round Positive

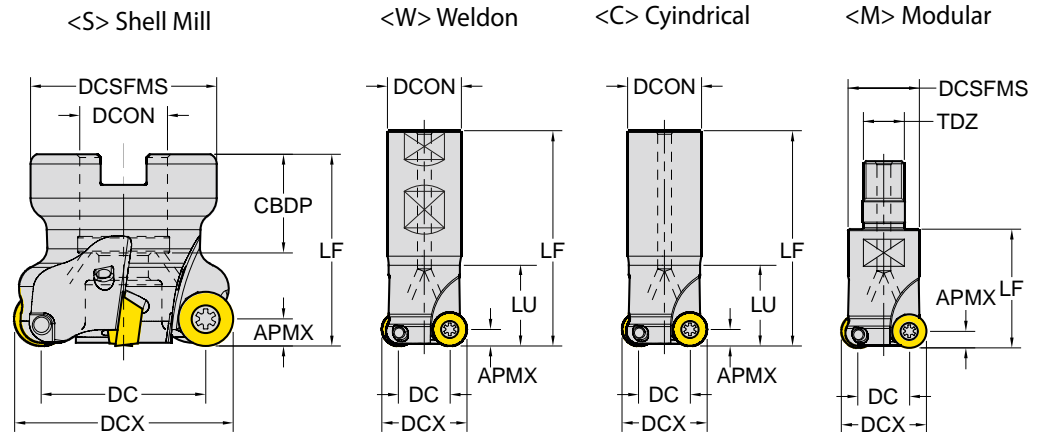

ZEFP : Effective Number of Cutting Edges
 CDBP : Connection Bore Depth

: p.129 unit:mm

Series	APMX	Designation	EDP 1700..	DC	DCX	ZEFP	LU	LF	TYPE	DCON	CBDP	DCSFMS	
RDKT RDKW 1204	6.0	E - RDKT12 - D25Z2C25 - L180	0021	13	25	2	-	180	Cylindrical	25	-	-	●
		E - RDKT12 - D32Z2C32 - L200	0023	20	32	2	-	200		32	-	-	●
		E - RDKT12 - D32Z3C32 - L160	0024	20	32	3	-	160		32	-	-	●
		E - RDKT12 - D32Z3C32 - L160 - WOC	0582	20	32	3	70	160		32	-	-	X
		E - RDKT12 - D33Z3C32 - L160 - WOC	0583	21	33	3	70	160		32	-	-	X
		E - RDKT12 - D32Z3W32 - L160 - WOC	0584	20	32	3	50	160	Weldon	32	-	-	X
		F - RDKT12 - D40Z4S16	0028	28	40	4	-	40	Shellmill	16	18	34	●
		F - RDKT12 - D50Z5S22	0029	38	50	5	-	50		22	22	42	●
		F - RDKT12 - D52Z5S22	0585	40	52	5	-	50		22	22	42	●
		F - RDKT12 - D63Z6S22	0030	51	63	6	-	50		22	20	48	●
		F - RDKT12 - D80Z7S27	0586	68	80	7	-	50		27	25	58	●
		F - RDKT12 - D100Z7S32	0587	88	100	7	-	50		32	26	65	●
		F - RDKT12 - D100Z8S32	0588	88	100	8	-	50		32	26	65	●
M - RDKT12 - D25Z2M12	0026	13	25	2	-	35	Modular	M12	-	21	●		
M - RDKT12 - D32Z3M16	0027	20	32	3	-	42		M16	-	29	●		
M - RDKT12 - D42Z4M16	0589	30	42	4	-	43		M16	-	29	●		

Milling - Profiling - Cutter

Cutters for RPMT, RPMW

Round Positive

<S> Shell Mill

<W> Weldon

<C> Cylindrical

<M> Modular

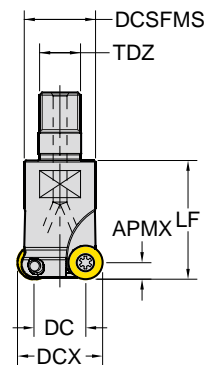
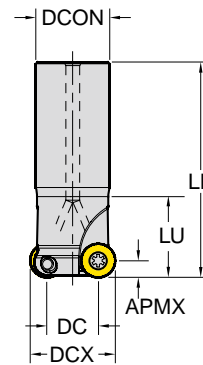
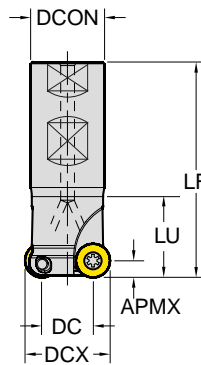
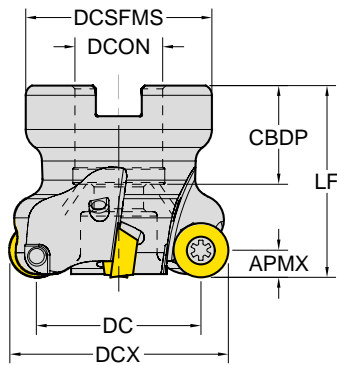

ZEFP : Effective Number of Cutting Edges
CDBP : Connection Bore Depth

□ : p. 131 unit:mm

Series	APMX	Designation	EDP 1700..	DC	DCX	ZEFP	LU	LF	TYPE	DCON	CDBP	DCSFMS	☉
RPMT RPMW 08T2	4.0	E - RPMT08 - D20Z2W20 - L150	0590	12	20	2	60	150	Weldon	20	-	-	●
		E - RPMT08 - D25Z3W25 - L200	0591	17	25	3	100	200		25	-	-	●
		M - RPMT08 - D20Z2M10	0592	12	20	2	-	30	Modular	M10	-	18	●
RPMT RPMW 10T3	5.0	E - RPMT10 - D25Z2W25 - L200	0593	15	25	2	100	200	Weldon	25	-	-	●
		M - RPMT10 - D25Z2M12	0594	15	25	2	-	35	Modular	M12	-	21	●
		M - RPMT10 - D32Z3M16	0595	22	32	3	-	43		M16	-	29	●
RPMT RPMW 1204	6.0	E - RPMT12 - D32Z3W32 - L150	0596	20	32	3	60	150	Weldon	32	-	-	●
		E - RPMT12 - D32Z3W32 - L200	0597	20	32	3	100	200		32	-	-	●
		F - RPMT12 - D50Z4S22	0598	38	50	4	-	50	Shellmill	22	22	42	●
		F - RPMT12 - D52Z5S22	0599	40	52	5	-	50		22	22	42	●
		F - RPMT12 - D63Z5S22	0600	51	63	5	-	50		22	22	48	●
		F - RPMT12 - D80Z6S27	0601	68	80	6	-	50		27	25	58	●
		M - RPMT12 - D32Z3M16	0602	20	32	3	-	43	Modular	M16	-	29	●
		M - RPMT12 - D40Z4M16	0603	28	40	4	-	43		M16	-	29	●

Milling - Profiling - Inserts

RDKT - Profiling Positive (Round)

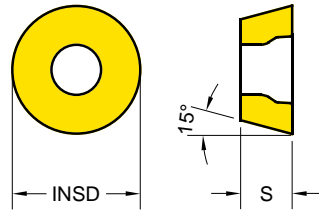

Series	INSD	S
RDK* 0501	5	1.4
RDK* 0702	7	2.4
RDK* 0802	8	2.4
RDK* 10T3	10	4.0
RDK* 1204	12	4.8

EDP 1200..

P25	P30	P20
M30		
K30	K30	
S20		

● : Stock item
○ : Order made item

RDKT		Designation	Fz (mm/tooth)	YG602	YG622	YG712
RDKT General		RDKT 0802M0	0.15 ~ 0.25	● 0035		
		RDKT 10T3M0	0.15 ~ 0.28	● 0041		
		RDKT 1204M0	0.20 ~ 0.30	● 0034		
-ST Stainless Steel Super Alloy		RDKT 0802M0 - ST	0.08 ~ 0.25	● 0292		
		RDKT 10T3M0 - ST	0.08 ~ 0.28	● 0293		
		RDKT 1204M0 - ST	0.10 ~ 0.30	● 0294		
-TR Hardened Steel		RDKT 0802M0 - TR	0.18 ~ 0.35	● 0284	● 0339	
		RDKT 10T3M0 - TR	0.22 ~ 0.40	● 0285	● 0338	
		RDKT 1204M0 - TR	0.22 ~ 0.40	● 0272	● 0340	
RDKW Hard Materials		RDKW 0501M0	0.10 ~ 0.20	● 0207		
		RDKW 0702M0	0.12 ~ 0.25	● 0208		
		RDKW 0802M0	0.13 ~ 0.25	● 0043		
		RDKW 10T3M0	0.16 ~ 0.30	● 0040		
		RDKW 1204M0	0.16 ~ 0.35	● 0042		

Cutting Speed			Vc (m/min.)					
ISO	VDI	Sub Group	YG602		YG622		YG712	
			Min	Max	Min	Max	Min	Max
P	1-5	Non-Alloyed Steel	140	380	140	400	170	300
	6-9	Low-Alloyed Steel	120	300	120	320	180	250
	10-11	High-Alloyed Steel	70	150	70	170	100	140
M	12-13	Ferritic & Martensitic	120	200	-	-	-	-
	14	Austenitic Stainless Steel	130	250	-	-	-	-
K	15-16	Grey Cast Iron	120	250	120	270	-	-
	17-18	Nodular Cast Iron	130	220	130	240	-	-
N	21-30	Non-Ferrous Metals (Al)	-	-	-	-	-	-
S	31-37	Superalloys & Titanium	25	45	-	-	-	-
H	38-41	Hard Materials	40	80	40	100	-	-

RDMT / W- Profiling Positive (Round)

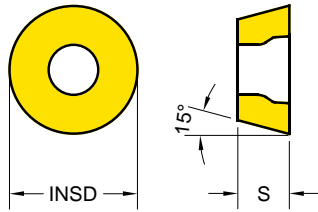

Series	INSD	S
RDMT0802	8	2.38
RDMT0803	8	3.18
RDMT10	10	3.97
RDMT12	12	4.76

EDP 1200..

P25	P30	P20
M30		
K30	K30	
S20		

● : Stock item

○ : Order made item

RDMT RDMW	Designation	Fz (mm/tooth)	YG602	YG622	YG712
RDMT General	RDMT 0802M0	0.15 ~ 0.25	● 0245		
	RDMT 0803M0	0.15 ~ 0.25	● 0225		
	RDMT 10T3M0	0.18 ~ 0.28	● 0246		
	RDMT 1204M0	0.2 ~ 0.3	● 0226		
RDMW Hard Materials	RDMW 0802M0	0.05 ~ 0.15	● 0227		
	RDMW 10T3M0	0.1 ~ 0.25	● 0228		
	RDMW 1204M0	0.16 ~ 0.3	● 0229		

Cutting Speed			Vc (m/min.)					
ISO	VDI	Sub Group	YG602		YG622		YG712	
			Min	Max	Min	Max	Min	Max
P	1-5	Non-Alloyed Steel	140	380	140	400	170	300
	6-9	Low-Alloyed Steel	120	300	120	320	180	250
	10-11	High-Alloyed Steel	70	150	70	170	100	140
M	12-13	Ferritic & Martensitic	120	200	-	-	-	-
	14	Austenitic Stainless Steel	130	250	-	-	-	-
K	15-16	Grey Cast Iron	120	250	120	270	-	-
	17-18	Nodular Cast Iron	130	220	130	240	-	-
N	21-30	Non-Ferrous Metals (Al)	-	-	-	-	-	-
S	31-37	Superalloys & Titanium	25	45	-	-	-	-
H	38-41	Hard Materials	40	80	40	100	-	-

Milling - Profiling - Inserts

RPMT/W - Profiling Positive (Round)

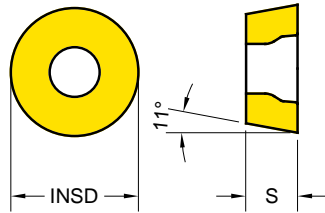



Series	INSD	S
RPMT 08T2	8	2.78
RPMT 10T3	10	3.97
RPMT 1204	12	4.76

EDP 1200..

P25	P30	P20
M30		
K30	K30	
S20		

● : Stock item
○ : Order made item

RPMT	Designation	Fz (mm/tooth)	YG602	YG622	YG712
RPMT General 	RPMT 08T2M0	0.10 ~ 0.24	● 0038		
	RPMT 10T3M0	0.16 ~ 0.30	● 0036		
	RPMT 1204M0	0.20 ~ 0.35	● 0037		● 0415
-ST Stainless Steel Super Alloy 	RPMT 1204M0 - ST	0.10 ~ 0.30	● 0230		
RPMW Hard Materials 	RPMW 1003M0	0.16 ~ 0.30	● 0204		
	RPMW 1204M0	0.16 ~ 0.35	● 0039		

Cutting Speed			Vc (m/min.)					
ISO	VDI	Sub Group	YG602		YG622		YG712	
			Min	Max	Min	Max	Min	Max
P	1-5	Non-Alloyed Steel	140	380	140	400	170	300
	6-9	Low-Alloyed Steel	120	300	120	320	180	250
	10-11	High-Alloyed Steel	70	150	70	170	100	140
M	12-13	Ferritic & Martensitic	120	200	-	-	-	-
	14	Austenitic Stainless Steel	130	250	-	-	-	-
K	15-16	Grey Cast Iron	120	250	120	270	-	-
	17-18	Nodular Cast Iron	130	220	130	240	-	-
N	21-30	Non-Ferrous Metals (Al)	-	-	-	-	-	-
S	31-37	Superalloys & Titanium	25	45	-	-	-	-
H	38-41	Hard Materials	40	80	40	100	-	-

RBEX50 - Profiling / Highfeed (3 Corner)

Series	IC	S
RBEX50	12.7	5.55

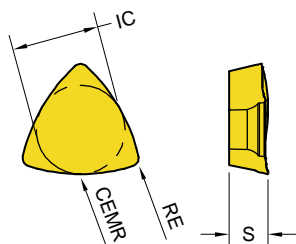

EDP 1200..

P25	P30	P20
M30		
K30	K30	
S20		

● : Stock item

○ : Order made item

RBEX50	Designation	RE (mm)	Fz (mm/tooth)	CEMR (mm)	YG602	YG622	YG712
	RBEX 50	1.2		25	● 0277	● 0443	

RBEX50
General



TURNING

PARTING & GROOVING

MILLING

DRILLING

TECHNICAL INFORMATION

Cutting Speed			Vc (m/min.)					
ISO	VDI	Sub Group	YG602		YG622		YG712	
			Min	Max	Min	Max	Min	Max
P	1-5	Non-Alloyed Steel	140	380	140	400	170	300
	6-9	Low-Alloyed Steel	120	300	120	320	180	250
	10-11	High-Alloyed Steel	70	150	70	170	100	140
M	12-13	Ferritic & Martensitic	120	200	-	-	-	-
	14	Austenitic Stainless Steel	130	250	-	-	-	-
K	15-16	Grey Cast Iron	120	250	120	270	-	-
	17-18	Nodular Cast Iron	130	220	130	240	-	-
N	21-30	Non-Ferrous Metals (Al)	-	-	-	-	-	-
S	31-37	Superalloys & Titanium	25	45	-	-	-	-
H	38-41	Hard Materials	40	80	40	100	-	-

Milling - High Feed Milling - Cutter

Cutters for SDMT, SDMW

Cutting Angle : 10°
4 Corner Positive

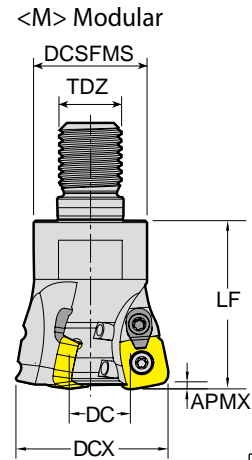
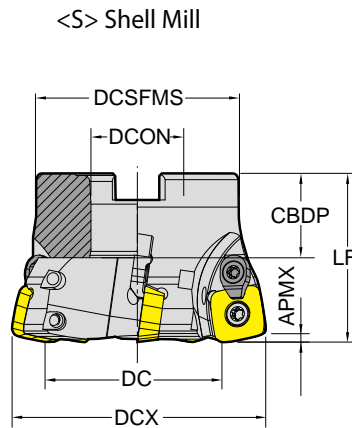

ZAFP : Effective Number of Cutting Edges
CBDP : Connection Bore Depth

□: p.134 unit:mm

Series	APMX	Designation	EDP 1700..	DC	DCX	ZAFP	LF	TYPE	DCON /TDZ	CBDP	DCSFMS	🔹
SDMT SDMW 1204	1.8	FHF - SDMW12 - D50Z4S22	0604	32.4	50	4	40	Shellmill	22	22	42	●
		FHF - SDMW12 - D63Z5S22	0605	45.4	63	5	40		22	22	48	●
		FHF - SDMW12 - D80Z6S27	0606	62.4	80	6	50		27	25	58	●
		FHF - SDMW12 - D100Z8S32	0607	82.4	100	8	50		32	26	65	●
		MHF - SDMW12 - D32Z2M16	0608	14.4	32	2	43	Modular	M16	-	29	●
		MHF - SDMW12 - D40Z3M16	0609	22.4	40	3	43		M16	-	29	●

Technical Information

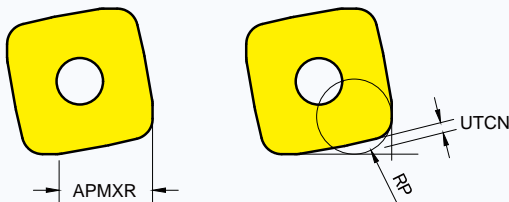

APMXR Radial AP Max	RP Programmed Corner R	UTCN Uncut Thickness
8.6	R3.5	0.94

Milling - High Feed Milling - Inserts SDMT / W - High Feed Positive (4 Corners)

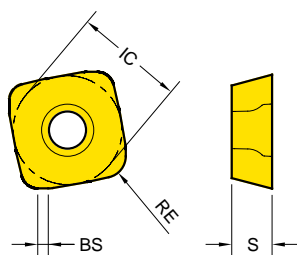

Series	IC	S
SDM* 1204	12.7	4.7

EDP 1200..

P25	P30	P20
M30		
K30	K30	
S20		

● : Stock item

○ : Order made item

SDMT SDMW	Designation	RE (mm)	Fz (mm/tooth)	BS (mm)	YG602	YG622	YG712
-ST Stainless Steel Super Alloy	SDMT 120420-ST	1.9	0.60 ~ 1.20	1.45	● 0274		
SDMW Hard Materials	SDMW 120420	1.9	0.60 ~ 1.40	1.4	● 0273	● 0341	

Cutting Speed			Vc (m/min.)					
ISO	VDI	Sub Group	YG602		YG622		YG712	
			Min	Max	Min	Max	Min	Max
P	1-5	Non-Alloyed Steel	140	380	140	400	170	300
	6-9	Low-Alloyed Steel	120	300	120	320	180	250
	10-11	High-Alloyed Steel	70	150	70	170	100	140
M	12-13	Ferritic & Martensitic	120	200	-	-	-	-
	14	Austenitic Stainless Steel	130	250	-	-	-	-
K	15-16	Grey Cast Iron	120	250	120	270	-	-
	17-18	Nodular Cast Iron	130	220	130	240	-	-
N	21-30	Non-Ferrous Metals (Al)	-	-	-	-	-	-
S	31-37	Superalloys & Titanium	25	45	-	-	-	-
H	38-41	Hard Materials	40	80	40	100	-	-

Milling - Taper Milling - Cutter

Cutters for APKT

2 Corner Positive

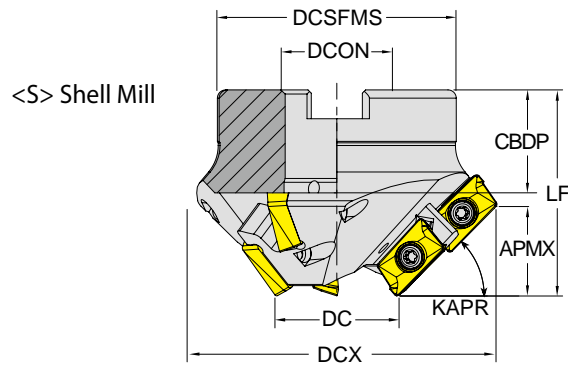

ZEFP : Effective Number of Cutting Edges
 CICT : Number of Inserts
 CDBP : Connection Bore Depth

: p.136 unit:mm

Series	KAPR	APMX	Designation	EDP 1700..	DC	DCX	ZEFP	CICT	LF	TYPE	DCON	CBDP	DCSFMS	
APKT 1604	15	8.0	F15 - APKT16 - D35AP8Z306S27	0630	35	93	3	6	50	Shellmill	27	25	58	●
	45	21.5	F45 - APKT16 - D35AP21Z306S27	0631	35	77	3	6	50		27	25	58	●
	60	26.5	F60 - APKT16 - D35AP26Z306S22	0632	35	65	3	6	50		22	22	48	●
	75	29.5	F75 - APKT16 - D35AP29Z306S22	0633	35	50	3	6	50		22	22	42	●

Milling - Taper Milling - Inserts

APKT - Taper Milling Positive (2 Corner)

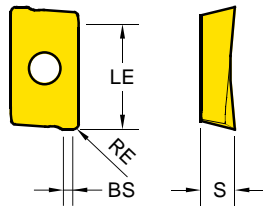

Series	LE	IC	S
APKT 1604	15.2	9.4	5.3

TURNING

PARTING & GROOVING

MILLING

DRILLING

TECHNICAL INFORMATION

APKT	Designation	RE (mm)	Fz (mm/tooth)	BS (mm)	EDP 1200..		
					YG602	YG622	YG712
APKT General	APKT 160408 PDTR	0.8	0.15 ~ 0.30	1.32	● 0001		
-ST Stainless Steel Super Alloy	APKT 160408 - ST	0.8	0.08 ~ 0.25	1.32	● 0270		
-TR Hardened Steel	APKT 160408 - TR	0.8	0.26 ~ 0.40	1.32	● 0256	● 0337	

● : Stock item
○ : Order made item

P25	P30	P20
M30		
K30	K30	
S20		

Cutting Speed			Vc (m/min.)					
ISO	VDI	Sub Group	YG602		YG622		YG712	
			Min	Max	Min	Max	Min	Max
P	1-5	Non-Alloyed Steel	140	380	140	400	170	300
	6-9	Low-Alloyed Steel	120	300	120	320	180	250
	10-11	High-Alloyed Steel	70	150	70	170	100	140
M	12-13	Ferritic & Martensitic	120	200	-	-	-	-
	14	Austenitic Stainless Steel	130	250	-	-	-	-
K	15-16	Grey Cast Iron	120	250	120	270	-	-
	17-18	Nodular Cast Iron	130	220	130	240	-	-
N	21-30	Non-Ferrous Metals (Al)	-	-	-	-	-	-
S	31-37	Superalloys & Titanium	25	45	-	-	-	-
H	38-41	Hard Materials	40	80	40	100	-	-

Milling - Modular Shank

Modular Shanks

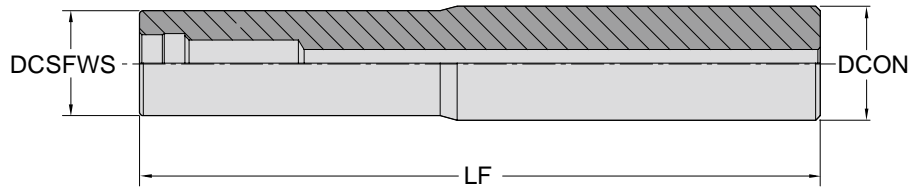

unit:mm

Series	Designation	EDP 1700..	DCSFWS	LF	TYPE	DCON	
M08	EM - M08 - D16ZC16 - L100	0634	16	100	Cylindrical	16	●
	EM - M08 - D16ZC16 - L130	0635	16	130		16	●
M10	EM - M10 - D20ZC20 - L130	0636	20	130	Cylindrical	20	●
M12	EM - M12 - D25ZC25 - L150	0637	25	150	Cylindrical	25	●
	EM - M12 - D25ZC25 - L200	0638	25	200		25	●
	EM - M12 - D25ZC25 - L250	0639	25	250		25	●
M16	EM - M16 - D32ZC32 - L150	0640	32	150	Cylindrical	32	●
	EM - M16 - D32ZC32 - L200	0641	32	200		32	●
	EM - M16 - D32ZC32 - L250	0642	32	250		32	●
	EM - M16 - D32ZC32 - L300	0643	32	300		32	●

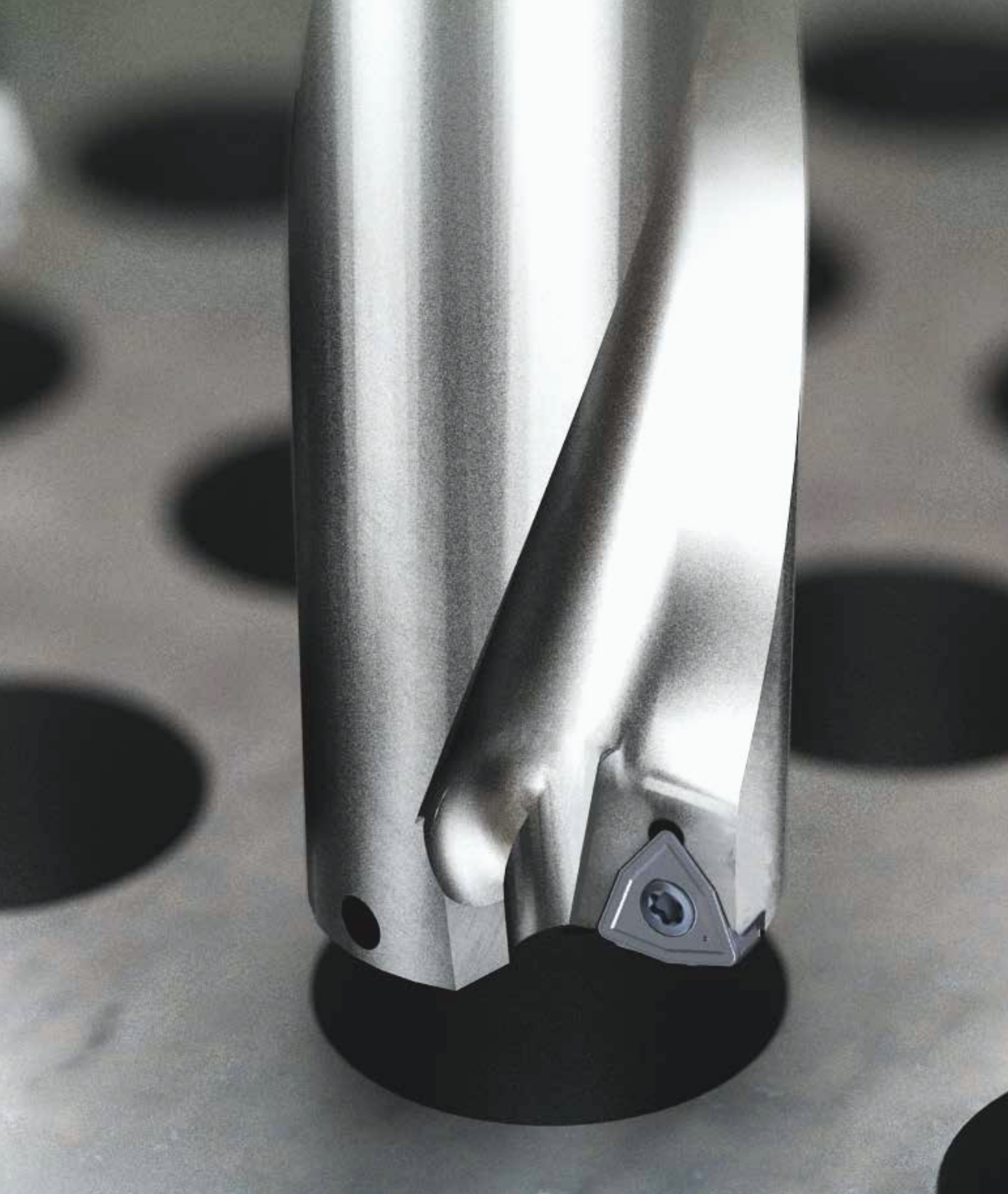

DRILLING

Drilling Overview

Drill Holder

Drilling Inserts (SPMX)

Drilling Inserts (WCMX)

Drilling Overview

Drilling Grades

Drilling Grades		P Steel				M Stainless Steel				K Cast Iron			
		P05	P15	P25	P35	M05	M15	M25	M35	K05	K15	K25	K35
PVD	YG602			602			602					602	

YG602 P20 - P35 M20 - M40 K20 - K40 S15 - S25	PVD - TiAlN 	Universal grade for General Drilling Application <ul style="list-style-type: none"> • Ultra Dense PVD Coating with optimal thermal resistance & strength • Sub-Micron substrate designed for demanding application
--	-----------------	---

Universal Drilling Inserts

	4 Corner	SPMX Series	SPMX	05, 06, 07, 09, 11, 14
	ISO 3 Corner	WCMX Series	WCMX	04, 05, 06, 08

Drilling Chipbreakers

P	M	K		
	M		-ST	<ul style="list-style-type: none"> • Sharp Geometry • Sticky Material, Stainless Steel
P	M	K	General Inserts (No Description)	<ul style="list-style-type: none"> • First Choice for General Application

Drilling - Drill Holder

WCMX 040208 Drill (DC 20~23.5)

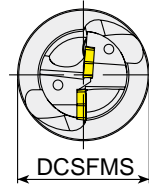
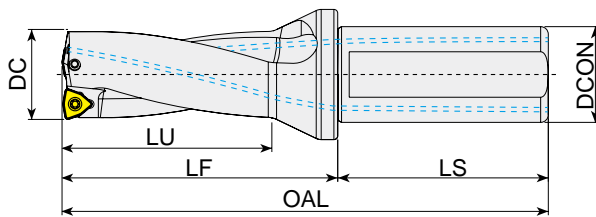

Screw	Wrench
Y3008-M2.5x6	Y80-T08

⊕: p. 147 unit:mm

Series	DC	LU	Designation	EDP 3700..	LF	OAL	DCON	DCSFMS	LS
WCMX 040208	20	40	YGWC2 - 20S25F040 - 04	0257	62	118	25	34	56
		60	YGWC3 - 20S25F060 - 04	0300	82	138			
		80	YGWC4 - 20S25F080 - 04	0343	102	158			
	20.5	40	YGWC2 - 20.5S25F040 - 04	0726	62	118			
		60	YGWC3 - 20.5S25F060 - 04	0727	82	138			
	21	42	YGWC2 - 21S25F042 - 04	0258	64	120			
		63	YGWC3 - 21S25F063 - 04	0301	85	141			
		84	YGWC4 - 21S25F084 - 04	0344	106	162			
	21.5	42	YGWC2 - 21.5S25F042 - 04	0728	64	120			
		63	YGWC3 - 21.5S25F063 - 04	0729	85	141			
	22	44	YGWC2 - 22S25F044 - 04	0259	66	122			
		66	YGWC3 - 22S25F066 - 04	0302	88	144			
		88	YGWC4 - 22S25F088 - 04	0345	110	166			
	22.5	44	YGWC2 - 22.5S25F044 - 04	0730	66	122			
		66	YGWC3 - 22.5S25F066 - 04	0731	88	144			
		88	YGWC4 - 22.5S25F088 - 04	0732	110	166			
	23	46	YGWC2 - 23S25F046 - 04	0260	68	124			
		69	YGWC3 - 23S25F069 - 04	0303	91	147			
		92	YGWC4 - 23S25F092 - 04	0346	114	170			
	23.5	46	YGWC2 - 23.5S25F046 - 04	0733	68	124			
69		YGWC3 - 23.5S25F069 - 04	0734	91	147				

Drilling - Drill Holder

WCMX 050308 Drill (DC 24~29.5)

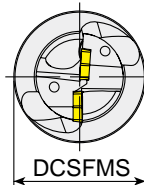
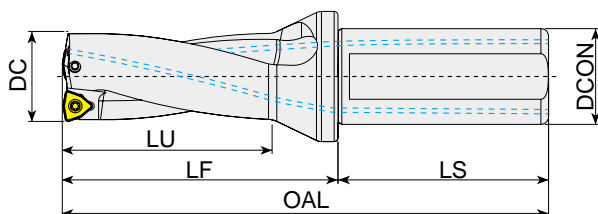

Screw	Wrench
Y3008-M3x8	Y80-T08

: p. 147 unit:mm

Series	DC	LU	Designation	EDP 3700..	LF	OAL	DCON	DCSFMS	LS
WCMX 050308	24	48	YGWC2 - 24S25F048 - 05	0261	70	126	25	34	56
		72	YGWC3 - 24S25F072 - 05	0304	94	150			
		96	YGWC4 - 24S25F096 - 05	0347	118	174			
	24.5	48	YGWC2 - 24.5S25F048 - 05	0735	70	126			
		72	YGWC3 - 24.5S25F072 - 05	0736	94	150			
		50	YGWC2 - 25S25F050 - 05	0262	72	128			
	25	75	YGWC3 - 25S25F075 - 05	0305	97	153			
		100	YGWC4 - 25S25F100 - 05	0251	122	178			
		50	YGWC2 - 25.5S25F050 - 05	0737	72	128			
	25.5	75	YGWC3 - 25.5S25F075 - 05	0738	97	153			
		52	YGWC2 - 26S25F052 - 05	0263	74	130			
		26	78	YGWC3 - 26S25F078 - 05	0306	100			
	104		YGWC4 - 26S25F104 - 05	0349	126	182			
	52		YGWC2 - 26.5S25F052 - 05	0739	74	130			
	26.5	78	YGWC3 - 26.5S25F078 - 05	0741	100	156			
		104	YGWC4 - 26.5S25F104 - 05	0742	126	182			
		54	YGWC2 - 27S25F054 - 05	0264	76	132			
	27	81	YGWC3 - 27S25F081 - 05	0307	103	159			
		108	YGWC4 - 27S25F108 - 05	0350	130	186			
		54	YGWC2 - 27.5S25F054 - 05	0743	76	132			
	27.5	81	YGWC3 - 27.5S25F081 - 05	0744	103	159			
		56	YGWC2 - 28S25F056 - 05	0265	78	134			
		28	84	YGWC3 - 28S25F084 - 05	0308	106			
	112		YGWC4 - 28S25F112 - 05	0351	134	190			
56	YGWC2 - 28.5S25F056 - 05		0745	78	134				
28.5	84	YGWC3 - 28.5S25F084 - 05	0746	106	162				
	112	YGWC4 - 28.5S25F112 - 05	0747	134	190				
	58	YGWC2 - 29S25F058 - 05	0266	80	136				
29	87	YGWC3 - 29S25F087 - 05	0309	109	165				
	116	YGWC4 - 29S25F116 - 05	0352	138	194				
	58	YGWC2 - 29.5S25F058 - 05	0748	80	136				
29.5	87	YGWC3 - 29.5S25F087 - 05	0749	109	165				

Drilling - Drill Holder

WCMX 06T308 Drill (DC 30~44.5)

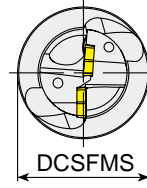
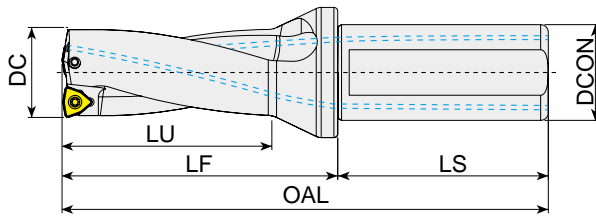

Screw	Wrench
Y3010-M3.5x9	Y80-T10

⊕: p.147 unit:mm

Series	DC	LU	Designation	EDP 3700..	LF	OAL	DCON	DCSFMS	LS
WCMX 06T308	30	60	YGWC2 - 30S32F060 - 06	0267	87	147	32	44	60
		90	YGWC3 - 30S32F090 - 06	0310	117	177			
		120	YGWC4 - 30S32F120 - 06	0353	147	207			
	30.5	90	YGWC3 - 30.5S32F090 - 06	0750	117	177			
	31	62	YGWC2 - 31S32F062 - 06	0268	89	149			
		93	YGWC3 - 31S32F093 - 06	0311	120	180			
		124	YGWC4 - 31S32F124 - 06	0354	151	211			
	31.5	93	YGWC3 - 31.5S32F093 - 06	0751	120	180			
	32	64	YGWC2 - 32S32F064 - 06	0269	91	151			
		96	YGWC3 - 32S32F096 - 06	0312	123	183			
		128	YGWC4 - 32S32F128 - 06	0252	155	215			
	32.5	96	YGWC3 - 32.5S32F096 - 06	0752	123	183			
	33	66	YGWC2 - 33S32F066 - 06	0753	93	153			
		99	YGWC3 - 33S32F099 - 06	0754	126	186			
		132	YGWC4 - 33S32F132 - 06	0755	159	219			
	33.5	99	YGWC3 - 33.5S32F099 - 06	0756	126	186			
		132	YGWC4 - 33.5S32F132 - 06	0757	159	219			
	34	68	YGWC2 - 34S32F068 - 06	0271	95	155			
		102	YGWC3 - 34S32F102 - 06	0314	129	189			
	34.5	136	YGWC4 - 34S32F136 - 06	0357	163	223			
		102	YGWC3 - 34.5S32F102 - 06	0758	129	189			
	35	70	YGWC2 - 35S32F070 - 06	0272	97	157			
		105	YGWC3 - 35S32F105 - 06	0315	132	192			
		140	YGWC4 - 35S32F140 - 06	0358	167	227			
35.5	105	YGWC3 - 35.5S32F105 - 06	0759	132	192				
	72	YGWC2 - 36S32F072 - 06	0273	99	159				
36	108	YGWC3 - 36S32F108 - 06	0316	135	195				
	144	YGWC4 - 36S32F144 - 06	0359	171	231				
36.5	108	YGWC3 - 36.5S32F108 - 06	0760	135	195				
	74	YGWC2 - 37S32F074 - 06	0274	101	161				
37	111	YGWC3 - 37S32F111 - 06	0317	138	198				
	148	YGWC4 - 37S32F148 - 06	0360	175	235				

▶ NEXT PAGE

Drilling - Drill Holder

WCMX 06T308 Drill (DC 30~44.5)

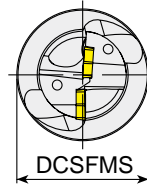
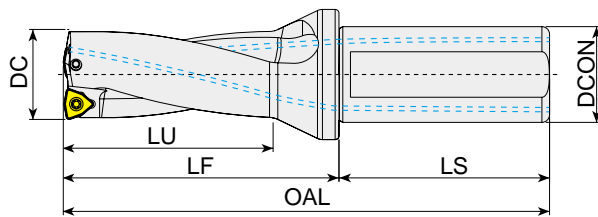

Screw	Wrench
Y3010-M3.5x9	Y80-T10

: p. 147 unit:mm

Series	DC	LU	Designation	EDP 3700..	LF	OAL	DCON	DCSFMS	LS
WCMX 06T308	37.5	111	YGWC3 - 37.5S32F111 - 06	0761	138	198	32	44	60
		76	YGWC2 - 38S32F076 - 06	0275	103	163			
	38	114	YGWC3 - 38S32F114 - 06	0318	141	201			
		152	YGWC4 - 38S32F152 - 06	0361	179	239			
	38.5	114	YGWC3 - 38.5S32F114 - 06	0762	141	201			
		152	YGWC4 - 38.5S32F152 - 06	0763	179	239			
	39	78	YGWC2 - 39S32F078 - 06	0276	105	165			
		117	YGWC3 - 39S32F117 - 06	0319	144	204			
	39.5	156	YGWC4 - 39S32F156 - 06	0362	183	243			
		117	YGWC3 - 39.5S32F117 - 06	0764	144	204			
	40	80	YGWC2 - 40S32F080 - 06	0277	107	167			
		120	YGWC3 - 40S32F120 - 06	0320	147	207			
	40.5	160	YGWC4 - 40S32F160 - 06	0363	187	247			
		120	YGWC3 - 40.5S32F120 - 06	0765	147	207			
	41	82	YGWC2 - 41S32F082 - 06	0278	109	169			
		123	YGWC3 - 41S32F123 - 06	0321	150	210			
	41.5	164	YGWC4 - 41S32F164 - 06	0364	191	251			
		123	YGWC3 - 41.5S32F123 - 06	0766	150	210			
	42	84	YGWC2 - 42S32F084 - 06	0279	111	171			
		126	YGWC3 - 42S32F126 - 06	0322	153	213			
	42.5	168	YGWC4 - 42S32F168 - 06	0365	195	255			
		126	YGWC3 - 42.5S32F126 - 06	0767	153	213			
	43	86	YGWC2 - 43S32F086 - 06	0280	113	173			
		129	YGWC3 - 43S32F129 - 06	0323	156	216			
	43.5	172	YGWC4 - 43S32F172 - 06	0366	199	259			
		129	YGWC3 - 43.5S32F129 - 06	0768	156	216			
	44	88	YGWC2 - 44S32F088 - 06	0281	115	175			
		132	YGWC3 - 44S32F132 - 06	0324	159	219			
44.5	176	YGWC4 - 44S32F176 - 06	0367	203	263				
	132	YGWC3 - 44.5S32F132 - 06	0769	159	219				

Drilling - Drill Holder

WCMX 080412 Drill (DC 45~60)

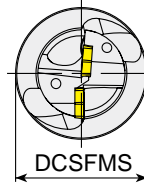
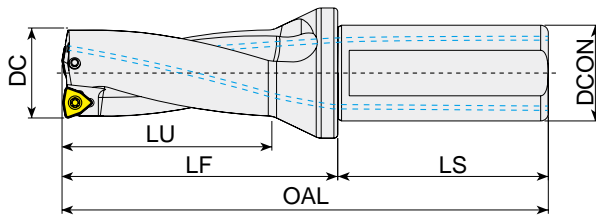

Screw	Wrench
Y4015-M4x11	Y80-T15

⊕: p. 147 unit:mm

Series	DC	LU	Designation	EDP 3700..	LF	OAL	DCON	DCSFMS	LS
WCMX 080412	45	90	YGWC2 - 45S40F090 - 08	0282	122	192	40	54	70
		135	YGWC3 - 45S40F135 - 08	0325	167	237			
		180	YGWC4 - 45S40F180 - 08	0368	212	282			
	45.5	135	YGWC3 - 45.5S40F135 - 08	0770	167	237			
	46	92	YGWC2 - 46S40F092 - 08	0283	124	194			
		138	YGWC3 - 46S40F138 - 08	0326	170	240			
		184	YGWC4 - 46S40F184 - 08	0369	216	286			
	47	94	YGWC2 - 47S40F094 - 08	0284	126	196			
		141	YGWC3 - 47S40F141 - 08	0327	173	243			
		188	YGWC4 - 47S40F188 - 08	0370	220	290			
	48	96	YGWC2 - 48S40F096 - 08	0285	128	198			
		144	YGWC3 - 48S40F144 - 08	0328	176	246			
		192	YGWC4 - 48S40F192 - 08	0371	224	294			
	49	98	YGWC2 - 49S40F098 - 08	0286	130	200			
		147	YGWC3 - 49S40F147 - 08	0329	179	249			
		196	YGWC4 - 49S40F196 - 08	0372	228	298			
	50	100	YGWC2 - 50S40F100 - 08	0287	132	202			
		150	YGWC3 - 50S40F150 - 08	0330	182	252			
		200	YGWC4 - 50S40F200 - 08	0373	232	302			
	51	102	YGWC2 - 51S40F102 - 08	0288	134	204			

▶ NEXT PAGE

Drilling - Drill Holder

WCMX 080412 Drill (DC 45~60)

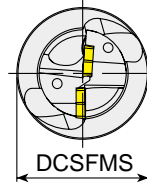
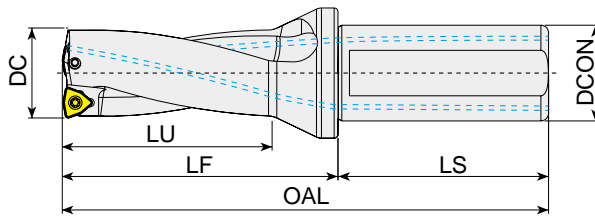

Screw	Wrench
Y4015-M4x11	Y80-T15

: p. 147 unit:mm

Series	DC	LU	Designation	EDP 3700..	LF	OAL	DCON	DCSFMS	LS
WCMX 080412	51	153	YGWC3 - 51S40F153 - 08	0331	185	255	40	54	70
	52	104	YGWC2 - 52S40F104 - 08	0289	136	206			
		156	YGWC3 - 52S40F156 - 08	0332	188	258			
	53	106	YGWC2 - 53S40F106 - 08	0290	138	208			
		159	YGWC3 - 53S40F159 - 08	0333	191	261			
	54	108	YGWC2 - 54S40F108 - 08	0291	140	210			
		162	YGWC3 - 54S40F162 - 08	0334	194	264			
	55	110	YGWC2 - 55S40F110 - 08	0292	142	212			
		165	YGWC3 - 55S40F165 - 08	0335	197	267			
	56	112	YGWC2 - 56S40F112 - 08	0293	144	214			
		168	YGWC3 - 56S40F168 - 08	0336	200	270			
	57	114	YGWC2 - 57S40F114 - 08	0294	146	216			
		171	YGWC3 - 57S40F171 - 08	0337	203	273			
	58	116	YGWC2 - 58S40F116 - 08	0295	148	218			
		174	YGWC3 - 58S40F174 - 08	0338	206	276			
	59	118	YGWC2 - 59S40F118 - 08	0771	150	220			
		177	YGWC3 - 59S40F177 - 08	0772	209	279			
	60	120	YGWC2 - 60S40F120 - 08	0773	152	222			
		180	YGWC3 - 60S40F180 - 08	0774	212	282			

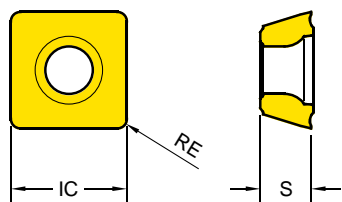

Drilling - Inserts

Drilling Inserts (SPMX)



Series	Metric	
	IC	S
SPMX 0502	5.00	2.38
SPMX 0602	6.00	2.41
SPMX 07T3	7.94	3.97
SPMX 0904	9.80	4.30
SPMX 1104	11.50	4.90
SPMX 1405	14.30	5.30

EDP 3200..

SPMX		Designation	Fn (mm/rev.)	YG602
SPMX General		SPMX 050204	0.07 ~ 0.14	● 0005
		SPMX 060204	0.08 ~ 0.14	● 0006
		SPMX 07T308	0.08 ~ 0.16	● 0007
		SPMX 090408	0.08 ~ 0.16	● 0008
		SPMX 110408	0.10 ~ 0.18	● 0009
		SPMX 140512	0.10 ~ 0.20	● 0010
-ST Stainless Steel		SPMX 050204 - ST	0.03 ~ 0.10	● 0011
		SPMX 060204 - ST	0.04 ~ 0.11	● 0012
		SPMX 07T308 - ST	0.04 ~ 0.11	● 0013
		SPMX 090408 - ST	0.05 ~ 0.12	● 0014

Cutting Speed			Vc (m/min.)	
ISO	VDI	Sub Group	YG602	
			Min	Max
P	1-5	Non-Alloyed Steel	140	380
	6-9	Low-Alloyed Steel	120	300
	10-11	High-Alloyed Steel	70	150
M	12-13	Ferritic & Martensitic	120	200
	14	Austenitic Stainless Steel	130	250
K	15-16	Grey Cast Iron	120	250
	17-18	Nodular Cast Iron	130	220

Drilling - Inserts

Drilling Inserts (WCMX)

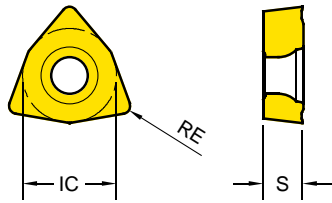

Series	Metric	
	IC	S
WCMX 0402	6.35	2.38
WCMX 0503	7.94	3.18
WCMX 06T3	9.53	3.97
WCMX 0804	12.70	4.76

WCMX	Designation	Fn (mm/rev.)	EDP 3200..
			YG602
WCMX General 	WCMX 040208	0.05 ~ 0.11	● 0003
	WCMX 050308	0.06 ~ 0.14	● 0001
	WCMX 06T308	0.08 ~ 0.14	● 0002
	WCMX 080412	0.08 ~ 0.14	● 0004

Cutting Speed			Vc (m/min.)	
ISO	VDI	Sub Group	YG602	
			Min	Max
P	1-5	Non-Alloyed Steel	140	380
	6-9	Low-Alloyed Steel	120	300
	10-11	High-Alloyed Steel	70	150
M	12-13	Ferritic & Martensitic	120	200
	14	Austenitic Stainless Steel	130	250
K	15-16	Grey Cast Iron	120	250
	17-18	Nodular Cast Iron	130	220

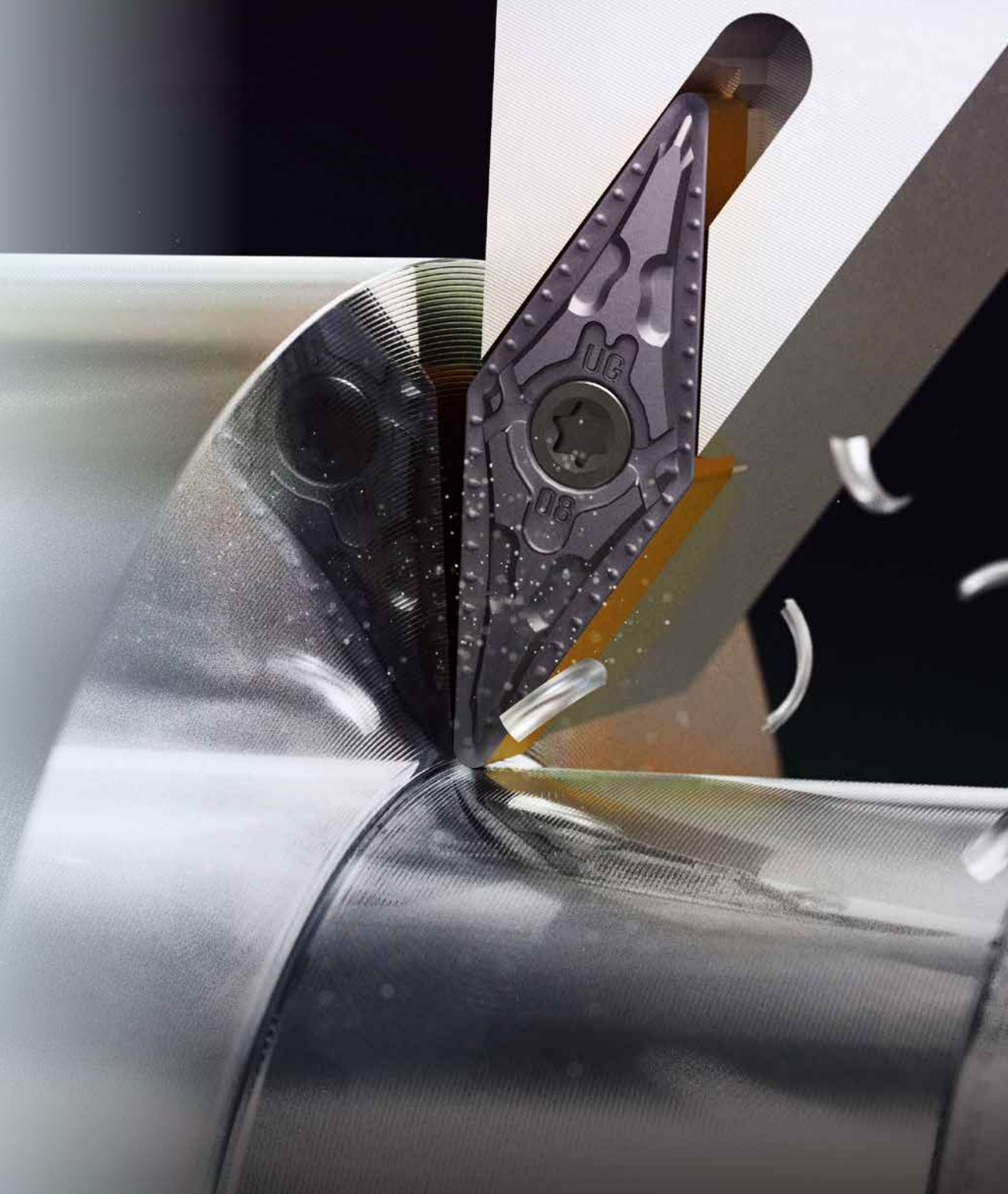

TECHNICAL INFORMATION

ISO 13399 Terms
Hardness Conversion Table
Material Groups
Comparison Chart
Search

Technical Information

ISO 13399 Terms

AN	Clearance angle major	INSD	Insert diameter
APMX	Depth of cut maximum	KAPR	Tool cutting edge angle
AS	Clearance angle wiper edge	KRINS	Cutting edge angle major
B	Shank width	KWW	Keyway width
BS	Wiper edge length	L	Cutting edge length
CBDP	Connection bore depth	LE	Cutting edge effective length
CDX	cutting depth maximum	LF	Functional length
CICT	Number of Inserts	LH	Head length
CW	Cutting width	LS	Shank length
CZC	Connection size code	LU	Usable length
DC	Cutting diameter	LUX	Usable length maximum
DCON	Connection diameter	M	Nose (or Wiper) Height
DCSFMS	Contact surface diameter machine side	OAL	Overall length
DCX	Cutting diameter maximum	RE	Corner radius
DMIN	Minimum bore diameter	RMPX	Maximum ramping angle
DMM	Shank diameter	RPMX	Rotational speed maximum
EPSR	Insert included angle	S	Insert thickness
H	Shank height	TDZ	Thread diameter size
HAND	Hand	WF	Functional width
IC	Inscribed circle diameter	ZEFP	Peripheral effective cutting edge count

Technical Information

Hardness Conversion Table

	HB	HRC	HRB	HV	N/mm ²
TURNING	199	15	93	199	667
	203	16	94	201	680
	208	17	95	210	696
	212	18	95	218	706
	216	19	96	222	716
	223	20	97	227	755
PARTING & GROOVING	229	21	98	235	775
	233	22	99	241	794
	240	23	100	247	824
	245	24	100	252	838
	250	25	101	255	853
	255	26	102	258	870
	262	27	103	262	880
	264	28	103	271	892
	271	29	104	277	941
	277	30	105	285	971
MILLING	290	31	106	292	990
	300	32	107	303	1020
	308	33	107	311	1035
	314	34	108	320	1049
	322	35	108	332	1089
	331	36	109	342	1118
	341	37	109	351	1157
	348	38	110	361	1187
	360	39	111	376	1236
	373	40	111	388	1265
DRILLING	375	41	112	393	1314
	388	42	113	406	1363
	402	43	114	424	1390
	415	44	114	438	1422
	419	45	114	448	1447
	430	46	115	458	1471
	445	47	115	474	1520
	456	48	116	490	1569
	468	49	117	497	
	469	50	117	505	
	486	51	118	531	
	504	52	118	549	
	513	53	119	567	
	534	54	120	589	
	552	55		649	
	572	56		694	
592	57		727		
601	58		746		
613	59				
627	60				
642	61				
658	62				
681	63				
695	64				
	HB	HRC	HRB	HV	N/mm ²

Technical Information

Material Groups

Please visit
globalyg1.com/mat
 for material search



ISO	VDI 3323	Material Description	Composition / Structure / Heat Treatment		HB	HRc	Examples	Page	
P	1	Non-alloyed steel	About 0.15% C	Annealed	125		S15C, C15, 1015	152	
	2		About 0.45% C	Annealed	190	13	S45C, C45, 1045		
	3		About 0.45% C	Quenched & tempered	250	25			
	4		About 0.75% C	Annealed	270	28			
	5	About 0.75% C	Quenched & Tempered	300	32	SK5, Ck75, 1080			
	6	Low-alloyed Steel		Annealed	180	10	SCM440, 42CrMo4, 410		
	7			Quenched & Tempered	275	29			
	8			Quenched & Tempered	300	32			
	9		Quenched & Tempered	350	38				
	10	High-alloyed steel, and tool steel		Annealed	200	15	SKD, D2		
	11			Quenched & Tempered	325	35	SKH, SUH, M42		
M	12	Stainless Steel	Ferritic / Martensitic	Annealed	200	15	SUS 420, X40Cr13, 420	159	
	13		Martensitic	Quenched & Tempered	240	23			
	14		Austenitic		180	10	SUS 316, 316, X5CrNiMo 17 12 2		
K	15	Grey cast iron	Pearlitic / Ferritic		180	10	FC, GG, EN-GJL-250	161	
	16		Pearlitic (Martensitic)		260	26			
	17	Nodular cast iron	Ferritic		160	3	FCD, GGG, EN-GJS-500-7		
	18		Pearlitic		250	25			
	19	Malleable cast iron	Ferritic		130		FCMW, FCMP, GTS, GJMB350-10		
	20		Pearlitic		230	21			
N	21	Aluminum-wrought alloy	Not Curable		60		SAE 1000, AlMg 1, 3.3315	163	
	22		Curable	Hardened	100		SAE 7050, AlCuMg 1, 3.1325		
	23	Aluminum-cast, alloyed	≤ 12% Si, Not Curable		75		ADC12, G-AlSi12, 3.2581		
	24		≤ 12% Si, Curable	Hardened	90		C4BS, G-AlSi10Mg, 3.2381		
	25		> 12% Si, Not Curable		130				
	26		Cutting Alloys, PB>1%		110		CuZn36Pb 3, 2.0375		
	27	Copper and copper alloys (Bronze / Brass)	CuZn, CuSnZn (Brass)		90		CuZn 15, 2.0240		
	28		CuSn, lead-free copper and electrolytic copper		100		G-CuZn40Fe, 2.0590		
	29	Non-metallic materials	Duroplastic, Fiber Reinforced Plastic				CFRP		
	30		Rubber, Wood, etc.						
S	31	Heat resistant super alloys	Fe Based	Annealed	200	15	X12 NiCrSi 36-16, 1.4864	165	
	32			Aged	280	30			
	33			Annealed	250	25			Inconel 718, NiCr20TiAl, 2.4631
	34		Ni or Co Based	Aged	350	38			NiCu30Al, 2.4375
	35			Cast	320	34			G-X120Mn12, 1.3401
	36	Titanium alloys	Pure Titanium		400 Rm				
37	Alpha + Beta Alloys		Hardened	1050Rm		TiAl6V4, 3.7165			
H	38	Hardened steel		Hardened	550	55	SK3	167	
	39			Hardened	630	60			
	40	Chilled cast iron		Cast	400	42			
	41	Hardened cast iron		Hardened	550	55			

Technical Information

Material Groups

Please visit
globalyg1.com/mat
 for material search



P	VDI 3323 1		Material Description Non-alloyed steel			Composition / Structure / Heat Treatment About 0.15% C, Annealed					HB 125	HRC	
	Mat'l No.	JIS	DIN	AISI/ASTM/SAE	BS	EN	AFNOR	SS	UNI	UNE / IHA	UNS	GOST	Brands
1.0037	STKM 12 C	St 37-2	-	4360 40 B	S235JR	E24-2	1311	Fe 360 B				16D	
1.0038	STKM 12 A	St 37-3	A570.36	4360 40 C	S275J2G3	E28-3	1312	Fe 360 D FF				ST14KP	
1.0045	SM 490 YA	S 355 JR	-	-	S 1207	E36-2	-	Fe 510 BFN					
1.0050	SS 50	St 50-2	A570 Gr.50	4360 50 B	E 295	A50-2	2172	Fe 490				ST5PS	
1.0060	SM 58	St 60-2	A572 Gr.65	4360 55 E	-	A60-2	1650	Fe 60-2				ST6PS	
1.0114		S 235 J0	-	En 40C	S 235 J0	E24-3		Fe 360 CFN					
1.0143		S 275 J0	-	-	S 275 J0	E28-3	1414	Fe 430 C					
1.0144	SM41C, SM400	St 44-3 N	A573 Gr. 81	4360 43C	S275 J2G3	E28-3	1412	Fe 430 D FF				ST14KP	
1.0149		Ro St 44-2	-	43C	S 275 J0 H	-	1412	Fe430C					
1.0301	S10C	C10	1010	045M10	C10	34C10, XC10		C10	F.1511	G10100	10		
1.0330	SPCC	St 12	-	DC 01	Fe P01	DC 01/Fe P01	1142	Fe P01				15KP	
1.0335	SPHE	DD 13 (StW 24)	A622(1008)	H S 3	DD 13	3C		FeP13				08KP	
1.0338	SPCE	St 4	A620(1008)	14491CR	Fe P04	Fe 14	1147	DC04/FeP04				08JU	
1.0345	SPV 50	P235 GH	A516 Gr.65	P 235 GH	P 235 GH	A 37 CP	1330	Fe E 235		K02503			
1.0401	S15C	C15	1015	080M15	-	C18RR, XC18	1350	C15, C16	F.1110	G10170	15		
1.0402	S20C	C22	1020	050 A 20	1 C 22	C20	1450	C 20	F.1120	G10200	20		
1.0425	SPV315	P265GH/HII				A42CP	1430	Fe4101KW		K02801	16K		
1.0443	SC 450	G5-45	A2765-35	A1		E23-45M	1305						
1.0539		S355NH				TSE355-4	2134	Fe510B					
1.0545		S355N		4360-50E		E355R	2334	FeE355KG					
1.0546		S355NL		4360-50EE		E355FP	2135	FeE355KT					
1.0547		S355J0H		4360-50C		TSE355-3	2172	Fe510C					
1.0549		S355NLH					2135	Fe510D					
1.0553	SM 520 M	St52-3U	A14880-40	4360-50C		320-560M	1606	Fe510C					
1.0562	SM490A	St E 355	A633 Gr.C	P 355 N		FeE355KGN	2132	Fe E 355 KG		K12000	15GF		
1.0565		W St E 355		P 355 NH		P 355 NH	2106	Fe E 355 KW		K01600			
1.0566	SLA 37	T St E 355		P 355 NL1		P 355 NL1	2107	Fe E 355 KT					
1.0570	SM 50 YA	St 52-3	1	4360-50 C	S355JR	E36-3	2172	Fe 510 B				17G1S	
1.0715	SUM22	9SMn28	1213	230M07		S250	1912	CFSMn28	F.2111	G12130			
1.0718	SUM22L	9SMnPb28	12L13			S250Pb	1914	CF9SMnPb28	F.2112	G12134			
1.0721		10S20	1108	10S20		10S20		CF10S20	F.2121	G11080			
1.0722		10SPb20	11L08			10PbF2		CF10SPb20		G11084			
1.0736	SUM25	9SMn36	1215			S300		CF9Mn36	F.2113	G12150			
1.0737		9SMnPb36	12L14			S300Pb	1926	CF9SMnPb36	F.2114	G12144			
1.0972		S315MC		1501-40F30		E315D							
1.0976		S355MC		1501-43F35		E355D	2642	FeE355TM					
1.0982		S460MC		1501-50F45									
1.0984		S500MC				E490D	2662	FeE490TM					
1.0986		S500MC		1501-60F55		E560D		FeE560TM					
1.1121	S10C	Ck10	1010	040A10		XC10	1265	C10	F.1510	G10100	10		
1.1141	S15	Ck15	1015	040A15	32C	XC15	1370	C15	F.1110	G10150	15		
1.1151	S20C	C22E	1020	055M15		2C22	1450	C20	F.1120	G10230	20		
1.8900	S25C	StE380	A572-60	436055E			2145	FeE390KG					
		St44-2	A36	436043A		NFA35-501E28	1411						
		StE320-3Z		1501160			1421						

Technical Information

Material Groups

Please visit
globalyg1.com/mat
 for material search



Mat'l No.	JIS	DIN	Material Description			Composition / Structure / Heat Treatment					HB	HRC
			AISI/ASTM/SAE	BS	EN	AFNOR	SS	UNI	UNE / IHA	UNS	GOST	Brands
<div style="display: flex; justify-content: space-between; align-items: center;"> <div style="font-size: 2em; font-weight: bold; color: #0070C0;">P</div> <div style="text-align: center;"> VDI 3323 2 </div> <div style="text-align: center;"> Material Description Non-alloyed steel </div> <div style="text-align: center;"> Composition / Structure / Heat Treatment About 0.45% C, Annealed </div> <div style="text-align: center;"> HB 190 </div> <div style="text-align: center;"> HRC 13 </div> </div>												
1.0501	S35C	C35	1035	080A32		1C35	1572	C35	F.113	G10350	35	
1.0503	S45C	C45	1045	060A47		XC42H1TS	1672	C45	F.114	G10450	45	
1.0511	S40C	C40	1040	080M40		1C40		C40	F.114.A	G10400	40	
1.0540	S 50 C	C50					1674	C50		G10500		
1.0551		GS-52	A2770-36	A2		280-480M	1505					
1.0553	SM 520 M	S52-3U	A14880-40	4360-50C		320-560M	1606	Fe510C				
1.0577		S355 J2 G 4	A738	Fe 510 D 2 FF		A52FP	2107					
1.0726		35S20	1140	212M36	8M	35MF6	1957			G11400	40	
1.0727		45S20	1146			45MF4	1973			G11460		
1.1157		40Mn4	1039	150M36	15	40M5				G10390	40G	
1.1158	S25C	C25E	1025	070M25		XC25		C25	F.1120	G10250	25	
1.1166	SMn433H	34Mn5	1536						TO.B	G15360		
1.1167	SMn438(H)	36Mn5	1335	150M36		40M5	2120	36Mn6	F.1203	G13350	35G2	
1.1170	SCMn1	28Mn6	1330	150M28	14A	20M5		C28Mn	28Mn6	G13300	30G	
1.1178	S 30 C	C30E		080M30		XC32		C30	2C30	G10300		
1.1180		C35R	1035	080A35		3C35	1572		F.1135	G10350		
1.1181	S35C	C35E	1035	080A35		XC38	1572	C36	F.1130	G10340	35	
1.1191	S45C	Ck45	1045	080A46		XC45	1672	C45	F.1140		45	
1.1206	S 50 C	C50E	1050	080M50		2C50	1674	C50		G10500	50	
1.1213	S50C	Cf53	1050	070M55		XC48HTS	1674	C53		G10500	50	

Mat'l No.	JIS	DIN	Material Description			Composition / Structure / Heat Treatment					HB	HRC
			AISI/ASTM/SAE	BS	EN	AFNOR	SS	UNI	UNE / IHA	UNS	GOST	Brands
<div style="display: flex; justify-content: space-between; align-items: center;"> <div style="font-size: 2em; font-weight: bold; color: #0070C0;">P</div> <div style="text-align: center;"> VDI 3323 3 </div> <div style="text-align: center;"> Material Description Non-alloyed steel </div> <div style="text-align: center;"> Composition / Structure / Heat Treatment About 0.45% C, Annealed </div> <div style="text-align: center;"> HB 250 </div> <div style="text-align: center;"> HRC 25 </div> </div>												
1.0481	SG365	17 Mn 4/P 295 GH	A516 Gr. 70	224-460B	P 295 GH	A 48 CP	2102	Fe E 295	A47RC1	K03501	14G2	
1.0501	S35C	C35	1035	080A32		1C35	1572	C35	F.1130	G10350	35	
1.0503	S45C	C45	1045	060A47		XC42H1TS	1672	C45	F.1140	G10450	45	
1.0614		C76D	1074			XC75				G10750		
1.0616		C86D	1086			XC80		C85		G10860		
1.0618		C92D	1095			XC90				G10950		
1.0726		35S20	1140	212M36	8M	35MF6	1957			G11400	40	
1.1157		40Mn4	1039	150M36	15	40M5				G10390	40G	
1.1165	SMn433H	30Mn5	1036	120M36		35M5		30Mn5	F.8211	K13300	30G2	
1.1167	SMn438(H)	36Mn5	1335	150M36		40M5	2120	36Mn6	F.1203	G13350	35G2	
1.1186	S40C	C40E	1040	060A40		2C40		C40		G10400		
1.1191	S45C	Ck45	1045	080M46		2C45	1672	C45	F.1140		45	
1.1201	S50C	C45R	1049	080M46		3C45	1660	C45	F.1145		38HM	
1.1213	S50C	Cf53	1050	070M55		XC48HTS	1674	C53		G10500	50	
1.7242	SCM418 H	18CrMo4										
1.7337		16CrMo4-4	A387 Gr.12					A18CrMo45KW		K11564	15C M	
1.7362	SCMV 6	12CrMo195		3606-625		Z10CD5-05		16CrMo205		K41545		
		17MnV6	A572-60	436055E		NFA35-501E36	2142					

Technical Information

Material Groups

Please visit
global.yg1.com/mat
 for material search



Mat'l No.	JIS	DIN	Material Description			Composition / Structure / Heat Treatment					HB	HRC	
			AISI/ASTM/SAE	BS	EN	AFNOR	SS	UNI	UNE / IHA	UNS	GOST	Brands	
		P	VDI 3323	Material Description			Composition / Structure / Heat Treatment					HB	HRC
			4	Non-alloyed steel			About 0.75% C, Annealed					270	28
1.0603	S 70 C-CSP	C67	107	080A67		XC65		C67		G10700			
1.0605		C75	1075	144980HS				C75		G10740	75		
1.1203	S55C	Ck55	1055	060A57		2C55	1655	C55	F.1150	G10550	55		
1.1209		C55R	1055	070M55		3C55		C55	F.1155	G10550			
1.1221	S58C	Ck60	1060	060A62	43D	2C60	1678	C60	F.1150	G10640	60		
1.1231	S 70 C-CSP	C67E	1070	060A67		XC68	1770	C70	F5103	G10700	65GA		
1.1248	C 75	C75E	1074	060A78		XC75	1774	C75	F5107	G10800	75(A)		
1.1269	SK 5 -CSP	C85E	1086			XC90		C90		G10900	85(A)		
1.1274	SUP4	Ck 101	1095	060 A 96	C 100S	XC100	1870	C100	F5117	G10950			
1.1545	SK 3	C 105W1	W1	BW 2	C 105U	Y1 105	1880	C 100 KU	F5118		U10A		
1.1663	SK 2	C125W	W112			Y2120					U13		

Mat'l No.	JIS	DIN	Material Description			Composition / Structure / Heat Treatment					HB	HRC	
			AISI/ASTM/SAE	BS	EN	AFNOR	SS	UNI	UNE / IHA	UNS	GOST	Brands	
		P	VDI 3323	Material Description			Composition / Structure / Heat Treatment					HB	HRC
			5	Non-alloyed steel			About 0.75% C, Quenched & Tempered					300	32
1.0070		St 70-2	1055	Fe690-2FN	-	A70-2	1655	Fe 690	F.1150		55		
1.0535	S55C	C55	1055	070M55		1C55	1655	C55		J05000	55		
1.0601	S58C	C60	1060	060A62	43D	1C60		C60		G10600	60(G)		
1.1203	S55C	Ck55	1055	060A57		2C55	1655	C55	F.1150	G10550	55		
1.1221	S58C	Ck60	1060	060A62	43D	2C60	1678	C60	F.1150	G10640	60		
1.1274	SUP4	Ck 101	1095	060 A 96	C 100S	XC100	1870	C100	F5117	G10950			
1.1545	SK 3	C 105W1	W1	BW 2	C 105U	Y1 105	1880	C 100 KU	F5118		U10A		
1.1663	SK 2	C125W	W112			Y2120					U13		
1.5120		38MnSi4											
1.5710	SNC236	36NiCr6	3135	640A35	111A	35NC6							
1.7701		51CrMoV4						51CrMoV4					

Technical Information

Material Groups

Please visit
globalyg1.com/mat
 for material search



Mat'l No.	JIS	DIN	Material Description			Composition / Structure / Heat Treatment					HB	HRC
			AISI/ASTM/SAE	BS	EN	Annealed					180	10
<div style="display: flex; justify-content: space-between; align-items: center;"> P VDI 3323 6 Material Description Low-alloyed Steel Composition / Structure / Heat Treatment Annealed HB 180 HRC 10 </div>												
Mat'l No.	JIS	DIN	AISI/ASTM/SAE	BS	EN	AFNOR	SS	UNI	UNE / IHA	UNS	GOST	Brands
1.0116		St 37-3	A570 Gr. 36	4360-40C	S 235 J2 G3	E24-3	1312	Fe 360 D1(2)	AE235D		ST3KP	
1.0904	SKH 1, SKT 4	55Si7	9255	250A53	45	55S7	2085	55Si8	56Si7	G92550	55S2	
1.0961	SUP 7	60SiCr7	9262			60SC6		60SiCr8	60SiCr8	G92620		
1.2067		100Cr6	L3	BL3		Y100C6			100Cr6			
1.2108		90CrSi5	L1				2092	105WCR5				
1.2210		115CrV3	L2			100C3		107CrV3KU	F.520L		11KHf	
1.2241		51CrV4										
1.2330	SCM435TK	35CrMo4	4135	708A37		34CD4	2234	35CrMo4			35KHM	
1.2419	SKS31	105WCr6		105WC13		105WC13	2140	10WCr6			CWG	
1.2510	SKS3	100MnCrW4	O1	BO1		90 MWCV 5	2140	95 MnWCr 5 KU	F.5220		9KHVG	
1.2542		45WCrV7	S1	BS1			2710	45WCrV8KU			5CW25F	
1.2550		60WCrV7	S1			55WC20	2710	58WCr9KU			5KHV25F	
1.2713	SKT4	55NiCrMoV6	L6			55NCDV7			F.520S		5C NM	
1.2721		50NiCr13	L6			55NCV6	2550		F.528			
1.2842		90MnCrV8	O2	BO2		90MV8				T31502	9G2F	
1.3501		100Cr2	E50100									
1.3505	SUJ2	100Cr6	52100	2S135	31	100C6	2258	100Cr6	F.1310		SCC 15	
1.5024		46Si7				45S7		46Si7	F.1451			
1.5025		51Si7	9259H		50Si7	51S7	2090	50Si7	F.1450			
1.5026		55Si7			56Si7	55S7	2085	55Si7	F.1440	G92550	55S2	
1.5027		60Si7	9260	251A60	60Si7	60S7		60Si7	F.1441	G92600	60S2	
1.5028	SUP7	65Si7	9260H									
1.5415	STFA 12	15Mo3	A204GrA	1503-243B		15D3	2912	16Mo3(KG)	F.2601	K11820		
1.5419	SCPH11	20Mo4	4419	1503-243-430			2512	G20Mo5		G44190		
1.5423	SB450M	16Mo5	4520	1503-245-420				16Mo5(KG)	F.2602	K11522		
1.5622		14Ni6	A350-LF5			16N6		14Ni6(KG)	F.2641			
1.5732	SNC415(H)	14NiCr10	3415			14NC11		16NiCr11				
1.5752	SNC815(H)	14NiCr14	3310	655M13	36A	12NC15					20X2H4A	
1.6511	SUP10	36CrNiMo4	9840	816M40	110	40NCD3		36NiCrMo4(KB)			40C N2MA	
1.6523	SNCM220(H)	21NiCrMo2	8620	805M20	362	20NCD2	2506	20NiCrMo2			20C GNM	
1.6546	SNCM240	40NiCrMo2-2	8740	311-Tyre7				40NiCrMo2(KB)			38C GNM	
1.6566		17NiCrMo6-4										
1.6587		17CrNiMo6		820A16		18NCD6		14NiCrMo13				
1.6657		10NiCrMo13-4						14NiCrMo131				
1.7015	SCr415(H)	10Cr3	5015	523M15		12C3				G50150	15C	
1.7033	SCr430(H)	34Cr4	5132	530A32	18B	32C4		34Cr4(KB)		G51300	35C	
1.7035	SCr440(H)	41Cr4	5140	530M40	18	42C4	2245	41Cr4		G51400	40H	
1.7131	SCR 415	16MnCr5	5115	527M17		16MCS	2511	16MnCr5		G51150	12KHn2	
1.7139		16MnCr55					2127				18HG	
1.7176	SUP9(A)	55Cr3	5155	527A60	48	55C3	2253	55Cr3			50C GA	
1.7218	SCM420	25CrMo4	4130	CDS110		25CD4	2225	25CrMo4(KB)			20C M	
1.7220	SCM432	34CrMo4	4135	708 A 37		35CD4	2234	34CrMo4			35C M	
1.7223	SNB22-1	41CrMo4	4142					41CrMo4			40C FA	
1.7225	SCM 440 (H)	42CrMo4	4140	708 M 40	42 CrMo 4	42 CD 4	2244	42 CrMo 4	F.1252		38HM	
1.7228		55NiCrMoV6G		823M30	33		2512	653M31				
1.7262	SCM415(H)	15CrMo5				12CD4	2216	12CrMo4				
1.7321		20mOcr4					2625					
1.7335	SCM415(H)	13CrMo4-4	A182-F11	1501-620		15CD4-5	2216	14CrMo45			12C M	
1.7361		32CrMo12		722M24	40B	30CD12	2240	30CrMo12	F.124A			
1.7380		10CrMo9-10	A182F22	1501-622		12CD9-10	2218	12CrMo9			12KH8	

Technical Information

Material Groups

Please visit
globalyg1.com/mat
 for material search



Mat'l No.	JIS	DIN	Material Description			Composition / Structure / Heat Treatment					HB	HRC	
			AISI/ASTM/SAE	BS	EN	Low-alloyed Steel					Annealed	180	10
1.7715		14MoV6-3		1503-660-440				13MoCrV6					
1.8159	SUP 10	50CrV4	6150	735A50	47	50CrV4	2230	50CrV4		G61500	50C GFA		
1.8161		58CrV4											
1.8509	SACM 645	41CrAlMo7	A355A	905M39	41B	40CAD6-12	2940	41CrAlMo7					
1.8523		39CrMoV13-9		897M39	40C			36CrMoV12					

Mat'l No.	JIS	DIN	Material Description			Composition / Structure / Heat Treatment					HB	HRC
			AISI/ASTM/SAE	BS	EN	Low-alloyed Steel					Quenched & Tempered	275
1.5415	STFA 12	15Mo3	A204GrA	1503-243B		15D3	2912	16Mo3(KG)	F.2601	K11820		
1.5423	SB450M	16Mo5	4520	1503-245-420				16Mo5(KG)	F.2602	K11522		
1.5622		14Ni6	A350-LF5			16N6		14Ni6(KG)	F.2641			
1.5732	SNC415(H)	14NiCr10	3415			14NC11		16NiCr11				
1.5752	SNC815(H)	14NiCr14	3310	655M13	36A	12NC15				20X2H4A		
1.5755	SNC236	31NiCr14		653M31		18NC13	2534		F.1270			
1.6565	SNCM447	40NiCrMo6	4340	817M40	24	35NCD6	2541	35NiCrMo6(KB)		38C2N2MA		
1.6587		17CrNiMo6		820A16		18NCD6		14NiCrMo13				
1.6657		10NiCrMo13-4						14NiCrMo131				
1.6957		26NiCrMoV14-5										
1.7015	SCr415(H)	10Cr3	5015	523M15		12C3				G50150	15C	
1.7262	SCM415(H)	15CrMo5				12CD4	2216	12CrMo4				
1.7335	SCM415(H)	13CrMo4-4	A182-F11	1501-620		15CD4-5	2216	14CrMo45			12C M	
1.7380		10CrMo9-10	A182F22	1501-622		12CD9-10	2218	12CrMo9			12KH8	
1.7715		14MoV6-3		1503-660-440				13MoCrV6				
1.7733		24CrMoV55				20CDV6		21CrMoV511				
1.7755		GS-45CrMoV10-4										
1.8070		21CrMoV511						35NiCr9				

Mat'l No.	JIS	DIN	Material Description			Composition / Structure / Heat Treatment					HB	HRC
			AISI/ASTM/SAE	BS	EN	Low-alloyed Steel					Quenched & tempered	300
1.1730		C45W3	C45W			XC48						
1.2332	SCM(440)	47CrMo4	4142	708M40	19A	42CD4	2244	42CrMo4				
1.5736	SNC 631 (H)	36NiCr10	3435			30NC11						
1.6523	SNCM220(H)	21NiCrMo2	8620	805M20	362	20NCD2	2506	20NiCrMo2			20C GNM	
1.7033	SCr430(H)	34Cr4	5132	530A32	18B	32C4		34Cr4(KB)		G51300	35C	
1.7218	SCM420	25CrMo4	4130	CDS110		25CD4	2225	25CrMo4(KB)			20C M	
1.8515		32CrMo12		722M24	40B	30CD12	2240	32CrMo12	F.124A			

Technical Information

Material Groups

Please visit globalyg1.com/mat for material search 

Mat'l No.	JIS	DIN	AISI/ASTM/SAE	BS	EN	Composition / Structure / Heat Treatment					HB	HRC
						Material Description					Quenched & Tempered	
P												
VDI 3323 9												
Low-alloyed Steel												
Brands												
1.0904	SKH 1, SKT 4	55Si7	9255	250A53	45	55S7	2085	55Si8		G92550	55S2	
1.0961	SUP 7	60SiCr7	9262			60SC6		60SiCr8		G92620		
1.2067		100Cr6	L3	BL3		Y100C6		100Cr6				
1.2419	SKS31	105WCr6		105WC13		105WC13	2140	10WCr6			CWG	
1.2542		45WCrV7	S1	BS1			2710	45WCrV8KU			5CW25F	
1.2713	SKT4	55NiCrMoV6	L6			55NCDV7			F520S		5CNM	
1.4882		X50CrMnNiNbN219				Z50CMNNb21-09						
1.5120		38MnSi4										
1.5710	SNC236	36NiCr6	3135	640A35	111A	35NC6						
1.5755	SNC236	31NiCr14		830m31		18NC13	2534		F.1270			
1.6511	SUP10	36CrNiMo4	9840	816M40	110	40NCD3		36NiCrMo4(KB)			40C N2MA	
1.6546	SNCM240	40NiCrMo2-2	8740	311-Tyre7				40NiCrMo2(KB)			38C GNM	
1.7035	SCr440(H)	41Cr4	5140	530M40	18	42C4	2245	41Cr4		G51400	40H	
1.7176	SUP9(A)	55Cr3	5155	527A60	48	55C3	2253	55Cr3			50C GA	
1.7220	SCM432	34CrMo4	4135	708Aa37		35CD4	2234	34CrMo4			35C M	
1.7223	SNB22-1	41CrMo4	4142					41CrMo4			40C FA	
1.7225	SCM 440 (H)	42CrMo4	4140	708 M 40	42 CrMo 4	42 CD 4	2244	42 CrMo 4	F.1252		38HM	
1.7361		32CrMo12		722M24	40B	30CD12	2240	30CrMo12	F.124A			
1.8159	SUP 10	50CrV4	6150	735A50	47	50CrV4	2230	50CrV4	51CrV4	G61500	50C GFA	
1.8161		58CrV4										
1.8509	SACM 645	41CrAlMo7	A355A	905M39	41B	40CAD6-12	2940	41CrAlMo7				
1.8523		39CrMoV13-9		897M39	40C			36CrMoV12				

Mat'l No.	JIS	DIN	AISI/ASTM/SAE	BS	EN	Composition / Structure / Heat Treatment					HB	HRC
						Material Description					Annealed	
P												
VDI 3323 10												
High-alloyed steel, and tool steel												
Brands												
1.0347	SPCD	RR St 3	A619	CR 3	Fe P03	F 13		DC03/FeP03			08JU	
1.0723	SUM32	15S22		210A15			1922		F.210F			
1.2080	SKD1	X210Cr12	D3	BD3	X210Cr12	Z200C12		X205Cr12KU		T30403	KH12	
1.2162	SCR 420 H	21MnCr5				20MC5						
1.2311		40CrMnMo7				40CMD8		35CrM08KU				
1.2312		40CrMnMoS8.6	P20+S			40CMD8S						
1.2316		X36CrMo17			X38CrMo16							
1.2343	SKD 6	X38CrMoV5-1	H11	BH11		Z38CDV5		X37CrMoV51KU		T20811	4C 5MFS	
1.2344	SKD61	X40CrMoV5-1	H13	BH13		Z40CDV5	2242	X40CrMoV511KU	F.5318	T20813	4C 5MF1S	
1.2363	SKD12	X100CrMoV5-1	A2	BA2		Z100CDV5	2260	X100CrMoV51KU	F.5227		9KH5VF	
1.2379	SKD11	X155CrVMo121	D2	BD2		Z160CDV12	2310	X165CrMoW12KU		T30402	KH12MF	KRUPP2379
1.2436	SKD 2	X210CrW12	D4(D6)	BD6		Z200CD12	2312	X215CrW121KU	F.5213		KH12	

NEXT PAGE ►

Technical Information

Material Groups

Please visit
globalyg1.com/mat
 for material search



Mat'l No.	JIS	DIN	Material Description			Composition / Structure / Heat Treatment					HB	HRC
			AISI/ASTM/SAE	BS	EN	Annealed					200	15
<div style="display: flex; justify-content: space-between; align-items: center;"> P <div style="text-align: center;"> VDI 3323 10 </div> <div style="text-align: center;"> Material Description High-alloyed steel, and tool steel </div> <div style="text-align: center;"> Composition / Structure / Heat Treatment Annealed </div> <div style="text-align: center;"> HB 200 </div> <div style="text-align: center;"> HRC 15 </div> </div>												
Mat'l No.	JIS	DIN	AISI/ASTM/SAE	BS	EN	AFNOR	SS	UNI	UNE / IHA	UNS	GOST	Brands
1.2510	SKS3	100MnCrW4	O1	BO1		90 MWCV 5	2140	95 MnWCr 5 KU	F5220		9KHVG	
1.2581	SKD5	X30WCrV9-3	H21	BH21		Z30WCV9		X30WCrV93KU	F526	T20821	3C2W8F	
1.2601		X165CrMoV12					2310	X160CrMoV12			KH12MF	
1.2606	SKD 62	X37CrMoW51	H12	BH12		Z35CWDV5		X35CrMoW05KU	F537	T20812	5C NM	
1.2764		X19NiCrMo4										
1.2767		X45NiCrMo4				45NCD16		40NiCrMoV8KU				
1.2842		90MnCrV8	O2	B02		90MV8		90MnVCr8KU		T31502	9G2F	
1.3243	SKH55	S6-5-2-5	T15			KCV06-05-05-04-02	2723	HS6-5-2-5			R6M5K5	
1.3249	SKH 3	S18-1-2-5	T4	BT4		Z80WKCV18-05-04					R18K5F2	
1.3343	SKH51,SKH9	S6-5-2	M2	BM2		Z85WDCV	2722	HS652	F5604		R6M5	
1.3348	SKH 58	S2-9-2	M7			Z100DCWV09-04-02	2782	HS292	F5607			
1.3355	SKH 2	S18-0-1	T1	BT1		Z80WCV18-4-01					R18	
1.4718	SUH1	X45CrSi9-3	HNV3	401S45	52	Z45CS9		X45CrSi8	F322		40C 9S2	
1.5662	SL9N60(53)	X8Ni9	ASMA353	502-650		9Ni		X10Ni9	F2645			
1.5680		12Ni19	2515	12Ni19		Z18N5						

Mat'l No.	JIS	DIN	Material Description			Composition / Structure / Heat Treatment					HB	HRC
			AISI/ASTM/SAE	BS	EN	Quenched & Tempered					325	35
<div style="display: flex; justify-content: space-between; align-items: center;"> P <div style="text-align: center;"> VDI 3323 11 </div> <div style="text-align: center;"> Material Description High-alloyed steel, and tool steel </div> <div style="text-align: center;"> Composition / Structure / Heat Treatment Quenched & Tempered </div> <div style="text-align: center;"> HB 325 </div> <div style="text-align: center;"> HRC 35 </div> </div>												
Mat'l No.	JIS	DIN	AISI/ASTM/SAE	BS	EN	AFNOR	SS	UNI	UNE / IHA	UNS	GOST	Brands
1.2080	SKD1	X210Cr12	D3	BD3	X210Cr12	Z200C12		X205Cr12KU		T30403	KH12	
1.2344	SKD61	X40CrMoV5-1	H13	BH13		Z40CDV5	2242	X40CrMoV511KU	F5318	T20813	4C5MF15	
1.2363	SKD12	X100CrMoV5-1	A2	BA2		Z100CDV5	2260	X100CrMoV51KU	F5227		9KH5VF	
1.2436	SKD 2	X210CrW12	D4(D6)	BD6		Z200CD12	2312	X215CrW121KU	F5213		KH12	
1.2581	SKD5	X30WCrV9-3	H21	BH21		Z30WCV9		X30WCrV93KU	F526	T20821	3C2W8F	
1.2601		X165CrMoV12					2310	X160CrMoV12			KH12MF	
1.2714	SKT 4	55NiCrMoV7	6F3/L6			55NiCrMoV7			F5205		5KHNV	
1.3202		S12-1-4-5		BT15				HS12-1-5-5				
1.3207		S10-4-3-10		BT42		Z130WKCDV						
1.3243	SKH55	S6-5-2-5	T15			KCV06-05-05-04-02	2723	HS6-5-2-5			R6M5K5	
1.3246		S7-4-2-5	M35			Z110WKCDV07-05-04		HS7-4-2-5				
1.3247	SKH 51	S2-10-1-8	M42	BM42		Z110DKCWV09-08-04		HS2-9-1-8			R2AM9K5	
1.3255	SKH 3	S18-1-2-5	T4	BT4		Z80WKCV18-05-04					R18K5F2	
1.3343	SKH51,SKH9	S6-5-2	M2	BM2		Z85WDCV	2722	HS652	F5604		R6M5	
1.3348	SKH 58	S2-9-2	M7			Z100DCWV09-04-02	2782	HS292	F5607			
1.3355	SKH 2	S18-0-1	T1	BT1		Z80WCV18-4-01					R18	
1.4718	SUH1	X45CrSi9-3	HNV3	401S45	52	Z45CS9		X45CrSi8	F322		40C 9S2	
1.4935	SUH 616	X20CrMoWV121	422							S42200		
1.5680		12Ni19	2515	12Ni19		Z18N5						

Technical Information

Material Groups

Please visit globalyg1.com/mat for material search

M		VDI 3323		Material Description			Composition / Structure / Heat Treatment					HB	HRC
		12		Stainless steel			Ferritic / Martensitic, Annealed					200	15
Mat'l No.	JIS	DIN	AISI/ASTM/SAE	BS	EN	AFNOR	SS	UNI	UNE / IHA	UNS	GOST	Brands	
1.4000	SUS403	X6Cr13	403	403S17		Z6C13	2301	X6Cr13	F.3110	S40300	08C 13	ATI410S	
1.4001		X7Cr14	410 S	403S7		Z8C13	2301		F.8401		08C 13		
1.4002	SUS 405	X6CrAl13	405	405S17		Z6CA13	2302	X6CrAl13		S40500			
1.4005	SUS416	X12CrS13	416	416S21		Z11CF13	2380	X12CrS13	F.3411	S41600		ATI416	
1.4006	SUS410	X12Cr13	410	410S21	56A	Z10C13	2302	X12Cr13	F.3401	S41000	12C 13	ATI410	
1.4016	SUS430	X6Cr17	430	430S15	X8Cr17	Z8C17	2320	X8Cr17	F.3113	S43000	12C 17	ATI430	
1.4027	SCS 2	GX20Cr14		420C29		Z20C13M					20C 13L		
1.4028	SUS420J2	X30Cr13	420	420S45		Z30C13	2304			S42020	20C 13		
1.4034	SUS420J2	X46Cr13		420S45		Z40C14		X40Cr14	F.3405				
1.4057	SUS431	X19CrNi17-2	431	431S29	57	Z15CN16-02	2321	X16CrNi16	F.3427	S43100	20C 17N2	431 (HT)	
1.4086		GX12Cr29		452C11									
1.4104	SUS430F	X12CrMoS17	430F	420S37		Z10CF17	2383	X10CrS17	F.3117	S43020			
1.4112	SUS 440 B	X90CrMoV18	440B							S44003	95KH18		
1.4113	SUS434	X6CrMo17	434	434S17		Z8CD17-01	2325	X8CrMo17		S43400		AL 434	
1.4313	SCS5	X3CrNi13-4	CA6-NM	425C11		Z4CND13-04M	2385	(G)X6CrNi304		J91540			
1.4340		GX40CrNi274								J92615			
1.4417		X2CrNiMoS1195	S31500				2376			S39215			
1.4418		X4CrNiMo165				Z6CND16-04-01	2387					APX4	
1.4510	SUS430LX	X6CrTi17	XM8			Z4CT17		X6CrTi17	F.3115	S43035	08C 17T	430 Ti	
1.4511	SUS430LK	X6CrNb17				Z4CNb17		X6CrNb17	F.3122			AXC525	
1.4512	SUH409	X6CrTi12	409	LW19		Z3CT12		X6CrTi12		S40900			
1.4720		X20CrMo13											
1.4724	SUS 405	X10CrAl113	405	403S17		Z10C13		X10CrAl112	F.3111		10C 13SJU		
1.4742	SUS430	X10CrAl18	430	439S15	60	Z10CAS18		X8Cr17	F.3113	S43000	15C 13SJU		
1.4747	SUH4	X80CrNiSi20	HNV6	443S65	59	Z80CSN20-02		X80CrSiNi20	F.320B	S65006			
1.4749		X18CrNi28	446								15KH28		
1.4762	SUH446	X10CrAl124	446			Z10CAS24	2322	X16Cr26		S44600			
1.4871	SUH35,SUH36	X53CrMnNiN21-9	EV8	349S54		Z52CMN21-09		X53CrMnNiN219		S63008	55C 20G9AN4		
		X10CrNi15	429										
		X12CrNi18-9	302	302S31		Z10CN18-09	2330						

M		VDI 3323		Material Description			Composition / Structure / Heat Treatment					HB	HRC
		13		Stainless steel			Martensitic, Quenched & Tempered					240	23
Mat'l No.	JIS	DIN	AISI/ASTM/SAE	BS	EN	AFNOR	SS	UNI	UNE / IHA	UNS	GOST	Brands	
1.4000	SUS403	X6Cr13	403	403S17		Z6C13	2301	X6Cr13	F.3110	S40300	08C 13	ATI410S	
1.4001		X7Cr14	410 S	403S7		Z8C13	2301		F.8401		08C 13		
1.4006	SUS410	X12Cr13	410	410S21	56A	Z10C13	2302	X12Cr13	F.3401	S41000	12C 13	ATI410	
1.4016	SUS430	X6Cr17	430	430S15	X8Cr17	Z8C17	2320	X8Cr17	F.3113	S43000	12C 17	ATI430	
1.4021	SUS 420J1	X20Cr13	420	420S37		Z20C13	2303	14210	F.5261	S42000	20C 13	ATI420	
1.4027	SCS 2	GX20Cr14		420C29		Z20C13M					20C 13L		
1.4031	SUS 420 J2	X40Cr13	420			Z40C14	-2304		F.3404	S42080	40C 13		
1.4034	SUS420J2	X46Cr13		420S45		Z40C14		X40Cr14	F.3405				
1.4057	SUS431	X19CrNi17-2	431	431S29	57	Z15CN16-02	2321	X16CrNi16	F.3427	S43100	20C 17N2	431 (HT)	
1.4104	SUS430F	X12CrMoS17	430F	420S37		Z10CF17	2383	X10CrS17	F.3117	S43020			
1.4113	SUS434	X6CrMo17	434	434S17		Z8CD17-01	2325	X8CrMo17		S43400		AL 434	
1.4313	SCS5	X3CrNi13-4	CA6-NM	425C11		Z4CND13-04M	2385	(G)X6CrNi304		J91540			
1.4544		A 700	321	S.524		Z 10 CNT 18 11		X6CrNiTi1811		J92630	08C 18N12T		
1.4546		X5CrNiNb18-10	348	347S31				X6CrNiNb1811		J92640		ATI348	
1.4871	SUH35,SUH36	X53CrMnNiN21-9	EV8	349S54		Z52CMN21-09		X53CrMnNiN219		S63008	55C 20G9AN4		
1.4922		X20CrMnV12-1					2317	x20CrMnOn11201					
1.4923		X22CrMoV121										Jethete X20	

Technical Information

Material Groups

Please visit globalyg1.com/mat for material search

M		VDI 3323		Material Description			Composition / Structure / Heat Treatment					HB	HRC
		14		Stainless steel			Austenitic					180	10
Mat'l No.	JIS	DIN	AISI/ASTM/SAE	BS	EN	AFNOR	SS	UNI	UNE / IHA	UNS	GOST	Brands	
1.4301	SUS 304	X5CrNi18-10	304	304S15		Z5CN18-09	2332		F3551	S30409	08C 18N10		
1.4305	SUS303	X10CrNiS18-10	303	303S21	58M	Z8CNF18-09	2346	X10CrNiS18.09	F3508	S30300	30C 18N11	ATI 303	
1.4306	SCS19	X2CrNi1911	304L	304C12	X3CrNi1810KD	Z2CN18-09	2352	GX2CrNi1910	F3503	S30403	03KH18N11	ATI 304L	
1.4308	SUS304L	GX6CrNi18-9	CF-8	304C15	58E	Z6CN18-10M	2333					CF-8	
1.4310	SUS 301	X10CrNi18-8	301	301S21		Z12CN17-07	2331	X2CrNi1807	F3517	S30100	07KH16N6	ATI 301	
1.4311	SUS304LN	X2CrNiN18 10	304LN	304S62		Z2CN18-10	2371	X2CrNiN1810	F3541	S30453	03KH18N11		
1.4312	SCS12	GX10CrNi188	305	302C25		Z10CN18-9M					10C 18N9L	ATI 305	
1.4350	SUS304	X5CrNi18-9	304	304S15	58E	Z6CN18-09	2332	X5CrNi1810	F3551	S30400		ATI 304	
1.4362		X2CrNiN234	S32304			Z2CN23-04AZ	2327			S32304		ATI 2304TM	
1.4371		X3CrMnNiN18887	202	284S16		Z8CMN18-08-05							
1.4401	SUS316	X5CrNiMo17-12-2	316	316S13		Z3CND17-11-01	2347	X5CrNiMo17 12 2	F3534	S31600	08KH17H13M2T	ATI 316	
1.4404	SUS316L	X2CrNiMo17-13-2	316L	316S11		Z2CND17-12	2348	X2CrNiMo1712	F3533	S31603		ATI 316L	
1.4406	SUS316LN	X2CrNiMoN17122	316LN	316S61		Z2CND17-12AZ		X2CrNiMoN1712	F3542	S31653	07C 18N	ATI 316LN	
1.4408	SCS14	GX6CrNiMo18-10	CF-8M	316C16			2343	X7CrNiMo2010	F8414	J92900	10G2S2MSL		
1.4410	SCS 14 A	GX10CrNiMo18-9				Z5CND20-12M	2328			S32750			
1.4429	SUS316LN	X2CrNiMoN17-13-3	316Ln	316S62		Z2CND17-13AZ	2375	X2CrNiMoN17133	F3543		03KH16N15M3		
1.4435	SUS316L	X2CrNiMo18143	316L	316S11		Z3CND17-12-03	2375	X2CrNiMo17 13 2	F3533	S31603	03C 17N14M3		
1.4436	SUS316	X3CrNiMo17-13-3	316	316S19		Z6CND18-12-03	2343	X5CrNiMo17 12 2	F3543	S31600			
1.4438	SUS317L	X2CrNiMo18164	317L	317S12		Z2CND19-15-04	2367	X2CrNiMo18 16 4	F3539	S31703		ATI 317L	
1.4439		X2CrNiMoN17135	(s31726)			Z3CND18-14-06AZ							
1.4440		X2CrNiMo18-16											
1.4449	SUS317	X5CrNiMo17133	317	317S16				X5CrNiMo1815		S31700		ATI 317	
1.4460	SUS 329 J1	X8CrNiMo275	329				2324			S32900		10RE51	
1.4462	SUS329J3L	X2CrNiMoN2253		318S13		Z3CND22-05Az	2377			S31803		ATI 2205TM	
1.4500		X7NiCrMoCuNb2520				Z3NCDU25-20M				J95150			
1.4521	SUS444	X2CrMoTi18-2	443444				2326	X2CrMoTiN18 2	F3123				
1.4539		X1NiCrMoCuN25205				Z2NCDU25-20	2562			N08904		ATI 904L	
1.4541	SUS321	X14CrNiTi18-10	321	321S31		Z6CNT18-10	2337	X6CrNiTi18 11	F3523	S32100	06C 18N10T	ATI 321	
1.4542	SUS630	X5CrNiCuNb174	630			Z7CNU15-05						UGIMA 4542	
1.4545		Z7CNU15.05	15-5PH							S15500		ATI 15-5	
1.4547		X1CrNiMoN20187	S31254				2378			S31254		UranusB256Mo	
1.4550	SUS347	X6CrNiNb18-10	347	347S17	58F	Z6CNNb18-10	2338	X6CrNiNb 18 11	F3552	S34700	08C 18N12B	ATI 347	
1.4552	SCS 21	GX7CrNiNb18-9				Z4CNNb19-10M				J92710			
1.4568	SUS 631	X7 CrNiAl 177		316S111		Z9 CAN 17-7	2388	Z8CNA17-07		S17700	09C 17NJU1	17-7PH	
1.4571	SUS 316Ti	X6CrNiMoTi17-12-2	316Ti	320S31	58J	Z6NDT17-12	2350	X6CrNiMoTi17 12	F3535		10C 17N13M2T	ATI 316Ti	
1.4581	SCS 22	GX5CrNiMoNb18		318C17		Z4CNDNb18-12M							
1.4583		X6CrNiMoNb18-12	318	303S21		Z15CNS20-12		X15CrNiSi2 12					
1.4585		GX7CrNiMoCuNb1818						X6CrNiMoTi17 12		J94651			
1.4821		X20CrNiSi254				Z20CNS25-04				S44635			
1.4823		GX40CrNiSi274								J92605			
1.4828	SCS17	X15CrNiSi20-12	309	309S24	58C	Z15CNS20-12			F8414	S30900	20C 20N1452	ATI 309	
1.4833	SUS 309 S	X6CrNi2213	309S	309S13		Z15CN24-13				J93400			
1.4845	SUH310	X12CrNi25-21	310S	310S24		Z12CN25-20	2361	X6CrNi2520	F331	S31008	20C 23N18	ATI 310S	
1.4878	SUS321	X12CrNiTi18-9	321	321S20	58B	Z6CNT18-12(B)	2337	X6CrNiTi1811	F3553	S32100		ACX315	
1.4891		X5CrNiNb18-10	Ss30415				2372						
1.4893		X8CrNiNb11	S30815				2368						
1.4948		X6CrNi1811	304H	304S51		Z5CN18-09	2333			S30480			
1.4980		X5NiCrTi2515	660				2570			S66286		Incoloy A 286	
		X5NiCrN3525											
		X2CrNiMoN18134	S31753										
		X2CrNiMoN25227											

Technical Information

Material Groups

Please visit
globalyg1.com/mat
 for material search



K		VDI 3323 15		Material Description			Composition / Structure / Heat Treatment					HB	HRC
				Grey cast iron			Pearlitic / Ferritic					180	10
Mat'l No.	JIS	DIN	AISI/ASTM/SAE	BS	EN	AFNOR	SS	UNI	UNE / IHA	UNS	GOST	Brands	
0.6010	FC100	GG10	A48 20 B	Grade 100	GJL-100	Ft 10 D	0100	G10	FG10		Sc 10		
0.6015	FC150	GG15	A48 25 B	Grade 150	GJL-150	Ft 15 D	0115	G15	FG15		Sc 15		
0.6020	FC200	GG20	A48 30 B	Grade 220	GJL-200	Ft 20 D	0120	G20	FG20	W06020	Sc 20		
0.6025	FC250	GG25	A48 40 B	Grade 260	GJL-250	Ft 25 D	0125	G25	FG25		Sc 25		
0.6660		GGL-NiCr 20 2	1050/700/7	Grade F2	GJLA-XNiCr 20-2	L-NC 202	0523	-		F41002		Ni-Resist 2	
1.4449	SUS317	X5CrNiMo17133	317	317S16				X5CrNiMo1815		S31700		ATI317	

K		VDI 3323 16		Material Description			Composition / Structure / Heat Treatment					HB	HRC
				Grey cast iron			Pearlitic (Martensitic)					260	26
Mat'l No.	JIS	DIN	AISI/ASTM/SAE	BS	EN	AFNOR	SS	UNI	UNE / IHA	UNS	GOST	Brands	
0.6025	FC250	GG25	A48 40 B	Grade 260	GJL-250	Ft 25 D	0125	G25	FG25		Sc 25		
0.6030	FC300	GG30	A48 45 B	Grade 300	GJL-300	Ft 30 D	0130	G30	FG30		Sc 30		
0.6035	FC350	GG35	A48 50 B	Grade 350	GJL-350	Ft 35 D	0135	G35	FG35		Sc 35		
0.6040	FC400	GG40	A48 60 B	Grade 400	GJL-400	Ft 40 D	0140	G40	FC40		Sc 40		

K		VDI 3323 17		Material Description			Composition / Structure / Heat Treatment					HB	HRC
				Nodular cast iron			Ferritic					160	3
Mat'l No.	JIS	DIN	AISI/ASTM/SAE	BS	EN	AFNOR	SS	UNI	UNE / IHA	UNS	GOST	Brands	
0.7033	FCD350-22L	GGG35.3	-	350/22L40	GJS-350-22-LT	FGS 370-17	0717-15	-					
0.7040	FCD400	GGG40	60-40-18	SNG 420-12	GJS-400-15	FCS 400-12	0717-02	GS 400-12	FG E38-17	F32800	Vc 42-12		
0.7043	FCD 370	GGG40.3	60-40-18	SNG 370-17	GJS-400-18-LT	FGS 370-17	0717-12	GSO 42-17			Vc 42-12		
0.6040	FC400	GG40	A48 60 B	Grade 400	GJL-400	Ft 40 D	0140	G40	FC40		Sc 40		

K		VDI 3323 18		Material Description			Composition / Structure / Heat Treatment					HB	HRC
				Nodular cast iron			Pearlitic					250	25
Mat'l No.	JIS	DIN	AISI/ASTM/SAE	BS	EN	AFNOR	SS	UNI	UNE / IHA	UNS	GOST	Brands	
0.7050	FCD500	GGG50	80-55-06	SNG 500-7	GJS-500-7	FGS 500-7	0727-02	GS 500-7	FG E50-7	F33100	Vc 50-2		
0.7060	FCD600	GGG60	80-55-06	SNG 600-3	GJS-600-3	FGS 600-3	0732-03	GS 600-3	FG E60-2		Vc 60-2		
0.7070	FCD700	GGG70	100-70-03	SNG 700-2	GJS-700-2	FGS 700-2	0737-01	GS 700-2	FG S70-2	F34800	Vc 70-2		
0.7652	FCDA-NiMn 13 7	GGG NiMn 13-7	-	Grade S6	GJSA-XNiMn 13-7	FGS Ni13 Mn7	0772	-				Nodumag	
0.7660		GGG NiCr 20-2	A436 D2	Grade S2	GJSA-XNiCr 20-2	FGS Ni20 Cr2	0776	-				Ni-Resist D-2	

Technical Information

Material Groups

Please visit
globalyg1.com/mat
 for material search



Mat'l No.	JIS	DIN	AISI/ASTM/SAE	BS	EN	AFNOR	SS	UNI	UNE / IHA	UNS	GOST	Brands	K	VDI 3323	Material Description	Composition / Structure / Heat Treatment	HB	HRc
0.8135	FCMW330	GTS-35	32510	B 340-12	GJMB350-10	MN 35-10	0815	GMN 35	GTS35		Kc 35-10							

Mat'l No.	JIS	DIN	AISI/ASTM/SAE	BS	EN	AFNOR	SS	UNI	UNE / IHA	UNS	GOST	Brands	K	VDI 3323	Material Description	Composition / Structure / Heat Treatment	HB	HRc
0.8145	FCMW370	GTS-45	A220-40010	P 440-7	GJMB450-6	MN 450	0852	GMN 45										
0.8155	FCMP490	GTS-55	50005	P 510-4	GJMB-550-4	MP 50-5	0854	GMN 55			Kc 60-3							
0.8165	FCMP590	GTS-65	70003	P 570-3	GJMB-650-2	MN 650-3	0856	GMN 65										
0.8170	FCMP690	GTS-70	90001	P 690-2	GJMB-700-2	MN 700-2	0862	GMN 70			Kc 70-2							

Technical Information

Material Groups

Please visit
globalyg1.com/mat
 for material search



N		VDI 3323 21	Material Description Aluminum-wrought alloy				Composition / Structure / Heat Treatment Not Curable					HB 60	HRC
Mat'l No.	JIS	DIN	AISI/ASTM/SAE	BS	EN	AFNOR	SS	UNI	UNE / IHA	UNS	GOST	Brands	
3.0205		Al99	Al99										
3.0255	(A1050)	Al99.5	1000	L31		A59050C					D1		
3.3315		AlMg1											

N		VDI 3323 22	Material Description Aluminum-wrought alloy				Composition / Structure / Heat Treatment Curable, Hardened					HB 100	HRC
Mat'l No.	JIS	DIN	AISI/ASTM/SAE	BS	EN	AFNOR	SS	UNI	UNE / IHA	UNS	GOST	Brands	
3.1325		AlCuMg1									AD35		
3.1655	A2011	AlCuSiPb											
3.2315		AlMgSi1									AK9		
3.4345		AlZnMgCuO,5	7050	L86		AZ4GU/9051		811-04					
3.4365	7075	AlZnMgCu1,5	7075	7075		7075		AlZn5.8MgCuCr			B95		

N		VDI 3323 23	Material Description Aluminum-cast, alloyed				Composition / Structure / Heat Treatment ≤ 12% Si, Not Curable					HB 75	HRC
Mat'l No.	JIS	DIN	AISI/ASTM/SAE	BS	EN	AFNOR	SS	UNI	UNE / IHA	UNS	GOST	Brands	
3.2163		G-AlSi9Cu3									VAL8		
3.2382		GD-AlSi10Mg											
3.2383		G-AlSi0Mg(Cu)	A360.2	LM9			4253						
3.2581		G-AlSi12											
3.3561		G-AlMg5											
3.5101		G-MgZn4sE1Zr1	ZE41	MAG5									
3.5103		MgSE3Zn27r1	EZ33	MAG6		G-TR3Z2							
3.5812		G-MgAl8Zn1	AZ81	NMAG1									
3.5912		G-MgAl9Zn1	AZ91	MAG7									
			A356-72	2789		NFA32-201							
	A5052		356.1	LM25			4244				AK7		
		G-AlSi12	A413.2	LM6			4261						
	ADC12	G-AlSi12(Cu)	A413.1	LM20			4260				AK12		
	A6061	GD-AlSi12	A413.0				4247						
	A7075	GD-AlSi8Cu3	A380.1	LM24			4250						

Technical Information

Material Groups

Please visit
globalyg1.com/mat
 for material search 

N		VDI 3323 24	Material Description			Composition / Structure / Heat Treatment					HB	HRc
			Aluminum-cast, alloyed			≤ 12% Si, Curable, Hardened					90	
Mat'l No.	JIS	DIN	AISI/ASTM/SAE	BS	EN	AFNOR	SS	UNI	UNE / IHA	UNS	GOST	Brands
2.1871		G-AlCu4TiMg										
3.1754		G-AlCu5Ni1,5										
3.2371		G-AlSi7Mg	4218B								AK8	
3.2373	C4BS	G-AlSi9MgWA	SC64D			A-S7G	4251				AK9	
3.2381		G-AlSi10Mg									AK12	
3.5106		G-MgAg3SE2Zr1	QE22	mag12								
		G-ALMG5	GD-AISI12	LM5		A-SU12	4252					

N		VDI 3323 26	Material Description			Composition / Structure / Heat Treatment					HB	HRc
			Copper and Copper Alloys (Bronze / Brass)			Cutting alloys, PB>1%					110	
Mat'l No.	JIS	DIN	AISI/ASTM/SAE	BS	EN	AFNOR	SS	UNI	UNE / IHA	UNS	GOST	Brands
2.0375		CuZn36Pb3									LS60-2	
2.1090		G-CuSn75pb	C93200			U-E7Z5pb4						
2.1096		G-CuSn5ZnPb	c83600	LG2								
2.1098		G-CuSn2Znpb	C83600									
2.1182		G-CuPb15Sn	C23000	LB1		U-pb15E8						

N		VDI 3323 27	Material Description			Composition / Structure / Heat Treatment					HB	HRc
			Copper and copper alloys (Bronze / Brass)			CuZn, CuSnZn (Brass)					90	
Mat'l No.	JIS	DIN	AISI/ASTM/SAE	BS	EN	AFNOR	SS	UNI	UNE / IHA	UNS	GOST	Brands
2.0240	C2300	CuZn15									L90	
2.0321		CuZn37	C27200	cz108		CuZn36,CuZn37		C2700			L63	
2.0590		G-CuZn40Fe										
2.0592		G-CuZn35Al1	C86500	U-Z36N3		HTB1						
2.0596		G-CuZn34Al2	C86200	HTB1		U-Z36N3					LTS23AD	
2.1293		CuCrZr	C18200	CC102		U-Cr0-8Zr						

N		VDI 3323 28	Material Description			Composition / Structure / Heat Treatment					HB	HRc
			Copper and copper alloys (Bronze / Brass)			CuSn, lead-free copper and electrolytic copper					100	
Mat'l No.	JIS	DIN	AISI/ASTM/SAE	BS	EN	AFNOR	SS	UNI	UNE / IHA	UNS	GOST	Brands
2.0060		E-Cu57										
2.0966		CuAl10Ni5Fe4	C63000	Ca104		U-A10N					BrAD	
2.0975		G-CuAl10Ni	B-148-52									
2.1050		G-CuSn10	c90700	CT1								
2.1052		G-CuSn12	C90800	pb2		UE12P						
2.1292		G-CuCrF35	C81500	CC1-FF								

Technical Information

Material Groups

Please visit
globalyg1.com/mat
 for material search



Mat'l No.	JIS	DIN	AISI/ASTM/SAE	BS	EN	AFNOR	SS	UNI	UNE / IHA	UNS	GOST	Brands	VDI 3323 31			
													Material Description	Composition / Structure / Heat Treatment	HB	HRC
													Heat resistant super alloys	Fe Based, Annealed	200	15
1.4558	NCF 800TB	X2NiCrAlTiB3220	N08800	NA15												
1.4562		X1NiCrMoCu32287	N08031													
1.4563		X1NiCrMoCuN31274	N08028			Z1NCDU31-27-03	2584					EK77				
1.4864	SUH330	X12NiCrSi36-16	330	NA17			Z12NCS37-18					N08330				
1.4865	SCH15	GX40NiCrSi38-18			330C40				XG50NiCr3919				J94605			
1.4958		X5NiCrAlTiB120														

Mat'l No.	JIS	DIN	AISI/ASTM/SAE	BS	EN	AFNOR	SS	UNI	UNE / IHA	UNS	GOST	Brands	VDI 3323 32			
													Material Description	Composition / Structure / Heat Treatment	HB	HRC
													Heat resistant super alloys	Fe Based, Aged	280	30
1.4977		X40CoCrNi2020				Z42CNKDWNb										

Mat'l No.	JIS	DIN	AISI/ASTM/SAE	BS	EN	AFNOR	SS	UNI	UNE / IHA	UNS	GOST	Brands	VDI 3323 33			
													Material Description	Composition / Structure / Heat Treatment	HB	HRC
													Heat resistant super alloys	Ni or Co Based, Annealed	250	25
2.4360		NiCu30Fe			NA13	NU30					N04400	Monel400				
2.4603		NiCr 30 FeMo	5390A				NC22FeD						Hastelloy G-30			
2.4610		NiMo16Cr16Ti								N26455	HastelloyC-4					
2.4630		NiCr20Ti			HR5,203-4	NC20T					N06075	Nimonic75				
2.4631	NCF 80A	NiCr20TiAl			HR40	NC20TA				N07080	KHN77TYuR	Nimonic 80A				
2.4642	NCF 690	NiCr29Fe				Nnc30Fe					N06690	Inconel 690				
2.4856		NiCr22Mo9Nb			NA21	NC22FeDNb				N06625		Inconel 625				
2.4858		NiCr21Mo			NA16	NC21FeDU				N08825	KHN38VT	Incoloy 825				

Mat'l No.	JIS	DIN	AISI/ASTM/SAE	BS	EN	AFNOR	SS	UNI	UNE / IHA	UNS	GOST	Brands	VDI 3323 34			
													Material Description	Composition / Structure / Heat Treatment	HB	HRC
													Heat resistant super alloys	Ni or Co Based, Aged	350	38
2.4375		NiCu30Al	4676	NA18			NU30AT					N05500	Monelk500			
2.4662		NiFe35Cr14MoTi	5660				ZSNCDT42					N09901	Incoloy 901			
2.4668		NiCr19Fe19NbMo	5383	HR8			NC19eNB					N07718	Inconel 718			
2.4670		S-NiCr13A16MoNb	5391	Mar-46			NC12AD						Nimocast 713			
2.4694		NiCr16Fe7TiAl								N07751	Inconel 751					
2.4955		NiFe25Cr20NbTi														
2.4964		CoCr20W15Ni	5772			KC20WN							Haynes 25			
		CoCr22W14Ni	AMS 5772			KC22WN										

Technical Information

Material Groups

Please visit
globalyg1.com/mat
for material search



S		VDI 3323		Material Description			Composition / Structure / Heat Treatment					HB	HRc
		35		Heat resistant super alloys			Ni or Co Based, Cast					320	34
Mat'l No.	JIS	DIN	AISI/ASTM/SAE	BS	EN	AFNOR	SS	UNI	UNE / IHA	UNS	GOST	Brands	
2.4669		NiCr15Fe7TiAl				NC15TNbA				N07750		Inconel X750	
2.4685		G-NiMo28								N10665		Hastelloy B	
2.4810		G-NiMo30										Hastelloy C	
2.4973		NiCr19Co11MoTi	AMS 5399			NC19KDT					VT5-1		
3.7115		TiAl5Sn2								R54520	VT1-00	ATI Grade 6	

S		VDI 3323		Material Description			Composition / Structure / Heat Treatment					HB	HRc
		36		Titanium alloys			Pure Titanium					400 Rm	
Mat'l No.	JIS	DIN	AISI/ASTM/SAE	BS	EN	AFNOR	SS	UNI	UNE / IHA	UNS	GOST	Brands	
2.4674		NiCo15Cr10MoAlTi	AMS 5397							N13100		IN 100	
3.7025		Ti1	R50250	2TA1						R50250		ATI30 CP Gr. 1	
3.7225		Ti1pd	R52250	TP1						R52250			

S		VDI 3323		Material Description			Composition / Structure / Heat Treatment					HB	HRc
		37		Titanium alloys			Alpha + Beta Alloys, Hardened					1050 Rm	
Mat'l No.	JIS	DIN	AISI/ASTM/SAE	BS	EN	AFNOR	SS	UNI	UNE / IHA	UNS	GOST	Brands	
3.7124		TiCu2		2TA21-24									
3.7145		TiAl6Sn2Zr4Mo2Si	R54620							R54620			
3.7165		TiAl6V4	AMS R56400	TA10-13		T-A6V					VT6		
3.7185		TiAl4Mo4Sn2		TA45-51									
3.7195		TiAl3V2.5								R56320		ATI 3-2.5	
		TiAl4Mo4Sn4Si0.5											
		TiAl5Sn2.5	AMS R54520	TA14/17		T-A5E							
		Ti6Al4VELI	AMS R56401	TA11									

Technical Information

Material Groups

Please visit
globalyg1.com/mat
 for material search



H		VDI 3323 38	Material Description Hardened steel				Composition / Structure / Heat Treatment Hardened					HB 550	HRC 55
Mat'l No.	JIS	DIN	AISI/ASTM/SAE	BS	EN	AFNOR	SS	UNI	UNE / IHA	UNS	GOST	Brands	
1.1231	S70C-CSP	Ck 67	1070	060 A 67	C 67S	XC 68	1770	C 70	F5103		70		
1.1248	C 75	Ck 75	1078, 1080	060 A 78	C 75S	XC 75	1774	C 75	F5107		75		
1.1274	SUP 4	Ck 101	1095	060 A 96	C 100S	XC100	1870	C100	F5117				
1.1545	SK 3	C 105 W1	W1	BW 2	C 105U	Y1 105	1880	C 100 KU	F5118		U10A		
1.2762		75CrMoNiW67	-	-	-	-	-	-	-				
1.3401	SCMnH1	GX120Mn12	A128(A)			Z120M12	2183	GX120Mn12	F8251		110G13L		
1.4021	SUS 420 J1	X 20 Cr 13	420	420 S 37	X 20 Cr 13	Z 20 C 13	2303	X 20 Cr 13	F5261		20KH13	ATI 420	
1.4109	SUS 440 A	X 65 CrMo 14	440 A	-	X 70 CrMo 15	Z 70 D 14	-	-				ATI 440A	
1.4112	SUS 440 B	X 90 CrMoV 18	440 B	409 S 19	X 90 CrMoV 18	Z 2 CND 18 05	2327	X CrTi 12					
1.4125	SUS 440 C	X 105 CrMo 17	440 C	-	X 105 CrMo 17	Z 100 CD 17	-	X 105 CrMo 17			95KH18	ATI 440C	
1.6746		32NiCrMo14-5	-	832M31	32nCrMo145	35NCD14	-	-					
1.7176	SUP9(A)	55Cr3	5155	527A60	48	55C3	2253	55Cr3					
1.7225	SCM 440 (H)	42CrMo4	4140	708 M 40	42 CrMo 4	42 CD 4	2244	42 CrMo 4	F1252		38HM		

H		VDI 3323 40	Material Description Chilled cast iron				Composition / Structure / Heat Treatment Cast					HB 400	HRC 42
Mat'l No.	JIS	DIN	AISI/ASTM/SAE	BS	EN	AFNOR	SS	UNI	UNE / IHA	UNS	GOST	Brands	
0.9620		GX260NiCr42	A532 IB	Grade 2 A	GJN-HV520	FB Ni4 Cr2 BC	0512	-		F45001		Ni-Hard2	
0.9625		GX330NiCr42	A532 IA	Grade 2 B	GJN-HV550	FB Ni4 Cr2 HC	0513	-		F45000		Ni-Hard1	
0.9630		GX300CrNiSi 9 5 2	A532 ID	Grade 2 C	GJN-HV600	FB Cr9 Ni5	0457	-		F45003		Ni-Hard 4	
0.9640		GX300CrMoNi1521	-	-	-	-	-	-		F45005			
0.9650		GX260Cr27	-	Grade 3 D	-	-	0466	-					
0.9655		GX300CrNM0271	-	Grade 3 E	-	-	-	-			20C 25N20S2		
1.4841	SUH 310	X15CrNiSi25-20	310	314S31	X 15 CrNiSi 25 20	Z15CNS25-20	-	-		S31400		Cronifer 2520	

H		VDI 3323 41	Material Description Hardened cast iron				Composition / Structure / Heat Treatment Hardened					HB 550	HRC 55
Mat'l No.	JIS	DIN	AISI/ASTM/SAE	BS	EN	AFNOR	SS	UNI	UNE / IHA	UNS	GOST	Brands	
0.9635		GX300CrMo 15 3	-	-	-	-	-	-					
0.9645		GX260CrMoNi 20 21	-	-	-	-	-	-		F45007			

Technical Information

Comparison Chart - Turning Chipbreakers

Negative Inserts

Material	YG	Sandvik	Iscar	Kenna metal	Seco	Walter	Mitsu bishi	Kyocera	Tungaloy	Sumi tomo	Taegutec	Korloy	Duracarb
STEEL	UF	PF	F3P NF	FF FN	F1 MF2	FP5	FH LP	GP PP	TF	FL SP	FG FA	VF HU	41
	UL		PP NF			FP5	FY SY	CQ VF	TSF	LU	FC FT	HC	43
	UM		TF	MN	M3	MP3	MP	HS	TM	GU UX	MC PC	VM GM	46
	UG	PM	GN M3P	MN	M3 MR3	MP5	MP MA	PS	TM	UG	MT PC	GR HR	45
	UC	PR	NR	MP RP	MR4	RP5	Standard	Standard	TH	UZ	MG-	B25	53
	UR	PR	NR R3P	UN RN MG-	MR3 MR6	RP7	RP MH RK	PT PH	THS	ME MU	RT	GR	
STAINLESS STEEL	MF	MF	SF	FF	MF1	NF4	LM	MQ	SF HRF	SU	EA ML	HA	
	MM	MM	M3M	MP	MF3 MF4	NM4	MM	MS	SM	GU	EM	GS	42
	MR	MR	F3M	RF	M5	NR4	RM	MS MU	SH	EM	ET RT	RM	
CAST IRON	UC	PR	NR	MP RP	MR4	MK5	Standard	Standard	All Round	UZ	MG-	B25	53
	UR	PR	NR R3P	UN RN MG-	MR3 MR6	RK5 RK7	RP MH RK	PT PH	CH	ME MU	RT	GR	
	..MA			RP	MR7	..MA	MG-	C	CH	GZ	..MA		53

Positive Inserts

Material	YG	Sandvik	Iscar	Kenna metal	Seco	Walter	Mitsu bishi	Kyocera	Tungaloy	Sumi tomo	Taegutec	Korloy	Duracarb
STEEL	UF	PF	PF	LF UF	MF2	PF2 FP4	FM LM LP	GQ PP	01 PSF	FP	FG	HFP	41
	UG	PM		MF	MF3	MP4 FP6	MP Standard MM MV	HQ	PS PM	MU	MT	C25	51
STAINLESS STEEL	UF	PF	PF	LF	MF2	MM4 PS5	FM LM LP	GQ PP	PM	FP	FG	HFP	41
CAST IRON	UG	PM		UF	MF3	MK4 RK4	MP Standard MM MV	HQ	CM	MU	MT	C25	51
ALUMINUM	AL		AS	MF	AL	PF2 PM2	AZ	CF CK	AL	AG	FL	AK	AU

Technical Information

Comparison Chart - Turning Grades

ISO	YG	Sandvik	Iscar	Kenna metal	Seco	Walter	Mitsu bishi	Kyocera	Tungaloy	Sumi tomo	Taegutec	Korloy	Duracarb
P10	YG3010	GC4305	IC8005	KCP05	TP0501	WPP01	UE6105	CA5505	T9105	AC8015P	TT8115	NC3010	DC9015
		GC4205	IC428	KC9105	TP0500	WPP05S	MC6015	CA510	T9115	AC810P		NC3215	
		GC4315	IC8150	KCP10	TP1501	WPP10S	UE6110	CA515					
		GC4215	IC9015	KC9110	TP1500			CA5515					
P20	YG3020 (YG801)	GC4325	IC8250	KCP25	TP2501	WPP20S	MC6025	CA525	T9125	AC8025P	TT8125	NC3220	DC9025
		GC4225	IC9015	KC9125	TP2500		UE6020	CA5525		AC820P		NC3225	DC9025
P30	YG3030 (YG801)	GC4335	IC8350	KCP30	TP3501	WPP30S	MC6035	CA530	T9135	AC8035P	TT5100	NC3030	DC9025
		GC4235	IC8025	KC9140	TP3500		UE6035	CA5535	CR9025	AC630M	TT8135	NC5330	DC8035
M10	YG211	GC2015	IC807	KCS10	CP200	WSM10S	MC7015	CA6515	T6120	AC610M	TT9215	PC8105	
		GC1115	IC6015	KCM15(B)	TS2000		VP10RT	PR930	AH110	TT5080	PC8110		
M20	YG3030	GC2025	IC3028	KCM25(B)	TM2000	WMP20S	MC7025	CA6525	T6130	AC6030M	TT9225	PC8115	
		GC1125	IC808	KCU25	TS2500	WSM20S	VP15TF	PR1025	AH120	AC610M	TT9225	NC9115	
M30	YG213	GC2035	IC6025	KCM35(B)	CP500	WSM30S	US735	PR1535	AH630	AC6030M	TT9235	NC9125	DC8035
			IC8350				MP7035		SH730	AC630M	TT9020	NC5330	DC8035
M40	YG214				CP600		US735		AH645	AC6040M	TT9235	NC9135	
					TM4000		MP7035			AC530U	TT8020	TT8080	PC5400
K05	YG1001	GC3205	IC5005	KCK05	TK1001	WKK10S	MC5005	CA4505	T5105	AC405K	TT7005	NC6205	DC820
					TK1000		UC5105	CA4010				DC610	
K10	YG1001	GC3210	IC5010	KCK15	TK1001	WKK10S	MC5015	CA4515	T515	AC415K	TT7310	NC6210	
			IC5100		TK1000		UC5115	CA4115			TT7015		
K15	YG3010	GC3215	IC8150	KCK20	TK2001	WKK20S	UE6110	CA4120	T5125	AC420K	TT6300	NC6215	
					TK2000	WKP30S	VP15TF						
S10	YG211	GC1105	IC807	K313	TS2000	WSM10S	VP05RT	CA6515	AH110	AC510U	TT9215	PC8105	DC820
		S05F	IC808	K68	TS2050	WS10	MP9005	PR1305	AH120	TT5080	PC8110	DC610	
S20	YG213	GC1115	IC806	KCS10	TS2500	WSM20S	VP15TF	CA6525	AH8005	AC520U	TT9225	NC9125	
				KCU10	CP200	WSM21	VP20RT	PR1125	AH8015	TT9080	NC9135	PC5300	
S30	YG214	GC1125		KC5010	890	WSM30S	VP20RT	PR1325	AH725	AC520U	TT9235	PC5400	
					883			PR1535			TT8020	TT8080	

Technical Information

Comparison Chart - Milling Grades

ISO	YG-1	Sandvik	Iscar	Kennametal	Seco	Walter	Mitsubishi	Kyocera	Tungaloy	Sumitomo	Taegutec	Korloy
P20	YG712	GC4220 GC4230	IC950	KCPM20 KC522M	MP2500 MP3000 T250M	WKP25 WKP25S	MP6120 VP15TF	PR720 PR1025 PR1225	T3130 AH330 GH330	ACP200	TT7080 TT7030	NC5330 PC3500 PC3600
P30	YG622 YG602	GC1025 GC1030	IC808 IC907 IC908	KC522M KC635M KC927M	F25M F30M	WAM30 WKP35	MP6120 VP15TF MP6130 F7030	PR630 PR830 PR1230	AH725 AH730 AH120 GH130	ACP300 ACZ350	TT9080 TT9030	NC5340 NCM325 PC5300
M20	YG602	GC1125 GC1025 GC1030	IC808 IC907 IC908	KC522M KC635M	MP2500 F25M F30M	WQM35 WSM35S	VP15TF MP7130 VP20RT	PR730 PR1025 PR1225	T3030 AH725 AH120 AH4035	ACP200 ACM100 ACM200	TT9030 TT9080	NC5330 PC5300 PC9530 NC5340 NCM325
K10	YG5020	GC3330	IC5100	KC915M	MK1500 MP1500	WAK15	MP8010 MC5020			ACK100	TT7515	PC8110 PC6510
K20	YG622	GC3040	IC810 IC910	KCK15 KC520M	MK2050	WKK25	VP15TF	PR1210 PR1510	T1115 AH110	ACK200 ACK300	TT6080	NC5330 PC5300 NC5340
S20	YG602	S30T GC1025 S40T	IC328 IC907	KC510M KC635M	MS2050 MS2500	WSM35S WSP45S	MP9120 VP15TF	PR905 PR1025	AH725	AC520U	TT9030 TT8020	PC5300 PC5400

Search

Description	Page
INSERT	
ADKT	121
AOMT	121
APKT	122, 136
APMT	123
CCGT	78
CCMT	78
CNMA	60
CNMG	60
DCGT	79
DCMT	79
DNMA	63
DNMG	63
KNUX	66
ODMT	102
ODMW	102
OFER	103
OFMT	103
ONHU	104
ONMU	104
RBEX	132
RCMT	80
RDKT	129
RDKW	129
RDMT	130
RDMW	130
RPMT	131
RPMW	131
SCMT	81
SDCN	105
SDKN	105
SDMT	134
SDMW	134
SEKN	106
SEKR	106
SEKT	107
SEMT	108
SNMA	67
SNMG	67
SNMX	109
SPCN	110
SPKN	110
SPKR	110
SPMT	111
SPMX	146
SPUN	112
TCGT	82
TCMT	82
TDN	87
TDP	87
TDY	87
TNMA	69
TNMG	69
TNUX	72
TPCN	124
TPKN	124
TPKR	124
TPUN	125
VBMT	83

Description	Page
VCGT	84
VCMT	84
VNMA	73
VNMG	73
WCMX	147
WNMA	75
WNMG	75

MILLING CUTTER

...-ADKT15-...	113
...-AOMT12-...	113
...-APKT10-...	114
...-APKT10-... (Helical)	119
...-APKT16-...	116
...-APKT16-... (Taper)	135
...-APMT11-...	118
...-APMT16-...	118
...-M08-...	137
...-M10-...	137
...-M12-...	137
...-M16-...	137
...-ODMT06-...	99
...-OFER07-...	98
...-OFMT05-...	99
...-ONMU08-...	96
...-RDKT08-...	126
...-RDKT10-...	126
...-RDKT12-...	127
...-RPMT08-...	128
...-RPMT10-...	128
...-RPMT12-...	128
...-SDMW12-...	133
...-SE12T3-...	100
...-SEKT12-...	100
...-SNMX12-...	97
...-SPKN12-...	101
...-TPKN16-...	120
...-TPKN22-...	120

INSERT DRILL

YGWC	140
------	-----

TURNING HOLDER

CKJNR/L	33
MTJNR/L	39
MWLNR/L	43
PCBNR/L	30
PCLNR/L	30
PDJNR/L	32
PDNNN	32
PSBNR/L	36
PSDNN	36
PSKNR/L	36
PSSNR/L	36
PTFNR/L	38
PTGNR/L	38
PTJNR/L	39

Description	Page
PTTNR/L	38
PWLNR/L	43
SCACR/L	29
SCLCR/L	29
SDJCR/L	31
SDNCN	31
SRDCN	34
SRGCR/L	34
SSDCN	35
SSSCR/L	35
STFCR/L	37
STGCR/L	37
STJCR/L	37
STUCR/L	37
SVHBR/L	40
SVHCR/L	41
SVJBR/L	40
SVJCR/L	41
SVVBN	40
SVVCN	41
TCLNR/L	30
TDHNR/L	32
TDJNR/L	32
TDNNN	32
TSDNN	36
TSKNR/L	36
TSSNR/L	36
TTGNR/L	38
TTJNR/L	39
TVJNR/L	42
TVVNN	42
TWLNR/L	43
...-MTFNR/L	52
...-MTUNR/L	52
...-MWLNR/L	57
...-PCLNR/L	46
...-PDQNR/L	49
...-PDUNR/L	49
...-PSKNR/L	50
...-PTUNR/L	53
...-PWLNR/L	57
...-SCFCR/L	44
...-SCLCR/L	45
...-SDQCR/L	47
...-SDUCR/L	48
...-STFCR/L	51
...-STUCR/L	51
...-SVJBR/L	54
...-SVQBR/L	54
...-SVQCR/L	55
...-SVUBR/L	54
...-SVUCR/L	55
...-TCLNR/L	46
...-TDQNR/L	49
...-TDUNR/L	49
...-TTUNR/L	53
...-TVUNR/L	56
...-TWLNR/L	58

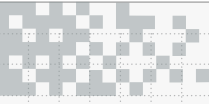

MEMO



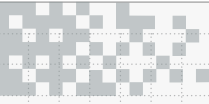

HIGH QUALITY PRODUCTS and ON TIME DELIVERY for WORLD-WIDE CUSTOMERS

Since 1982, YG-1 has been committed to quality, innovation and the unique customer experience.

Our performance and experience have granted YG-1 the global impression of one of the leading manufacturers of high quality cutting tool solutions. This global footprint expands over 75 countries, with international logistic centers, pledging to our customers to give the best service available today - and tomorrow.

EUROPE

 BELGIUM	 FINLAND	 ITALY	 PORTUGAL	 SLOVENIA	 THE NETHERLANDS
 CROATIA	 FRANCE	 LITHUANIA	 ROMANIA	 SPAIN	 TURKEY
 CZECH REPUBLIC	 GERMANY	 NORWAY	 RUSSIA	 SWEDEN	 UNITED KINGDOM
 DENMARK	 HUNGARY	 POLAND	 SERBIA	 SWITZERLAND	

ASIA PACIFIC

 AUSTRALIA	 INDONESIA	 KINGDOM OF SAUDI ARABIA	 SINGAPORE	 UNITED ARAB EMIRATES
 CHINA	 IRAN	 MALAYSIA	 SOUTH KOREA	 VIETNAM
 HONG KONG	 ISRAEL	 PAKISTAN	 TAIWAN	
 INDIA	 JAPAN	 PHILIPPINES	 THAILAND	

AMERICAS

 BRAZIL	 CANADA	 COLOMBIA	 MEXICO	 UNITED STATES
--	--	--	--	---

AFRICA

 EGYPT	 SOUTH AFRICA
---	--

YG-1 CO., LTD.

HEAD OFFICE

211, Sewolcheon-ro, Bupyeong-gu, Incheon, South Korea

Phone: +82-32-526-0909

Http://www.yg1.kr E-mail: yg1@yg1.kr



88400 Biberach/Riß • Joh.-Seb.-Bach-Str. 6
Tel. 0 73 51 / 1 20 69 • Fax 0 73 51 / 7 13 71
Info@Biber-Werkzeuge.de
www.Biber-Werkzeuge.de

Note The information is provided for reference only. Tool specifications are subject to change without prior notice.
Although we endeavor to supply accurate and timely information, there can be no guarantee to cover every particular application.
YG-1 or publishers are not liable for any damage for use of the information.



Search 'YG-1' on social media outlets